

Blue-White[®]

FLEXFLO[®]

Peristaltic Metering Pump

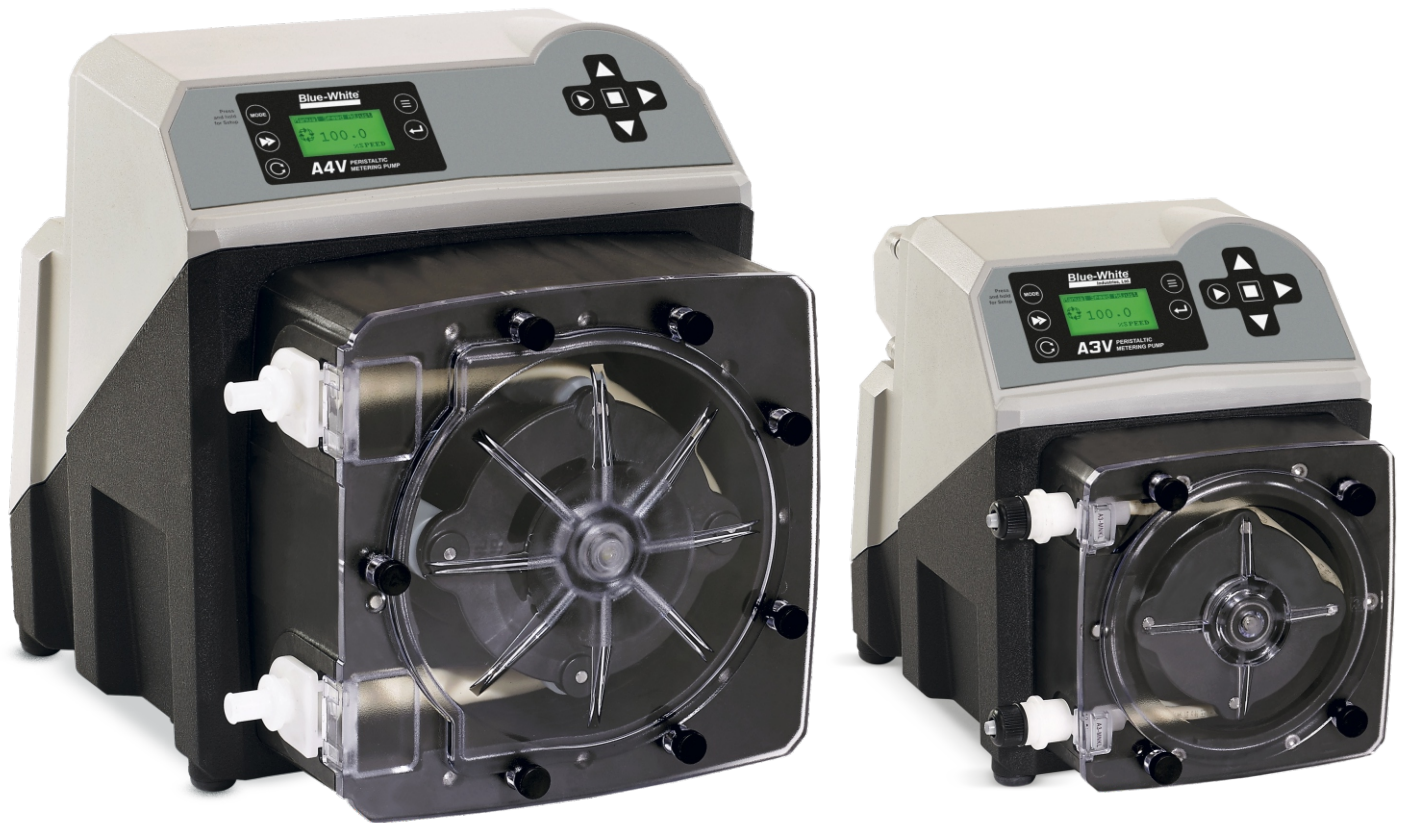

SERIES A3V and A4V

Operating Manual

Protected by Patents: 7,001,153;
7,284,964; 4,496,295
and other patents pending

5300 Business Drive, Huntington Beach, CA 92649 USA

Phone: 714-893-8529 FAX: 714-894-9492

E mail: sales@blue-white.com or customerservice@blue-white.com URL: www.blue-white.com

TABLE OF CONTENTS

1.0	Introduction.....	2
1.1	Available Models.....	3
1.2	Specifications.....	4
1.3	Materials of Construction.....	4
1.4	Features.....	5
1.5	Agency Listings.....	5
2.0	Installation.....	6
2.1	Mounting Location.....	6
2.2	Mounting Dimensions.....	6
2.3	Installing Injection Fitting and Strainer.....	7
2.4	Input Power Connections.....	8
2.5	Wiring Terminals and I/O Schematics.....	9
3.0	How to Operate Flex-Pro.....	10
3.1	Menu Navigation.....	11
3.2	Configuration Menu.....	12
3.2.1	Language Selection.....	12
3.2.2	Display Rate (units of measure).....	13
3.2.3	Reset Factory Defaults.....	13
4.0	Input Setup.....	14
4.1	Max RPM cut-off.....	15
4.2	Max Flowrate (Output Calibration).....	15
4.3	Input Setup (Operating Mode Configuration).....	16
4.3.1	Manual Adjust (manual speed adjust).....	16
4.3.2	4 - 20 mA Input.....	17
4.3.3	0 - 10 VDC Input.....	18
4.3.4	Frequency Input (Hz).....	19
4.3.5	Pulse Batch (low speed batch).....	20
4.3.6	Manual Cycle Adjust (repeating cycle timer).....	21
4.3.7	Dispensing.....	22
4.3.8	Manual Dosing.....	23
4.3.9	Proportional Dosing.....	24
4.4	Contact Closure Input (Remote start/stop).....	25
4.5	Set FVS (Flow Verification System).....	26
4.6	TFD (Tube Failure Detection).....	27
4.6.1	TFD Adjustment.....	27
4.7	Remote/Local Control.....	28
4.8	Pump Tube Timer.....	28
5.0	Output Setup (Alarm Relays & Output Signal signals).....	29
5.1	Signal Output.....	30
6.0	Pump Maintenance.....	31
6.1	Routine Inspection and Maintenance.....	31
6.2	How to Clean and Lubricate the Pump.....	31
6.3	Reverse Rotor Rotation.....	31
6.4	Tube Replacement.....	32
6.5	A3 Replacement Parts List.....	34
6.6	A4 Replacement Parts List.....	34
7.0	Tubing Data.....	36
7.1	Tube Life Estimates.....	36
7.2	Output Versus Fluid Viscosity.....	38

1.0 Introduction

Congratulations on purchasing the FlexFlo variable speed Peristaltic Metering Pump.

Your Flex-Pro pump is pre-configured for the tubing that shipped with your metering pump. The tubing assembly has an Identification number printed for easy re-order.

Please Note: Your new pump has been pressure tested at the factory with clean water before shipping. You may notice trace amounts of clean water in the pre-installed tube assembly. This is part of our stringent quality assurance program at Blue-White Industries.

1.1 Available Models

Feed Rate		Max Speed	Max Pressure	Max Temperature	A3 Model Numbers			
Flex-A-Prene® A3 Tube Pumps								
Meets FDA criteria for food Excellent chemical resistance CIP SIP								
GPH	LPH	ML/Min	RPM	PSI (bar)	F (C)	115V AC	230V AC	220V AC
.001 - 2.10	.003 - 7.8	.05 - 132	125	125 (8.6)	185 (85)	A3V24-*ND	A3V25-*ND	A3V26-*ND
.010 - 25.3	.038 - 96.0	.6 - 1596	125	125 (8.6)	185 (85)	A3V24-*NJ	A3V25-*NJ	A3V26-*NJ
.013 - 33.3	.050 - 126	.8 - 2100	125	125 (8.6)	185 (85)	A3V24-*NK	A3V25-*NK	A3V26-*NK
.013 - 33.3	.050 - 126	.8 - 2100	125	30 (2.1)	185 (85)	A3V24-*NKL	A3V25-*NKL	A3V26-*NKL
Flex-A-Prene® A3 Tube Pumps								
Meets FDA criteria for food Excellent chemical resistance Extra long tube life								
GPH	LPH	ML/MIN	RPM	PSI (bar)	F (C)	115V AC	230V AC	220V AC
.002 - 4.76	.007 - 18	.12 - 300	125	110 (7.6)	185 (85)	A3V24-*NEE	A3V25-*NEE	A3V26-*NEE
.007 - 19.02	.03 - 72	.48 - 1200	125	110 (7.6)	185 (85)	A3V24-*NGG	A3V25-*NGG	A3V26-*NGG
Flex-A-Chem® A3 Tube Pumps								
Meets FDA criteria for food Superior chemical resistance								
GPH	LPH	ML/Min	RPM	PSI (bar)	F (C)	115V AC	230V AC	220V AC
.006 - 15.06	.022 - 57.00	.4 - 950	125	50 (3.4)	130 (54)	A3V24-*TH	A3V25-*TH	A3V26-*TH
.011 - 28.5	.043 - 108	.72 - 1800	125	50 (3.4)	130 (54)	A3V24-*TK	A3V25-*TK	A3V26-*TK
Flex-A-Thane® A3 Tube Pumps								
Meets FDA criteria for food Resistant to oils, greases and fuels								
GPH	LPH	ML/Min	RPM	PSI (bar)	F (C)	115V AC	230V AC	220V AC
.002 - 4.6	.007 - 17.4	.1 - 290	125	65 (4.5)	130 (54)	A3F24-*GE	A3F25-*GE	A3F26-*GE
.004 - 10.1	.015 - 38.4	.3 - 637	125	65 (4.5)	130 (54)	A3F24-*GG	A3F25-*GG	A3F26-*GG
.010 - 24.9	.038 - 94.2	.6 - 1570	125	65 (4.5)	130 (54)	A3F24-*GH	A3F25-*GH	A3F26-*GH
.011 - 28.5	.043 - 108	.7 - 1800	125	65 (4.5)	130 (54)	A3F24-*GK	A3F25-*GK	A3F26-*GK
.007 - 18.23	.03 - 69.0	.46 - 1150	125	65 (4.5)	130 (54)	A3F24-*G2G	A3F25-*G2G	A3F26-*G2G
Feed Rate		Max Speed	Max Pressure	Max Temp	A4 Model Numbers			
Flex-A-Prene® A4 Tube Pumps								
Meets FDA criteria for food Excellent chemical resistance CIP SIP								
GPH	LPH	ML/Min	RPM	PSI (bar)	F (C)	115V AC	230V AC	220V AC
.01 - 28.5	.04 - 108	.7 - 1800	125	125 (8.6)	185 (85)	A4V24-*NH	A4V25-*NH	A4V26-*NH
.02 - 44.4	.07 - 168	1.1 - 2800	125	100 (6.9)	185 (85)	A4V24-*NJ	A4V25-*NJ	A4V26-*NJ
.02 - 50.7	.08 - 192	1.3 - 3200	125	80 (5.5)	185 (85)	A4V24-*NK	A4V25-*NK	A4V26-*NK
.02 - 54.0	.09 - 204	1.4 - 3400	125	100 (6.9)	185 (85)	A4V24-*NHH	A4V25-*NHH	A4V26-*NHH
.02 - 54.0	.09 - 204	1.4 - 3400	125	65 (4.5)	185 (85)	A4V24-*NHHL	A4V25-*NHHL	A4V26-*NHHL
.04 - 100.0	.15 - 378	2.5 - 6300	125	50 (3.4)	185 (85)	A4V24-*NL	A4V25-*NL	A4V26-*NL
.06 - 158.5	.24 - 600	4.0 - 10000	125	30 (2.0)	185 (85)	A4V24-*NP**	A4V25-*NP**	A4V26-*NP**
Flex-A-Chem® A4 Tube Pumps								
Meets FDA criteria for food Superior chemical resistance								
GPH	LPH	ML/Min	RPM	PSI (bar)	F (C)	115V AC	230V AC	220V AC
.02 - 54.00	.08 - 204.0	1.36 - 3400	125	30 (2.1)	130 (54)	A4V24-*TK	A4V25-*TK	A4V26-*TK
.05 - 126	.20 - 477	3.2 - 8000	125	30 (2.1)	130 (54)	A4V24-*TKK	A4V25-*TKK	A4V26-*TKK
Flex-A-Thane® A4 Tube Pumps								
Meets FDA criteria for food Resistant to oils, greases and fuels								
GPH	LPH	ML/Min	RPM	PSI (bar)	F (C)	115V AC	230V AC	220V AC
.01 - 39.6	.06 - 150	1.0 - 2500	125	65 (4.5)	130 (54)	A4V24-*GH	A4V25-*GH	A4V26-*GH
.02 - 55.5	.09 - 210	1.4 - 3500	125	65 (4.5)	130 (54)	A4V24-*GK	A4V25-*GK	A4V26-*GK
.04 - 100	.20 - 378	2.5 - 6300	125	65 (4.5)	130 (54)	A4V24-*GKK	A4V25-*GKK	A4V26-*GKK

- The Flex-Pro Pump's motor speed is linear over the entire 0.04% to 100% adjustment range.
- Output versus pressure is nearly linear in all models. Larger tubes exhibit greater losses.
- See the instruction manual for output versus viscosity curves.
- For optimum tube life, specify the pump to operate at the lowest possible RPM and pressure.
- Output based on testing with water at 72 F, 5 foot suction lift, atmospheric conditions at sea level.

- * Inlet/outlet connection type.
- ** NP flow rate reduced 16.5% with Quick Disconnect connections.
- S = 3/8" OD x 1/4" ID tubing compression type connections (A3 models only)
- M = 1/2" male NPT (available on A3 & A4 models)
- B = 1/2" ID tubing barb type connections (ND, NKL, NEE, NGG, G2G and A4 models only)
- C = 1/2" - 3/4" tri-clamp connections (ND, NKL, NEE, NGG, and G2G only)
- Q = Quick Disconnect (A3 Models ND, NKL, NEE, NGG, G2G, and A4 single Flex-A-Prene® tube models only) (Valves sold separately)

1.2 Specifications

Maximum working pressure (excluding pump tubes):

125 psig (8.6 bar)

Note: see individual pump tube assembly maximum pressure ratings.

Maximum Fluid temperature (excluding pump tubes):

185° F (85° C)

Note: see individual pump tube assembly maximum temperature ratings.

Ambient Operating Temperature

14°F to 115°F (-10°C to 46°C)

Ambient Storage Temperature

-40°F to 158°F (-40°C to 70°C)

Operating Voltage:

A3 MODELS:

115VAC/60Hz, 1ph (2.0 Amp Maximum)

230VAC/60Hz, 1ph (1.0 Amp Maximum)

220VAC/50Hz, 1ph (1.0 Amp Maximum)

240VAC/50Hz, 1ph (1.0 Amp Maximum)

A4 MODELS:

115VAC/60Hz, 1ph (3.1 Amp Maximum)

230VAC/60Hz, 1ph (1.6 Amp Maximum)

220VAC/50Hz, 1ph (1.6 Amp Maximum)

240VAC/50Hz, 1ph (1.6 Amp Maximum)

Power Cord Options:

115V60Hz = NEMA 5/15 (USA)

230V60Hz = NEMA 6/15 (USA)

220V50Hz = CEE 7/VII (EU)

240V50Hz = AS 3112 (Australia/New Zealand)

1.3 Materials of construction

Wetted components:

Pump Tube Assembly (Model Specific - 2 provided):

Tubing: Flex-A-Prene® or Flex-A-Chem® or Flex-A-Thane®

Adapter fittings: .PVDF

Injection / Back-flow Check valve:

Body & insert: PVDF

Check Ball: Ceramic

Spring: Hastelloy C-276

Ball Seat O-ring: TFE/P (optional EP)

Static Seal O-ring: TFE/P (optional EP)

Ancillary Items provided

With "S" tubing type connections only:

Suction Tubing: 3/8" OD x 1/4" ID x 10' Clear PVC

Discharge Tubing: 3/8" OD x 1/4" ID x 10' Polyethylene (LLDPE)

Suction Strainer: PVDF

With "B" tubing and "M" M/NPT connections only:

(Available on ND, NKL, NK, NGG, NEE, G2G and A4 only)

Suction Strainer:

Body: PVDF

Check Ball: Ceramic

Ball Seat O-ring: TFE/P (optional EP)

For "C" Tri-clamp and "Q" Quick Disconnect connections:

(Available on ND, NKL, NK, NGG, NEE, and G2G only)

No accessories provided

*Quick Disconnect Valves sold separately

Enclosure:

NEMA 4X (Ip66), Polyester powder coated aluminum.

Maximum Overall Dimensions:

A3 models: 8-1/8"W x 10-3/4"H x 15-1/4"D (20.6W x 27.3H x 38.9D cm)

A4 models: 12-1/8"W x 14-1/4"H x 18-5/8"D (30.8W x 36.1H x 47.3D cm)

Approximate shipping wt:

A3 models: 33 lb. (15.0 Kg)

A4 models: 58 lb. (26.3 Kg)

Motor speed adjustment range 2,500:1:

0.05% - 100% motor speed

Motor speed adjustment resolution:

0.1% increments > 10% motor speed

0.01% increments > 1% motor speed and < 10%

0.001% increments < 1% motor speed

Maximum viscosity:

12,000 Centipoise

Maximum suction lift:

30 ft. Water, 0 psig (9.14 m, 0 bar)

Display

3 color VGA backlit LCD, UV resistant.

Display Languages

English, Spanish, French or German selectable.

Keypad

Ten button positive action tactile switch keypad.

Security

Programmable 4-digit password.

Non-Wetted components:

Enclosure:

413 Aluminum (Polyester powder coated)

Pump Head:

Valox® (PBT) thermoplastic

Pump Head Cover:

Polycarbonate for added strength and chemical resistance.

Permanently lubricated sealed motor shaft support ball bearing.

Cover Screws:

Stainless Steel

Roller Assembly:

Rotor:Valox® (PBT)

Rollers:PVDF/Nylon

Roller Bearings:SS Ball Bearings

Motor Shaft:

Chrome plated steel

TFD System Sensor pins:

Hastelloy C-276

Power Cord:

3 conductor, SJTW-A Water-resistant

Tube Installation Tool:

GF Nylon

Mounting Brackets and Hardware:

316 Stainless Steel

1.4 Features

- Peristaltic pump design does not have valves that can clog requiring maintenance.
- Self priming - even against maximum line pressure. By-pass valves are not required. Cannot vapor lock or lose prime. Syphoning cannot occur.
- Output rates to: 158.5 GPH (600 LPH) and pressures to 125 PSI (8.6 Bar).
- No maintenance brushless variable speed motor.
- Specially engineered tubing for long life at high pressures.
- Patented Tube Failure Detection (TFD) system. Senses tube failure by detecting chemical in the pump head. No false triggering.
- 2500:1 turndown ratio.
- SCADA Inputs include: 4-20mA, 0-10Vdc, and Pulse inputs for remote external speed control and 0-30 VDC / contact closure remote start/stop.
- Operator friendly digital touch pad with menu driven software.
- VGA Graphic multi-color backlit LCD displays remote/local control status, motor speed, output rate, input signal values, service and alarm status.
- Outputs include: Scalable 4-20mA or pulse, one 250V/6A relay and three 115V/1A contact closures assignable to monitor up to 17 different pump functions including TFD, FVS, remote/local control setting, motor on, fault, current operating mode, and others.
- Two molded squeeze and alignment rollers for optimum squeeze, unparallelled accuracy, and tube life.
- Heavy duty rotor - single piece plastic rotor means no flexing and increased accuracy (no metal springs or hinges to corrode).
- Inject at maximum PSI in either direction (clockwise and counter clockwise).
- Patent pending feature for extended tube life.
- Compatible with Blue-White's output Flow Verification Sensor (FVS) system.

Enclosure Rating:

NEMA 4X: Constructed for either indoor or outdoor use to provide a degree of protection to personnel against incidental contact with enclosed equipment; to provide a degree of protection against falling dirt, rain, sleet, snow, windblown dust, splashing water, and hose-directed water; and that will be undamaged by external formation of ice on enclosure.

IP66: No ingress of dust; complete protection against contact. Water projected in powerful jets against enclosure from any direction shall have no harmful effects.

1.5 Agency Listings





This pump is ETL listed to conform to the following:
 UL Standard 778 as a motor operated water pump
 CSA Standard C22.2 as process control equipment



This pump complies to the Machinery Directive 98/37/EC, BS EN 60204-1, Low Voltage Directive 73/23/EC BS EN 61010-1, EMC Directive 89/336/EC, BS EN 50081-1/BS EN 50082-1.

Symbol	Explanation
	WARNING, risk of electric shock
	CAUTION, refer to users' guide
	GROUND, PROTECTIVE CONDUCTOR TERMINAL

2.0 Installation

CAUTION 	Risk of chemical overdose. Be certain pump does not overdose chemical during backwash and periods of no flow in circulation system.
CAUTION 	Always wear protective clothing, face shield, safety glasses and gloves when working on or near your metering pump. Additional precautions should be taken depending on solution being pumped. Refer to MSDS precautions from your solution supplier.
CAUTION 	All diagrams are strictly for guideline purposes only. Always consult an expert before installing metering pump on specialized systems. Metering pump should be serviced by qualified persons only.

2.1 Mounting Location

Choose an area located near chemical supply tank, chemical injection point, and electrical supply. Install pump where it can be easily serviced.

- 316SS Mounting brackets are included. Mount pump to a secure surface using enclosed mounting hardware.
- Mount pump close to injection point. Keep inlet (suction) and outlet (discharge) tubing as short as possible. Longer discharge tubing increases back pressure at pump head.
- A back flow prevention check valve is recommended at the discharge of the pump to prevent system fluid from flowing back through the pump during tube replacement or if the tube should rupture.
- A pressure relief valve is recommended at the discharge of the pump to prevent premature wear and damage to the pump tube in the event the discharge line becomes blocked.
- The Flex-Pro does not require back pressure. Pressure regulator valves are not required. Keep the discharge pressure as low as possible to maximize tube life.
- An anti-syphon valve is not required. Syphoning cannot occur.

2.2 Dimensions

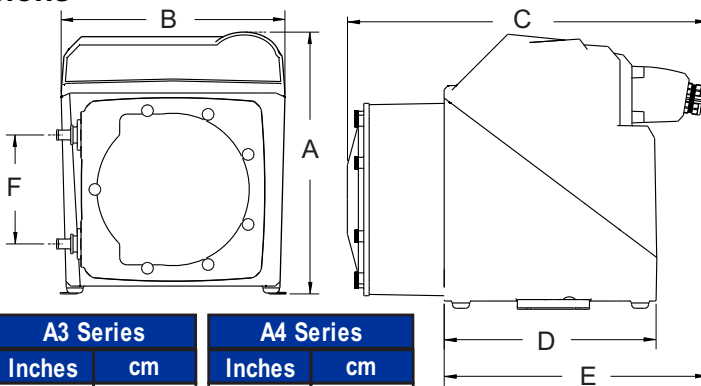

Dim	A3 Series		A4 Series	
	Inches	cm	Inches	cm
A	10-3/4"	27.3	14-1/4"	36.1
B	8-1/8"	20.6	12-1/8"	30.8
C	15-1/4"	38.9	18-5/8"	47.3
D	10"	25.4	11"	27.9
E	12-1/4"	31.0	13-5/8"	34.6
F	4-1/4"	10.7	6"	15.2

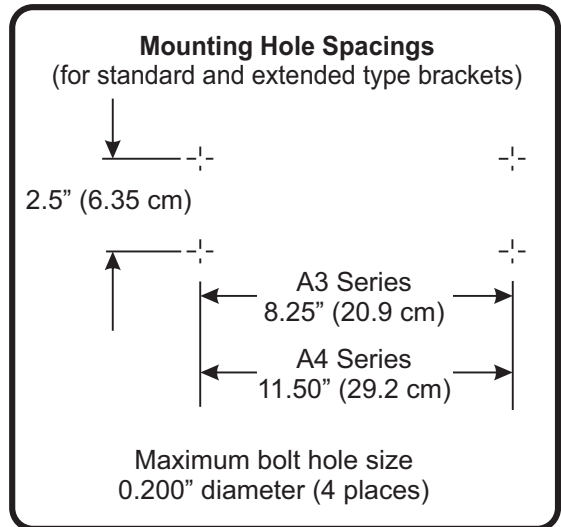

Optional Extended Brackets

Model Number 72000-380

Stainless Steel extended brackets allow pump to be securely mounted to most any surface; floor, shelf, or skid. Brackets lift pump up 4-1/2 inches (11.43 cm), for easy pump access in hard to reach areas.

- Raise metering pump 4-1/2 inches (11.43 cm) off ground or a surface.
- Made out of tough Stainless Steel.
- Provides a stable mounting surface.

Model #	Description
72000-380	Extended Mounting Bracket, 1 Pair, SS, 4 SS Screws



2.3 Installing Discharge Injection Fitting and Suction Strainer

CAUTION Proper eye and skin protection must be worn when installing and servicing pump.

CAUTION This Pump Has Been Evaluated for Use with Water Only.

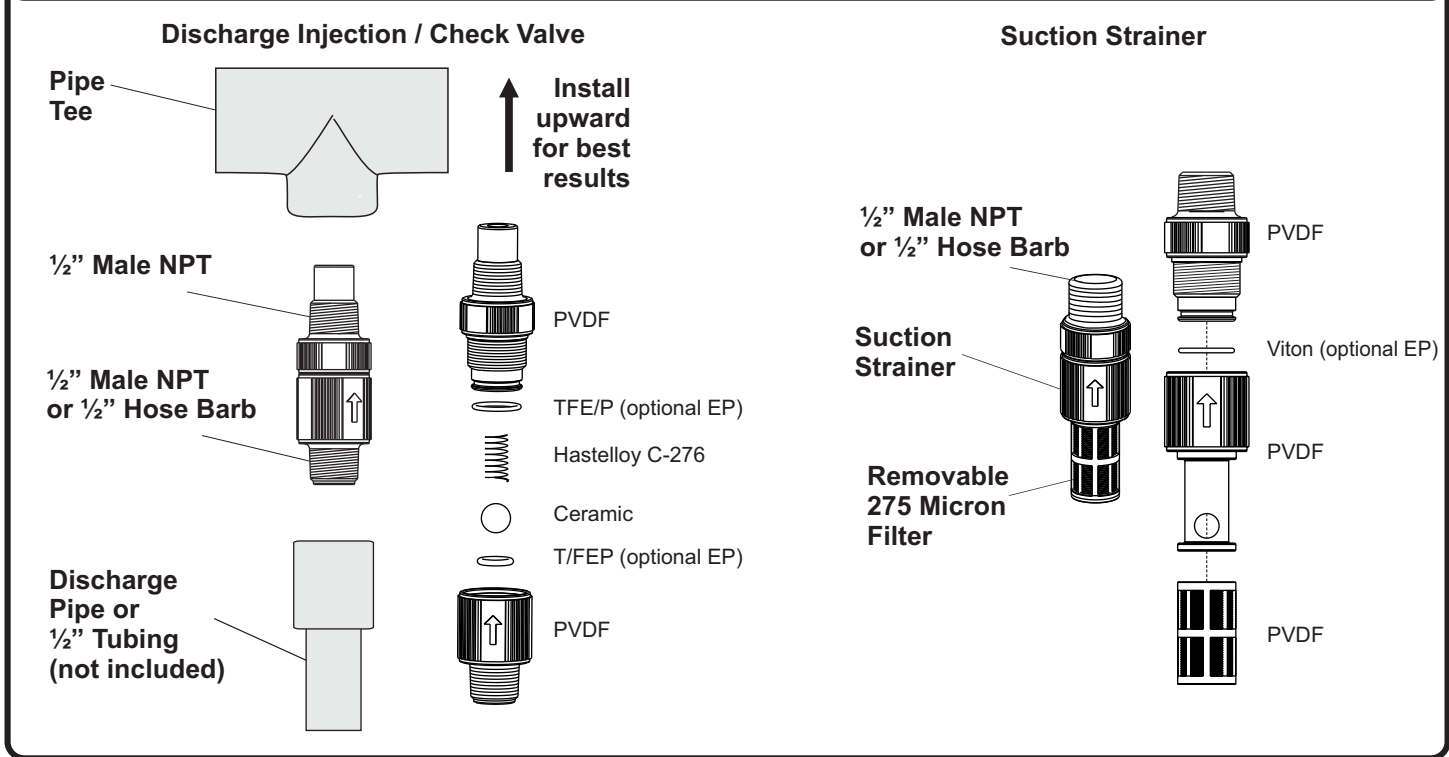

1/2" Male NPT Connection and 1/2" Hose Barb Models

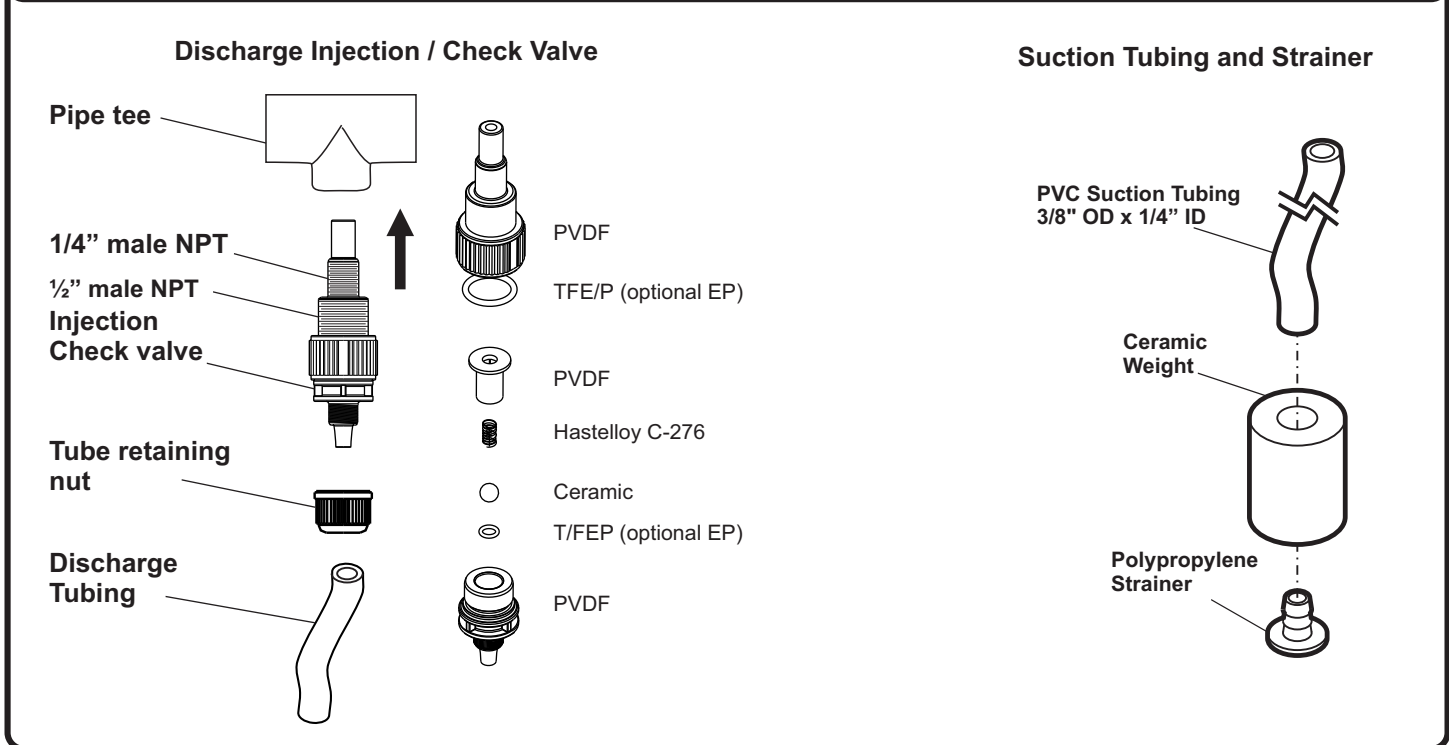

3/8" OD x 1/4" ID Tubing and Connection End Models (not included)



2.4 Input Power Connections

WARNING 	Risk of electric shock – cord connected models are supplied with a grounding conductor and grounding-type attachment plug. To reduce risk of electric shock, be certain that it is connected only to a properly grounded, grounding-type receptacle.
WARNING 	Electrical connections and grounding (earthing) must conform to local wiring codes. Be certain that a grounding conductor is connected to terminal T11-1 located in the wiring compartment.
WARNING 	Risk of electric shock - Disconnect electricity before removing the wiring compartment cover.

- Be certain to connect pump to proper supply voltage. Using incorrect voltage will damage pump and may result in injury. Voltage requirement is printed on pump serial label.
- Input power range is 96VAC to 264VAC 50/60 Hz.
- Voltage Selection is automatically detected and adjusted by power supply. No mechanical switch necessary.
- Use voltage your power cord is rated for.
- Cord connected models are supplied with a ground wire conductor and a grounding type attachment plug (power cord). To reduce risk of electric shock, be certain that power cord is connected only to a properly grounded, grounding type receptacle.
- Permanently connected models must be properly grounded. Be certain that a grounding conductor is connected to terminal T11-1 located in the wiring compartment.
- Never strap control (input / output) cables and power cables together.
- **Power Interruption:** This pump has an auto-restart feature which will restore pump to operating state it was in when power was lost.

Note: When in doubt regarding your electrical installation, contact a licensed electrician.

WIRING COMPARTMENT COVER

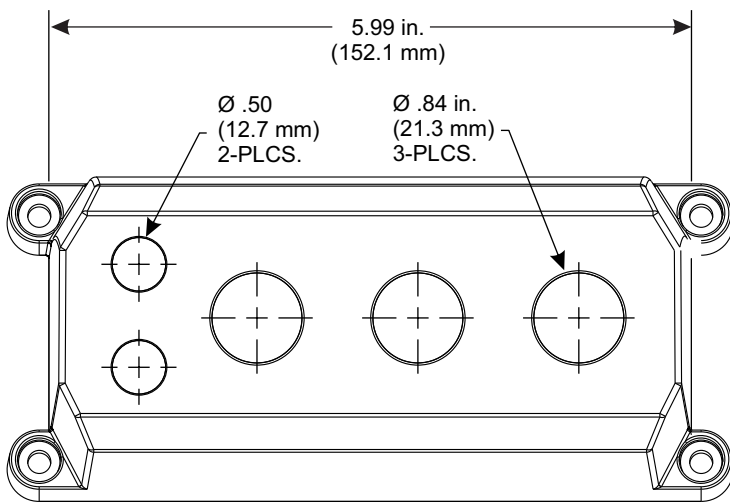

POWER CORD OPTIONS

Three power cord plug types available.
Power cord length is 6 feet (3.83 meters)



115V 60Hz NEMA 5/15 (USA) max: 125V AC	230V 60Hz NEMA 6/15 (USA) max: 250V AC	240V 50Hz CEE 7/VII (EU) max: 250V AC
--	--	---

Cable and conduit connectors included

QTY. DESCRIPTION

- 2 .50 INCH (12.7 mm) LIQ-TIGHT HOLE PLUGS (MAT'L = NEOPRENE), PRE-INSTALLED
- 3 .875 INCH (22.2 mm) LIQ-TIGHT HOLE PLUGS (MAT'L = NEOPRENE), 2 PRE-INSTALLED
- 2 .50 INCH (12.7 mm) LIQ-TIGHT CONNECTORS FOR PASS THRU CORDS (MAT'L = NYLON)
ACCEPTABLE CABLE DIAMETER .118 TO .255 INCH (3.0 TO 6.5 MM), NOT INSTALLED
- 3 .875 INCH (22.2 mm) METALLIC LIQ-TIGHT CONNECTORS FOR PASS THRU CORDS (MAT'L = NYLON)
ACCEPTABLE CABLE DIAMETER .200 TO .395 INCH (5.1 TO =10.0 MM), 1 PRE-INSTALLED WITH POWER CORD MODELS
- 2 METALLIC LIQ-TIGHT CONNECTORS FOR .50 INCH FLEXIBLE CONDUIT (MAT'L = DIE CAST ZINC), NOT INSTALLED

2.5 Wiring Terminals and I/O Schematics

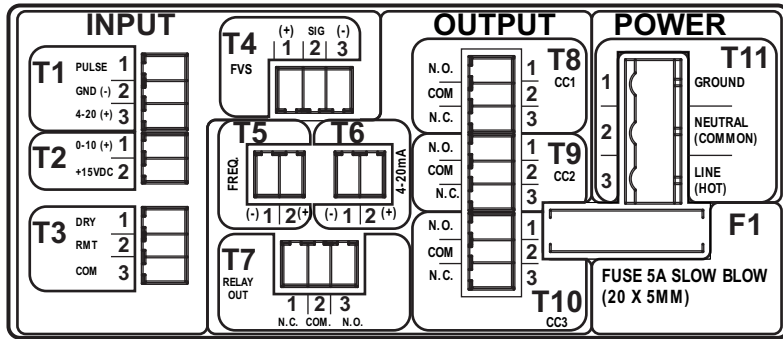

Risk of electric shock - All wiring must be insulated and rated 300V minimum.

Terminals T1 thru T10
Plug type
16 - 24 AWG



Power Input
Terminal T11
Plug type
14 - 30 AWG

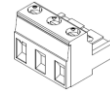

Terminal Block	Replacement #
2 Positions	90010-304
3 Positions	90010-305
5 Positions	90010-306

Shielded cables should be used on all input signal wires.

FUNCTION	TERMINAL	PIN #	RATING	ELECTRICAL SP.	BLOCK DIAGRAM
INPUT: 4-20 mA	T1	3	(+) POSITIVE	120 OHM IMPEDANCE, NON POWERED LOOP	
	T1	2	(-) NEGATIVE		
INPUT: FREQUENCY, AC SINE WAVE, TTL, CMOS	T1	1	(+) POSITIVE	0-1000 HZ MAX.	
	T1	2	(-) NEGATIVE		
INPUT: 0-10V DC	T2	1	(+) POSITIVE		
	T1	2	(-) NEGATIVE		
INPUT: FVS SYSTEM (FLOW VERIFICATION SENSOR) FV SENSOR ONLY	T4	1	(+) POSITIVE		
	T4	2	SIGNAL		
	T4	3	(-) NEGATIVE		
INPUT: FVS SYSTEM (FLOW VERIFICATION SENSOR) FS or FP MICRO-FLO FLOWMETER ONLY	T4	1	(+) POSITIVE		
	T4	2	SIGNAL		
	T4	3	(-) NEGATIVE		
INPUT: REMOTE START / STOP (DRY CONTACT C.)	T3	1	(-) NEGATIVE	NO VOLTAGE	
	T3	2	(+) POSITIVE		
INPUT: REMOTE START / STOP (WET CONTACT C.)	T3	2	(+) POSITIVE	6 TO 30 VOLT DC 1 AMP MAX.	
	T3	3	(-) NEGATIVE		
OUTPUT: 4-20 mA	T6	2	(+) POSITIVE	120 OHM RESISTANCE ACTIVE LOOP	
	T6	1	(-) NEGATIVE		
OUTPUT: FREQUENCY - OPEN COLLECTOR	T5	2	(+) POSITIVE	OPEN COLLECTOR 0-1000 Hz 50% DUTY CYCLE	
	T5	1	(-) NEGATIVE		
OUTPUT: RELAY, 6 AMP	T7	1	NORM. CLOSED	Form C 6 AMP MAX AT 250 VAC, 5 AMP MAX AT 30 VOLT DC	
	T7	2	COMMON		
	T7	3	NORM. OPEN		
OUTPUT: CONTACT CLOSURE 1	T8	1	NORM. OPEN	Form C 1 AMP MAX AT 125 VOLT AC, 0.8 AMP MAX AT 30 VOLT DC	
	T8	2	COMMON		
	T8	3	NORM. CLOSED		
OUTPUT: CONTACT CLOSURE 2	T9	1	NORM. OPEN	Form C 1 AMP MAX AT 125 VOLT AC, 0.8 AMP MAX AT 30 VOLT DC	
	T9	2	COMMON		
	T9	3	NORM. CLOSED		
OUTPUT: CONTACT CLOSURE 3	T10	1	NORM. OPEN	Form C 1 AMP MAX AT 125 VOLT AC, 0.8 AMP MAX AT 30 VOLT DC	
	T10	2	COMMON		
	T10	3	NORM. CLOSED		
INPUT: POWER	T11	1	GROUND	96 TO 264 VOLT AC, 50 / 60 HZ A3 = 220W A4 = 350W	
	T11	2	NEUTRAL		
	T11	3	LINE (HOT)		
FUSE	F1	NA	5 AMP	5A SLOW BLOW (20 X 5MM)	

NOTE: USE ONLY DRY CONTACT FOR REMOTE S/S WHEN USING 4-20mA INPUT OR 0-10V DC

3.0 How To Operate Flex-Pro

Flex-Pro V Series, Control Panel - Button Operation

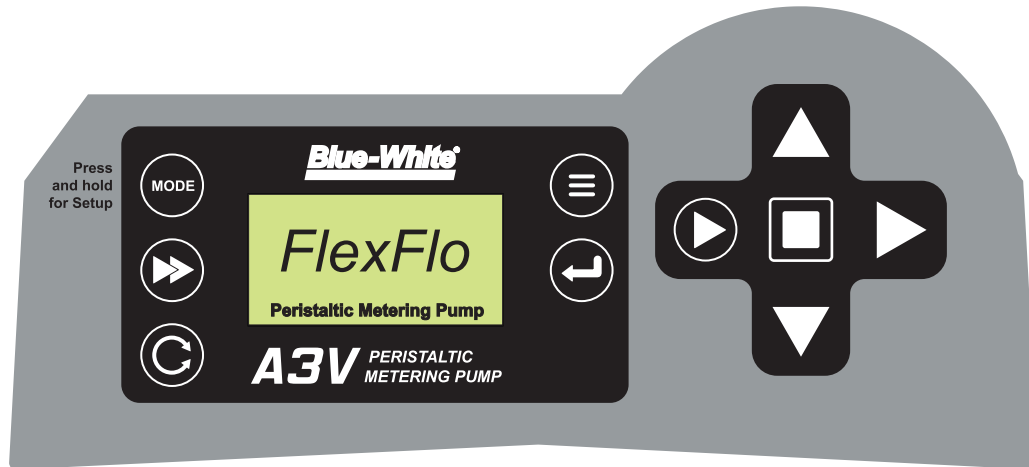

Press and hold for Setup

Press and release to select a Run Mode.
Press and hold to enter the configuration menu for the currently active run mode only.

Press and release to prime the pump.

Press and release to change the roller rotation.



Press and release to enter the configuration menus.

Press and release to confirm a menu selection.

Press and release to select menu items, increase menu values by one, and increase pump output in *Manual Speed Adjust* mode.
Press and hold to increase values progressively faster.

Press and release to start the pump.

Press and release to stop the pump.

Press and release to select menu items, decrease menu values by one, and decrease pump output in *Manual Speed Adjust* mode.
Press and hold to decrease values progressively faster.

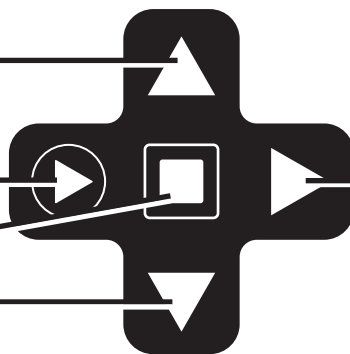

Press and release to select menu items.
Press and release (when not in the configuration menu) to toggle the display units of measure and to display the current input signal values

DOWN Arrow + ENTER

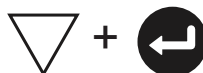

Flex-Pro has a built in Pump Tube Timer. Timer starts when rotor is rotating and stops when rotor is idle. To view current Pump Tube Timer value, press ENTER and DOWN arrow at same time while in the normal operating mode. Screen will display current Pump Tube Time in run-time hours. While displayed, press ENTER button twice to reset Pump Tube Timer to zero.

3.1 Menu Navigation

- Sample screen shots -

Use MENU button to enter menu for setting up pump.

Use UP or DOWN arrows to navigate through menu.

Active option appears on pump display in **inverse** text.

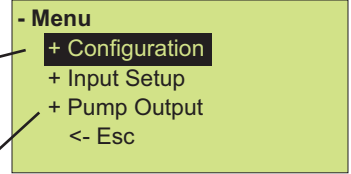

Plus symbol + signifies top of a menu tree. This means you can go further within menu.

Within Menu of pump, each screen you enter will have a title located along top. This will display the menu that is currently active, or this will be the setting you are configuring.

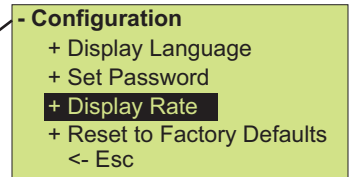

To back out of menu, select <- Esc line located at end of list. Then press ENTER button. This will take you back one level.

When menu list extends above or below height of display, a scroll bar will appear on left side. Press DOWN arrow to scroll down to end of list to see a list of all available options.

Scroll bar example:

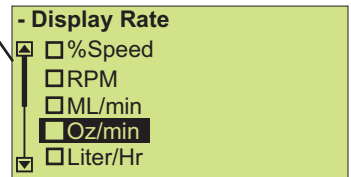

While making a selection where only one choice is allowed, you will see a radio button.

Radio button example: Solid black means item is selected
 Outline with no fill means item is not selected

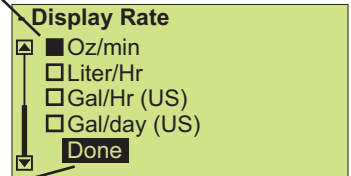

In a screen where you are making changes, you will see the word **Done** located at bottom of list. You must select **Done** in order to leave screen (whether you made a change or not). Selecting **Done** will take you back to parent level.

When inputting a numerical value, use UP or DOWN arrow to scroll through 0 - 9. To move over to next digit use RIGHT arrow. If you pass your desired digit, you can continuously press RIGHT arrow until you scroll reach to your desired digit.

Numeric value example: **0000**

Tip!

Removing the pump head cover automatically puts the pump into "maintenance" mode, allowing the operator to replace the pump tube without changing the Remote/Local settings.

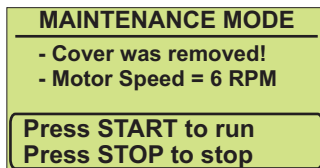
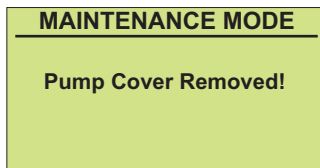

3.2.2 Display Rate (Units of Measure)

By default, pump will display %Speed (motor speed) and RPM. It is recommended you select an additional **Display Rate**. After selecting another **Display Rate** (such as ML/Min), pump will still display %Speed and RPM along with your selected Display Rate.

Press MENU button to enter menu structure for setting up pump.

Select **Configuration** and Press ENTER button.

Select **Display Rate** and Press ENTER button.

Select your desired Display Rate (unit of measure). Note: %Speed and RPM will always be active and available to view when pump is in operation.

Select **Done** at bottom of list to confirm your selection and to return back to previous screen. Press ENTER button.

Select **<-Esc** on following screens to move back up to desired menu location.

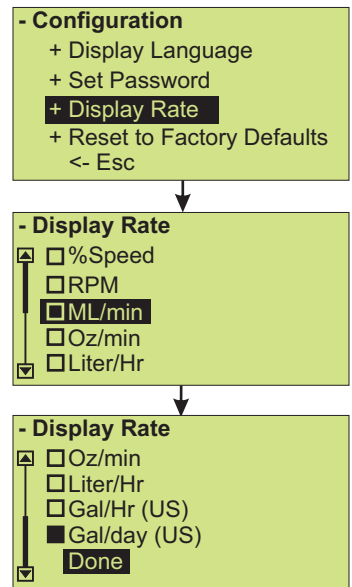

Tip! 

While pump is operating in any Run Mode, you can view %Speed, RPM, plus another Display Rate (depending on your selection above). Press RIGHT arrow while pump is in any Run Mode. RIGHT arrow is a convenient way to scroll through multiple read-only screens during normal operating mode of pump.

Note: This is a read-only feature, no changes can be made while in Run Mode.

3.2.3 Reset Factory Defaults

This will reset pump to factory defaults. This will restore pump to original configuration when it left the factory.

Press MENU button to enter menu structure for setting up pump.

Select **Configuration** and Press ENTER button.

Select **Reset to Factory Defaults** and Press ENTER button.

Select **No** or **Yes**, then ENTER button.

Select **<-Esc** on the following screens to move back up to desired menu location.

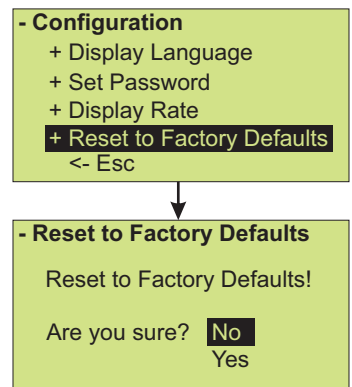

3.2 Configuration Menu

Below is menu structure for Configuration screens.

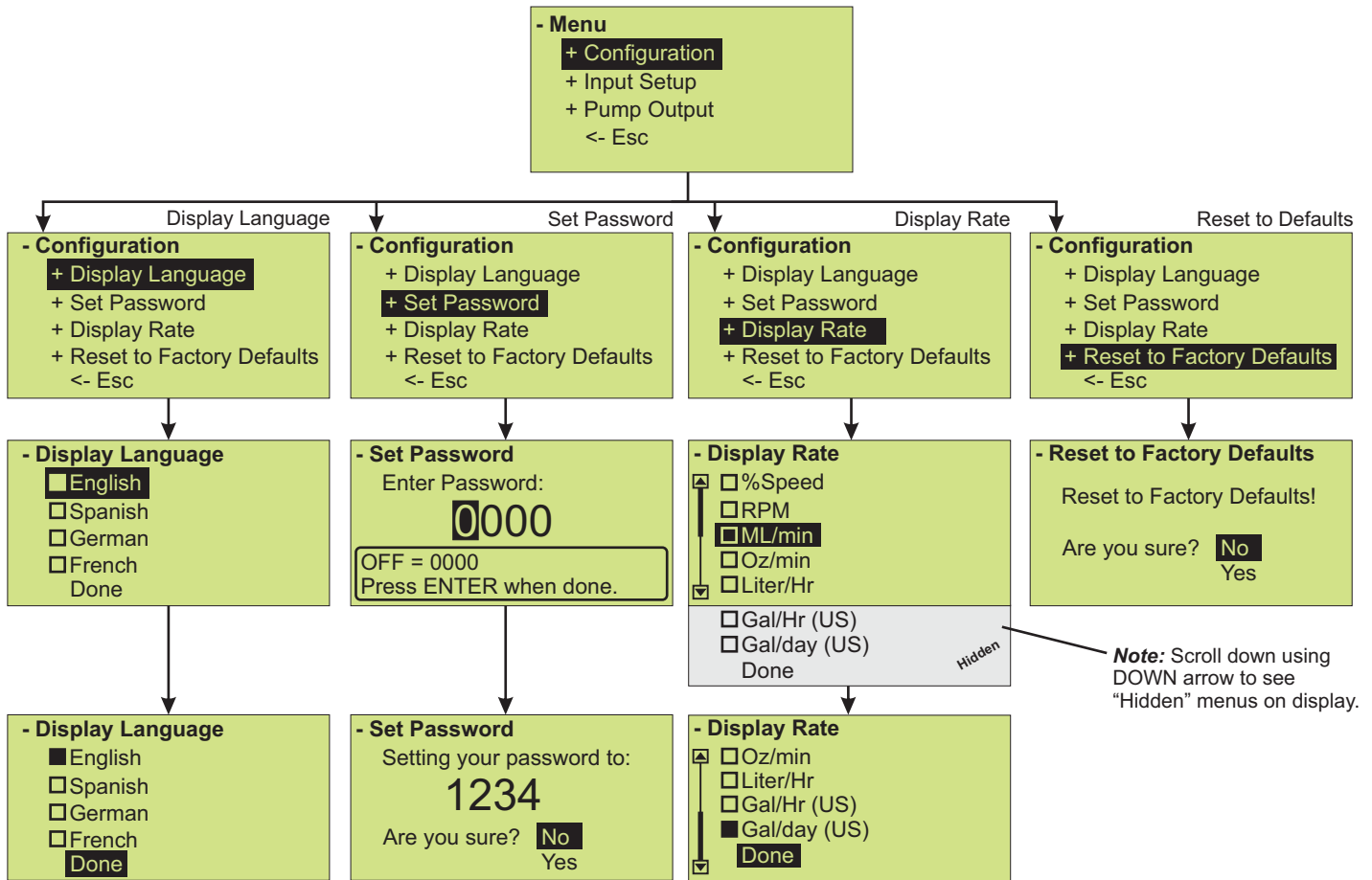

Note: Scroll down using DOWN arrow to see "Hidden" menus on display.

3.2.1 Language Selection

Press MENU button to enter menu structure for setting up pump.

Select **Configuration** and Press ENTER button.

Select **Display Language** and Press ENTER button.

Select your desired language, then Press ENTER.

Note: English is default language.

Select **Done** at bottom of list to confirm your selection. Press ENTER button.

Select **<-Esc** on following screens to move back up to desired menu location.

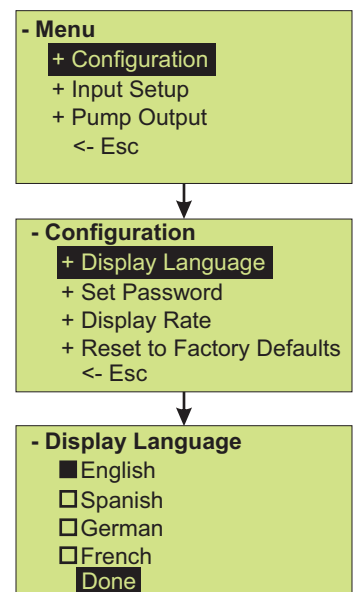

4.0 Input Setup

Below is the menu structure for the INPUT SETUP selection.

Max RPM cut-off - 4.1

To Select a maximum motor RPM. Input the maximum RPM value.

Max Flowrate - 4.2

To calibrate your pump. This setting is pre-configured at the factory based on the tube size supplied when ordered. Pump has been calibrated with water. You can re-calibrate pump. Input the calibrated ml/min at 100% motor speed.

Input Modes - 4.3

To configure your pump's Run Modes. Use this menu to setup your desired operating mode. This manual will cover each step in detail later.

Contact Input - 4.4

(remote start/stop)
Contact Closure Input feature is used to Start and Stop pump remotely. Default setting is DISABLE.

Set FVS - 4.5

(Flow Verification System)
Set Flow Verification time delay. Use this feature if you are using a Blue-White flow verification sensor to monitor flow output. Default setting is OFF.

Set TFD - 4.6

(Tube Failure Detection)
Set Tube Failure Detection sensitivity. Use this feature to increase the sensitivity to your chemical. Default setting is 75%.

Set Remote/Local control - 4.7

(Control panel touch pad lockout)
Select remote to disable the touch pad buttons enabling input signal control only. When remote is selected, the user must select an input operating mode. Select Local to disable all input signals and allow local touch pad control only.

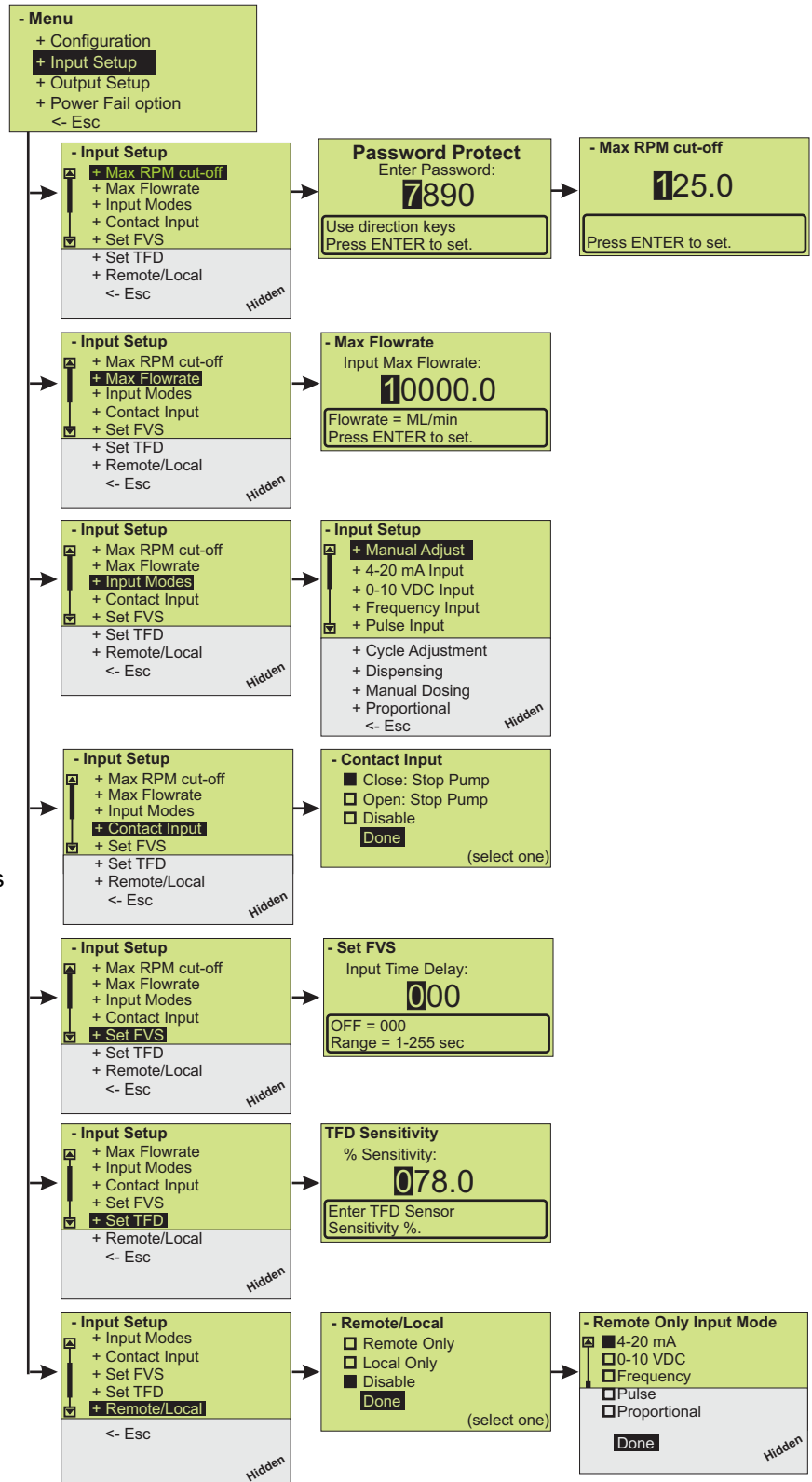

4.1 Max RPM cut-off

The maximum motor RPM can be limited to reduce the possibility of overfeeding chemical into the system. Note that the pump's display will still reference values calculated from the 100% motor speed MAX Flowrate value (see section 4.2). Also, the pump % motor speed will still be referenced from 125 RPM, the maximum possible motor RPM. For example, if the pump speed is set for 25%, the display will indicate 32.3 RPM. The prime mode RPM is limited to the Max RPM value.

Select **Max RPM cut-off** and Press ENTER button. Use the direction arrows to enter the password 7890.

Press UP or DOWN arrow to scroll through 0 - 9 on selected digit.

Press RIGHT arrow to scroll over to next digit to right. If you pass your desired digit, you can easily scroll back by continuously pressing RIGHT button.

Press ENTER to save changes.

Select **<-Esc** on the main menu screen to exit the menu and enter the run mode.

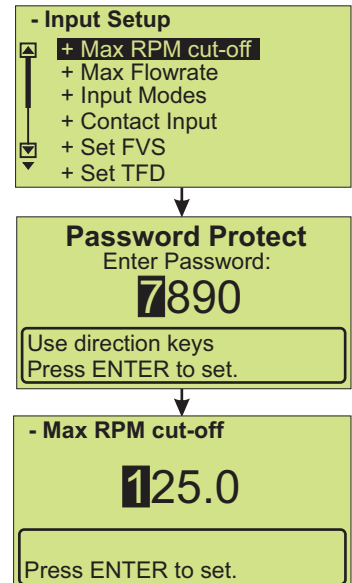

4.2 MAX Flowrate (output calibration)

The MAX Flowrate value is equal to the pump's measured fluid output in milliliters per minute, at the 100% motor speed adjustment setting. The pump uses the MAX flow rate value to calculate motor speed for various operating functions and to display output values.

Each Flex-Pro pump is calibrated at the factory and shipped with a calibrated pump tube assembly installed. The MAX flow rate value can be adjusted at any time. To achieve high accuracy, a field calibration under the actual operating conditions should be performed and the Max Flowrate value changed to reflect the calibrated amount. Multiply the **Max Flowrate** value by the percentage of error at your calibrated flow rate to obtain the new **Max Flowrate** value.

Select **Max Flowrate** and Press ENTER button.

Press UP or DOWN arrow to scroll through 0 - 9 on selected digit.

Press RIGHT arrow to scroll over to next digit to right. If you pass your desired digit, you can easily scroll back by continuously pressing RIGHT button.

Press ENTER to save changes.

Select **<-Esc** on the main menu screen to exit the menu structure and enter the run mode.

Every pump tube assembly model number has a published maximum flow rate value which is based on laboratory tests pumping water at room temperature at 36" suction lift against 0 psi back pressure. Your actual output may vary due to fluid viscosity, fluid temperature, suction lift height, piping system layout, manufacturing tolerances and to a lesser degree, variations in system pressure and tubing wear.

To achieve high accuracy, the pump's output should be measured (calibrated), and the MAX Flowrate value (in milliliters per minute) updated, whenever any of the following conditions exist:

- At the initial pump start up.
- When a new tube assembly is installed. *Run the pump with or without fluid for approximately 30 minutes prior to calibration.*
- When the piping system configuration is changed.
- When the suction lift height is changed.
- Periodically during the life of the tube. *Output variances are most noticeable prior to tube failure.*

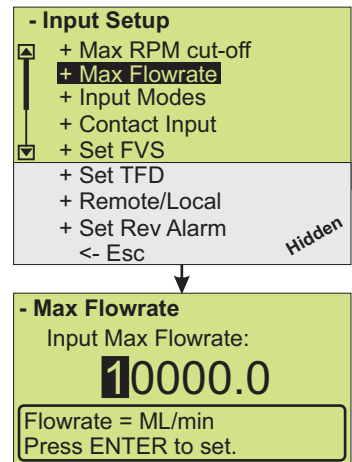

To calculate the Max Flowrate:

To determine the amount of error at your output setting, divide the actual output amount by the indicated output. Then multiply the resulting percentage of error by the **Max Flowrate** value currently showing in the pump.

Example: If the pump display indicates the output is 170 ml/min but the actual measured output is 160 ml/min, calculate the percentage of error by: $160/170 = 0.941$. Multiply the **Max Flowrate** value by 0.941 and enter this new value.

4.3 Input Setup (operating mode configuration)

Tip!  Press and hold to enter Mode Setup

SELECT RUN MODE button also serves as a shortcut button. **Press and Hold** SELECT RUN MODE button to enter program menu for currently displayed Run Mode. Once you have programed your Run Mode, Press ENTER to save changes. **Press and Hold** SELECT RUN MODE button to jump back to current Run Mode of the pump. Then **Press** START button to start pump with new settings applied.

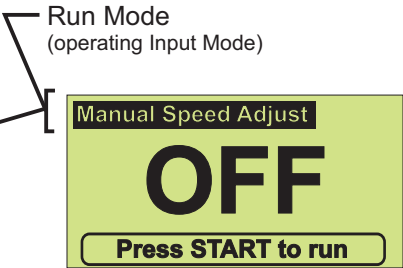

4.3.1 Manual Adjust (manual speed adjust)

Used to manually control speed of pump. Use up and down arrows to adjust the speed while the pump is running or set % (percent) Motor Speed in this menu.

Press SELECT RUN MODE button until **Manual Speed Adjust** is displayed in the top line of the display.

To configure the pump output speed, navigate to **Manual Speed Adjust** menu by using short-cut method described above, or by pressing MENU button, then selecting Input Setup, Input Modes, and then **Manual Adjust**.

Press UP or DOWN arrow to scroll through 0 - 9 on selected digit.

Press RIGHT arrow to scroll over to next digit to right. If you pass your desired digit, you can easily scroll back by continuously pressing RIGHT button.

Press ENTER to save changes.

If you used short-cut to enter Manual Speed Adjust setup, then just press and hold Select Run Mode button until Run Mode screen is displayed.

If you used Menu button to navigate to Manual Speed Adjust setup, you must navigate back out of menu structure. To do this you must select <-Esc at bottom of every screen menu until you see Run Mode screen displayed.

Tip! This feature can be combined with **Contact Input** feature to allow for remote Start and Stop of pump. Can be used with PLC, foot pedal, push button, or other external controls.

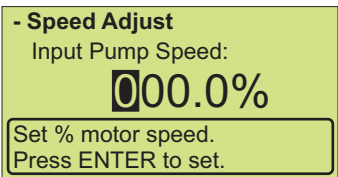

Tip! 

In Manual Speed Adjust mode, you can view pump output by pressing RIGHT arrow (see screen shot). RIGHT arrow is a convenient way to scroll through multiple read-only screens during normal operating mode of pump.

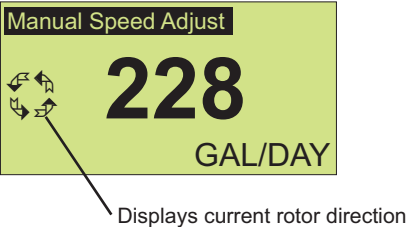

4.3.2 4 - 20 mA Input

Used to remotely control pump with an incoming 4-20 mA signal.

Default settings: 4 mA = 0% motor speed
20 mA = 100% motor speed

Press SELECT RUN MODE button until **4 - 20 mA Input** is displayed in the top line of the display.

To configure the pump, navigate to **4 - 20 mA Input** menu by using short-cut method described at beginning of section, or by pressing MENU button, then selecting Input Setup, Input Modes, and then **2 - 20 mA Input**.

Press UP or DOWN arrow to scroll through 0 - 9 on selected digit.

Press RIGHT arrow to scroll over to next digit to right. If you pass your desired digit, you can easily scroll back by continuously pressing RIGHT button.

Press ENTER to save changes.

Continue this process until all four screens have been configured.

If you used short-cut to enter 4-20 mA input setup, then just press and hold Select Run Mode button until Run Mode screen is displayed.

If you used Menu button to navigate to 4-20 mA input setup, you must navigate back out of menu structure. To do this you must select <-Esc at bottom of every screen menu until you see Run Mode screen displayed.

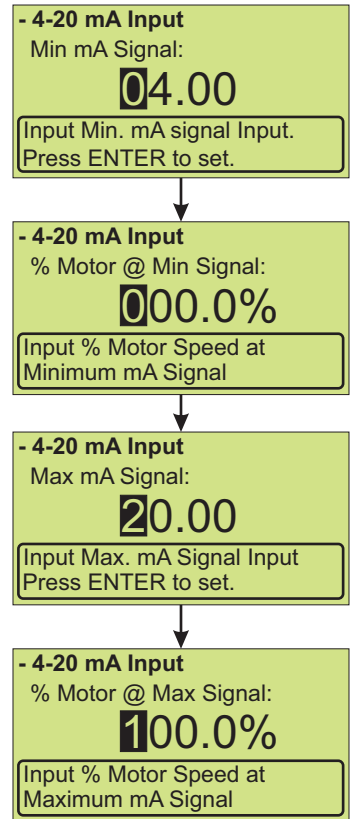

Example 1

4 mA = 0% Pump Output
20 mA = 100% Pump Output

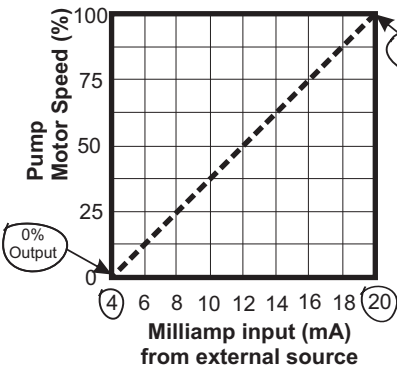

Example 2

4 mA = 100% Pump Output
20 mA = 0% Pump Output

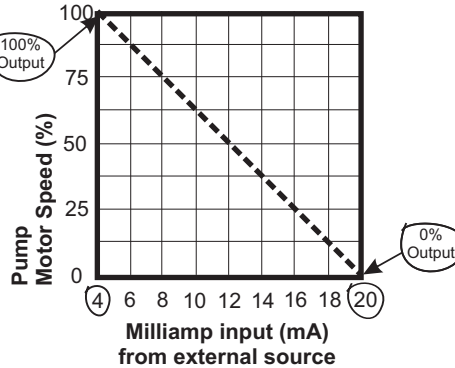

Example 3

4 mA = 20% Pump Output
16 mA = 43.8% Pump Output

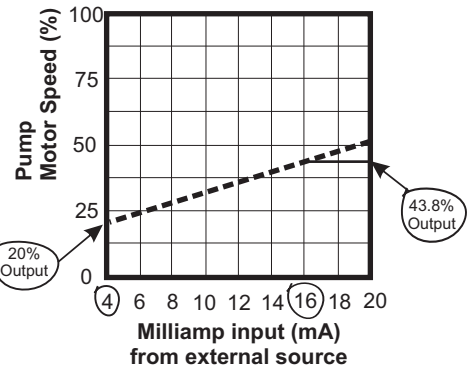

Tip!



In 4 - 20 mA mode, you can view current incoming signal by pressing RIGHT arrow (see screen shot). RIGHT arrow is a convenient way to scroll through multiple read-only screens during normal operating mode of pump.

- Screen Shot -

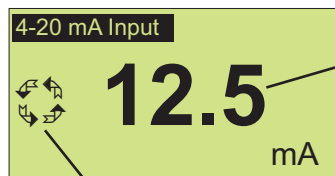

Displays current incoming signal

Displays current rotor direction

4.3.3 0 - 10 VDC Input (Volt DC)

Used to remotely control pump with an incoming 0-10 VDC signal.

Default settings: 0 VDC = 0% motor speed
10 VDC = 100% motor speed

Press SELECT RUN MODE button until **0 - 10 VDC Input** is displayed in the top line of the display.

To configure the pump, navigate to **0 - 10 VDC Input** menu by using short-cut method described at beginning of section, or by pressing MENU button, then selecting Input Setup, Input Modes, and then **0 - 10 VDC Input**.

Press UP or DOWN arrow to scroll through 0 - 9 on selected digit.

Press RIGHT arrow to scroll over to next digit to right. If you pass your desired digit, you can easily scroll back by continuously pressing RIGHT button.

Press ENTER to save changes.

Continue this process until all four screens have been configured.

If you used short-cut to enter 0 - 10 VDC Input setup, then just press and hold Select Run Mode button until Run Mode screen is displayed.

If you used Menu button to navigate to 0 - 10 VDC Input setup, you must navigate back out of menu structure. To do this you must select <-Esc at bottom of every screen menu until you see Run Mode screen displayed.

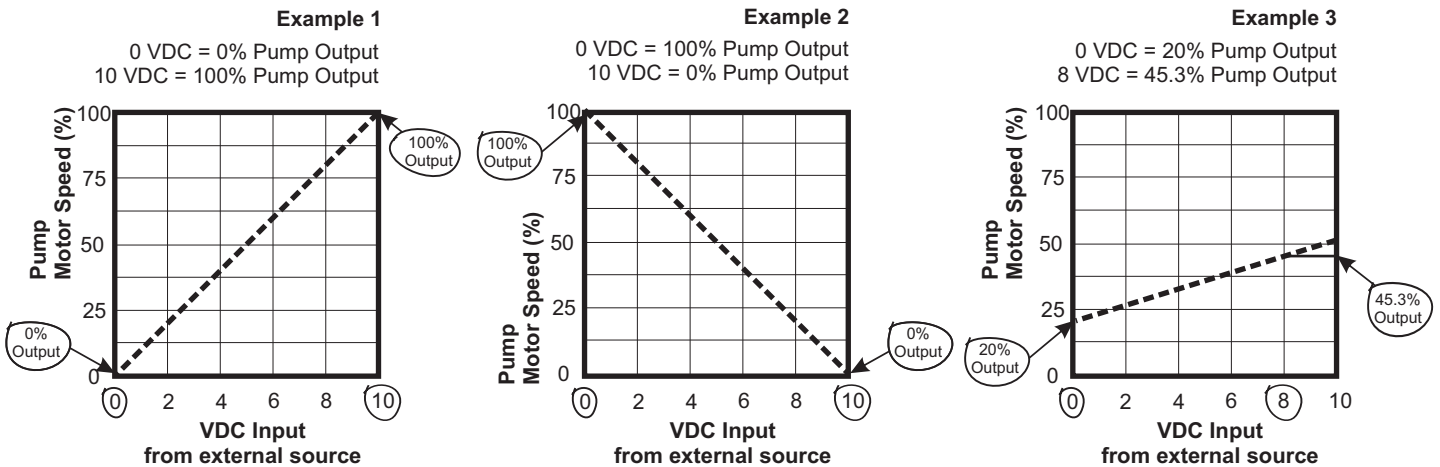
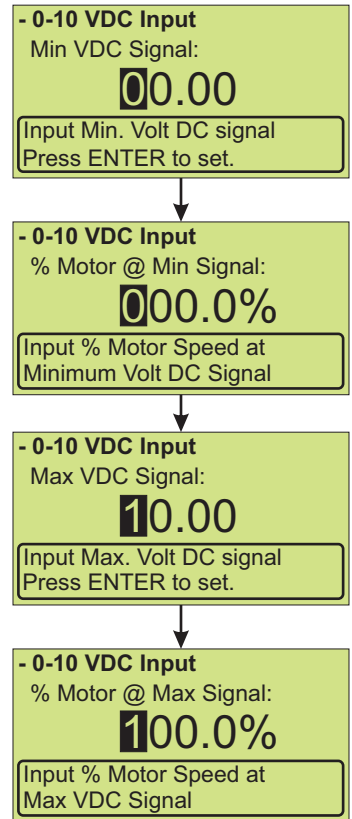

Tip! 

In 0 - 10 VDC mode, you can view current incoming signal by pressing RIGHT arrow (see screen shot). RIGHT arrow is a convenient way to scroll through multiple read-only screens during normal operating mode of pump.

- Screen Shot -

Displays current incoming signal

Displays current rotor direction

4.3.4 Frequency Input (Hz)

Used to remotely control pump with an incoming high speed frequency signal. Typically used with flow meters or other external devices.

Default settings: 0 Frequency (Hz) = 0% motor speed
1000 Frequency (Hz) = 100% motor speed

Press SELECT RUN MODE button until **Frequency Input** is displayed in the top line of the display.

To configure the pump, navigate to **Frequency Input** menu by using short-cut method described at beginning of section, or by pressing MENU button, then selecting Input Setup, Input Modes, and then **Frequency Input**.

Press UP or DOWN arrow to scroll through 0 - 9 on selected digit.

Press RIGHT arrow to scroll over to next digit to right. If you pass your desired digit, you can easily scroll back by continuously pressing RIGHT button.

Press ENTER to save changes.

Continue this process until all four screens have been configured.

If you used short-cut to enter Frequency Input setup, then just press and hold Select Run Mode button until Run Mode screen is displayed.

If you used Menu button to navigate to Frequency Input setup, you must navigate back out of menu structure. To do this you must select <-Esc at bottom of every screen menu until you see Run Mode screen displayed.

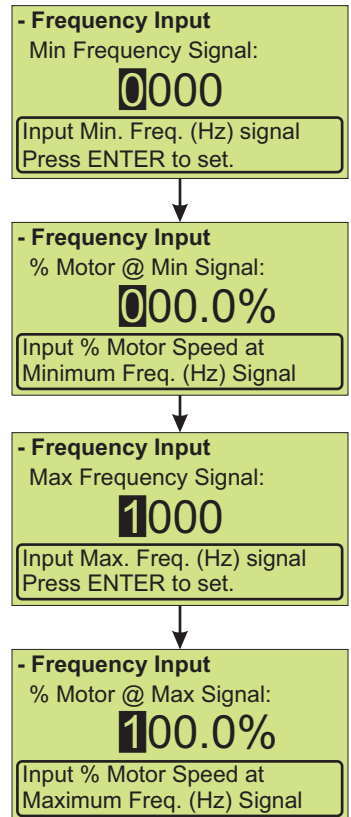

Examples:

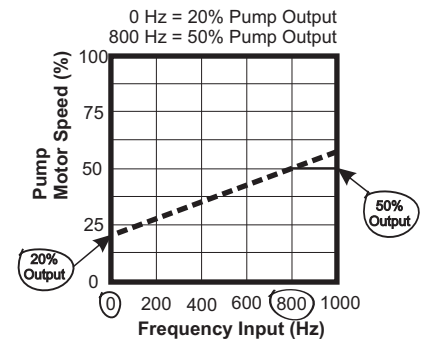
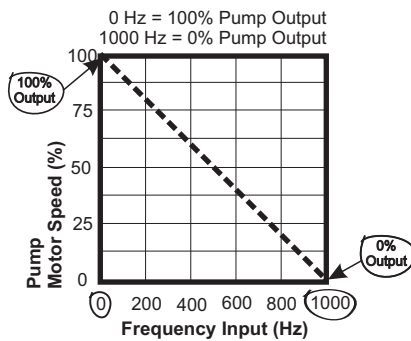
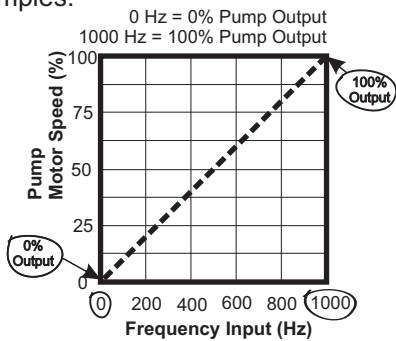

Example #1, Ultrasonic flow meter

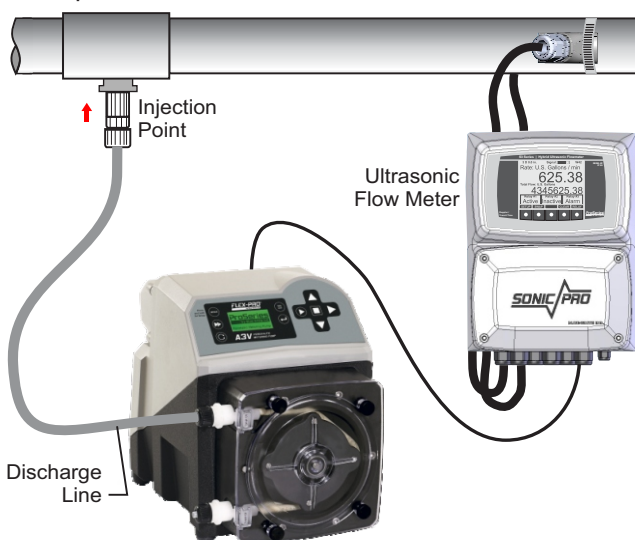

Example #2, Paddlewheel flow meter

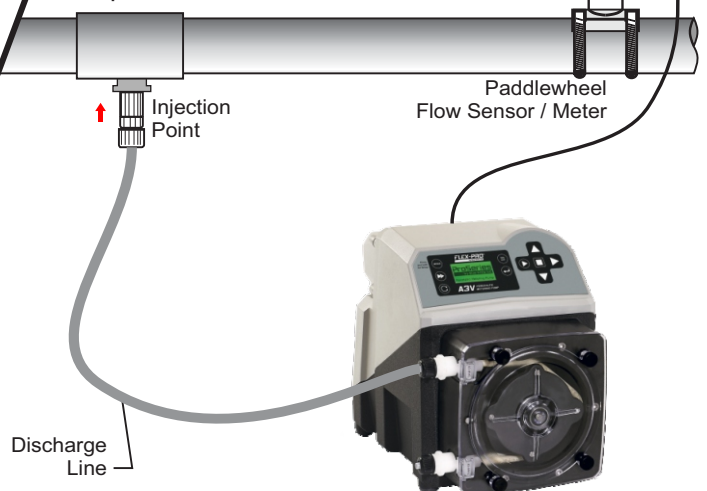

Tip! 

In Frequency Input mode, you can view current incoming signal by pressing RIGHT arrow (see screen shot). RIGHT arrow is a convenient way to scroll through multiple read-only screens during normal operating mode of pump.

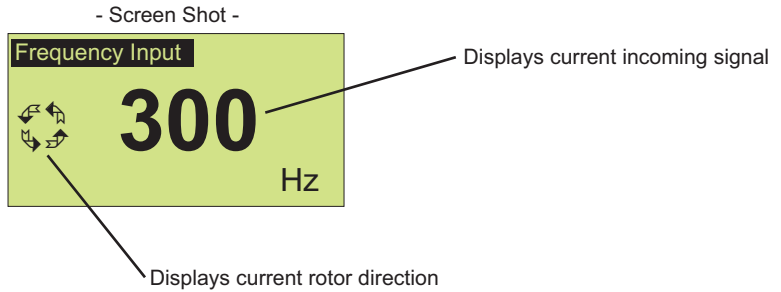

4.3.5 Pulse Batch (low speed pulse)

Used to remotely control pump with an incoming pulse signal. Can be used with an external foot pedal, a water meter, a PLC, contact closure, or other low speed pulse devices.

Default settings: 1 Pulse = 100% motor speed for 2.5 seconds

Press SELECT RUN MODE button until **Pulse Batch** is displayed in the top line of the display.

To configure the pump, navigate to **Pulse Batch** menu by using short-cut method described at beginning of section, or by pressing MENU button, then selecting Input Setup, Input Modes, and then **Pulse Batch**.

Press UP or DOWN arrow to scroll through 0 - 9 on selected digit.

Press RIGHT arrow to scroll over to next digit to right. If you pass your desired digit, you can easily scroll back by continuously pressing RIGHT button.

Press ENTER to save changes.

Continue this process until all four screens have been configured.

If you used short-cut to enter Pulse Batch setup, then just press and hold Select Run Mode button until Run Mode screen is displayed.

If you used Menu button to navigate to Pulse Batch setup, you must navigate back out of menu structure. To do this you must select <-Esc at bottom of every screen menu until you see Run Mode screen displayed.

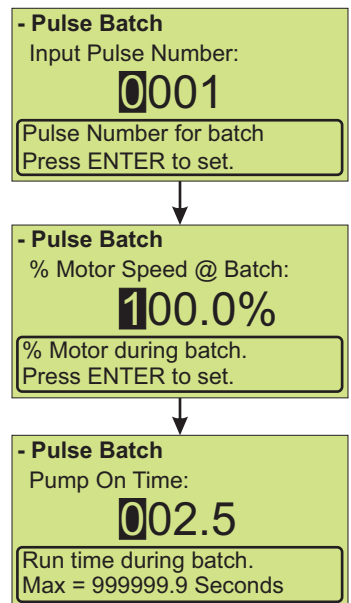

Tip! 

In Pulse Batch mode, you can view current incoming signal count by pressing RIGHT arrow (see screen shot). RIGHT arrow is a convenient way to scroll through multiple read-only screens during normal operating mode of pump.

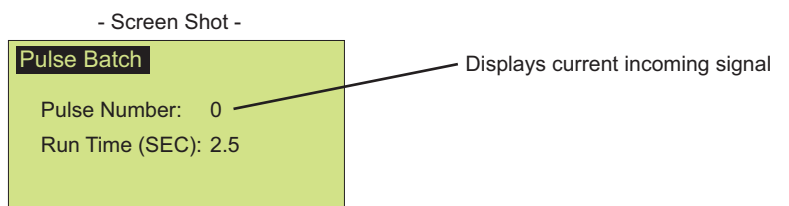

4.3.6 Manual Cycle Adjust (repeating cycle timer)

Used to run at a pre-selected motor speed for a specified run time. This cycle will repeat itself using a repeating cycle timer.

Default settings: 100% motor speed for 1.5 seconds
Repeating cycle timer = 4 seconds

Press SELECT RUN MODE button until **Manual Cycle Adjust** is displayed in the top line of the display.

To configure the pump, navigate to **Manual Cycle Adjustment** menu by using short-cut method described at beginning of section, or by pressing MENU button, then selecting Input Setup, Input Modes, and then **Cycle Adjustment**.

Press UP or DOWN arrow to scroll through 0 - 9 on selected digit.

Press RIGHT arrow to scroll over to next digit to right. If you pass your desired digit, you can easily scroll back by continuously pressing RIGHT button.

Press ENTER to save changes.

Continue this process until all three screens have been configured.

If you used short-cut to enter Manual Cycle Adjustment setup, then just press and hold Select Run Mode button until Run Mode screen is displayed.

If you used Menu button to navigate to Cycle Adjustment setup, you must navigate back out of menu structure. To do this you must select <-Esc at bottom of every screen menu until you see Run Mode screen displayed.

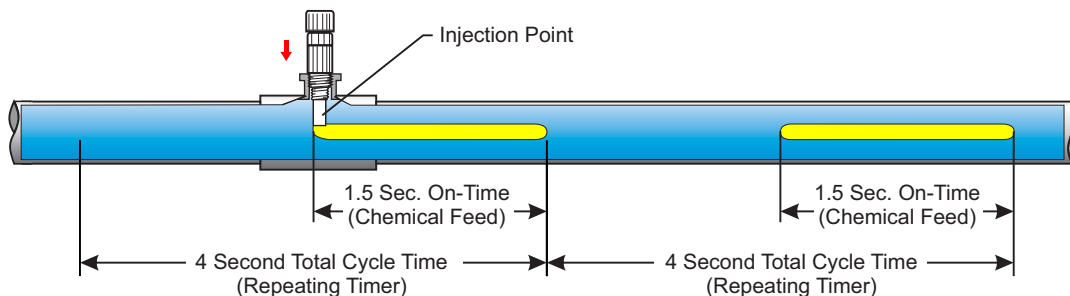
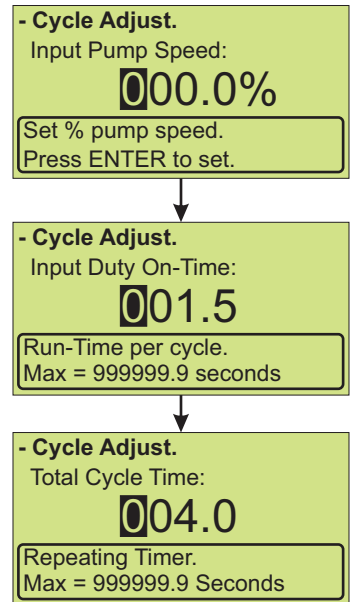

Graphical representation of Manual Cycle Adjust injection characteristics.

Note: Your chemical or solution is mixed in fluid. This image is only illustrating feed characteristics.

Tip!



In Manual Cycle Adjust mode, you can view current settings by pressing RIGHT arrow (see screen shot). RIGHT arrow is a convenient way to scroll through multiple read-only screens during normal operating mode of pump.

- Screen Shot -

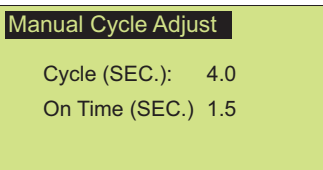

4.3.7 Dispensing

Configure any dispensing amount or sample size and pump will repeat it on command by pressing START button. Great for accurate single shot dispensing of a pre-configured volume.

Default settings: 1000 milliliters
 50% pump speed

Press SELECT RUN MODE button until **Dispensing** is displayed in the top line of the display.

To configure the pump, navigate to **Dispensing** menu by using short-cut method described at beginning of section, or by pressing MENU button, then selecting Input Setup, Input Modes, and then **Dispensing**.

Press UP or DOWN arrow to scroll through 0 - 9 on selected digit.

Press RIGHT arrow to scroll over to next digit to right. If you pass your desired digit, you can easily scroll back by continuously pressing RIGHT button.

Press ENTER to save changes.

Continue this process until all two screens have been configured.

If you used short-cut to enter Dispensing setup, then just press and hold Select Run Mode button until Run Mode screen is displayed.

If you used Menu button to navigate to Dispensing setup, you must navigate back out of menu structure. To do this you must select <-Esc at bottom of every screen menu until you see Run Mode screen displayed.

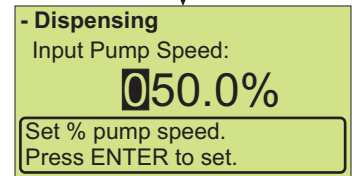
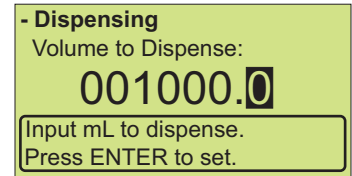

Tip!



In Dispensing mode, you can view current incoming signal count by pressing RIGHT arrow (see screen shot). RIGHT arrow is a convenient way to scroll through multiple read-only screens during normal operating mode of pump.

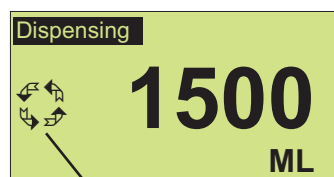

Displays current rotor direction

4.3.8 Manual Dosing

Used to configure Parts Per Million dosing to a system. This method can be used if treated fluid volume is a fixed amount (in Liters Per Minute). If treated fluid volume is variable (continuous change), then use of a flow meter is recommended along with pumps Proportional Mode (next Run Mode).

Default settings: 12.5% dose solution concentration
1.25 dose solution Specific Gravity
10 LPM (liters per minute) fluid volume to be treated
1.0 Parts Per Million to dose

Press SELECT RUN MODE button until **Manual Dosing** is displayed in the top line of the display.

To configure the pump, navigate to **Manual Dosing** menu by using short-cut method described at beginning of section, or by pressing MENU button, then selecting Input Setup, Input Modes, and then **Manual Dosing**.

Press UP or DOWN arrow to scroll through 0 - 9 on selected digit.

Press RIGHT arrow to scroll over to next digit to right. If you pass your desired digit, you can easily scroll back by continuously pressing RIGHT button.

Press ENTER to save changes.

Continue this process until all four screens have been configured.

If you used short-cut to enter Manual Dosing setup, then just press and hold Select Run Mode button until Run Mode screen is displayed.

If you used Menu button to navigate to Manual Dosing setup, you must navigate back out of menu structure. To do this you must select <-Esc at bottom of every screen menu until you see Run Mode screen displayed.

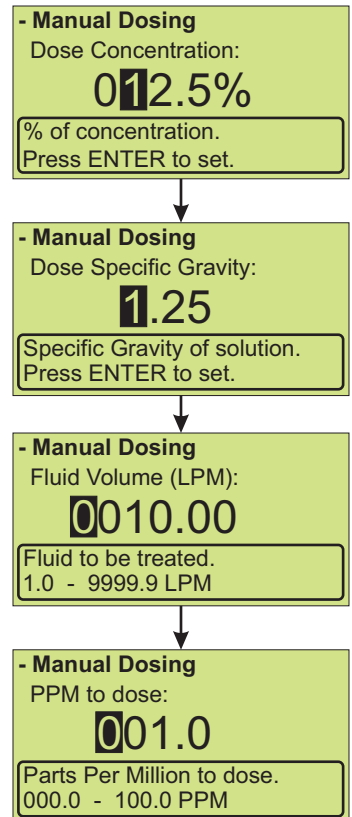

Tip! 

In Manual Dosing mode, you can view current settings by pressing RIGHT arrow (see screen shot). RIGHT arrow is a convenient way to scroll through multiple read-only screens during normal operating mode of pump.

- Screen Shot -

Manual Dosing	
% Concentration:	12.5
Spec. Gravity:	1.25

4.3.9 Proportional Dosing

Used to configure proportional Parts Per Million dosing to a system. This method of proportional dosing is based off input pump is receiving from an external flow meter. Flow meter must have a pulse output. You will need to refer to flow meter instruction manual to obtain K-factor for flow meter.

Default settings: 12.5% dose solution concentration
 1.25 dose solution Specific Gravity
 5.0 K-factor (Pulses Per Liter), see flow meter instruction manual
 1.0 Parts Per Million to dose

Press SELECT RUN MODE button until **Proportional Dosing** is displayed in the top line of the display.

To configure the pump, navigate to **Proportional Dosing** menu by using short-cut method described at beginning of section, or by pressing MENU button, then selecting Input Setup, Input Modes, and then **Proportional**.

Press UP or DOWN arrow to scroll through 0 - 9 on selected digit.

Press RIGHT arrow to scroll over to next digit to right. If you pass your desired digit, you can easily scroll back by continuously pressing RIGHT button.

Press ENTER to save the changes.

Continue this process until all four screens have been configured.

If you used short-cut to enter Proportional Dosing setup, then just press and hold Select Run Mode button until Run Mode screen is displayed.

If you used Menu button to navigate to Proportional Dosing setup, you must navigate back out of menu structure. To do this you must select <-Esc at bottom of every screen menu until you see Run Mode screen displayed.

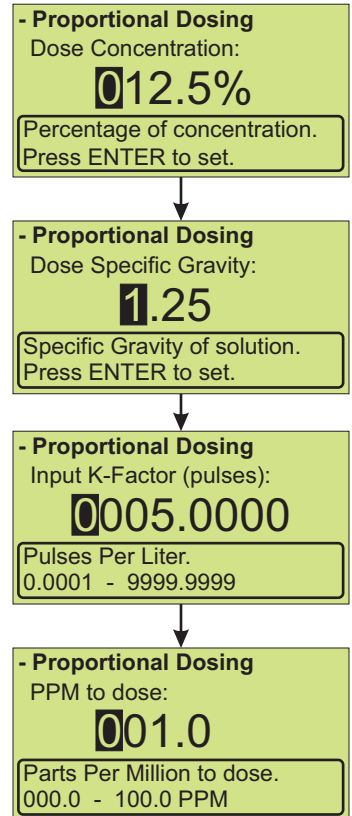

Example #1, Ultrasonic flow meter

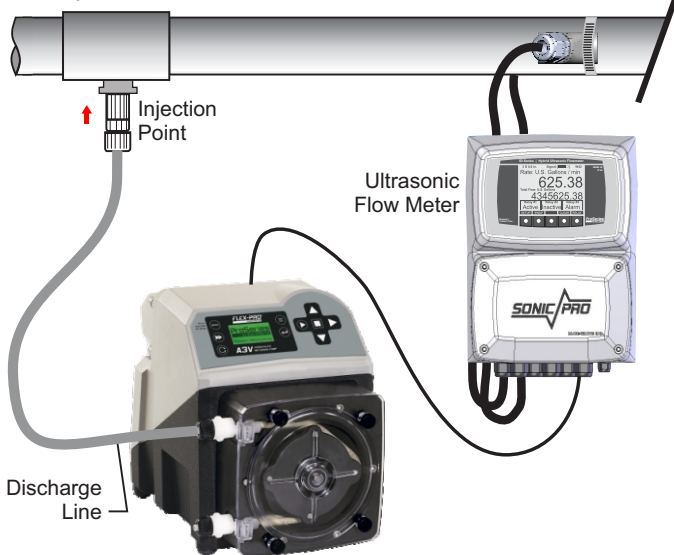

Example #2, Paddlewheel flow meter

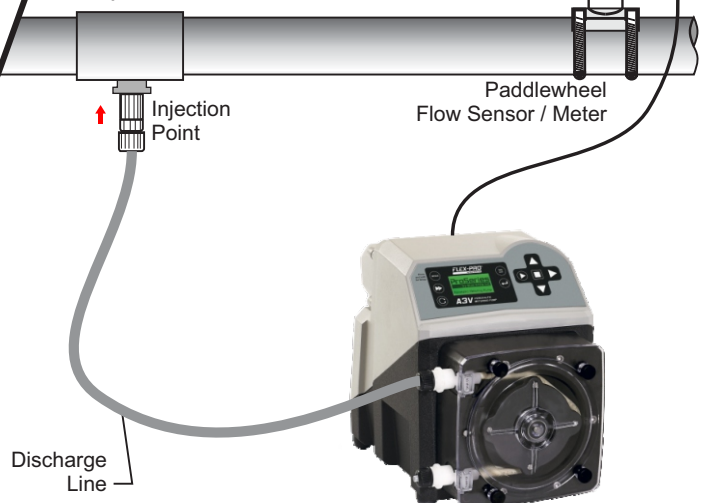

Tip! 

In Proportional Dosing mode, you can view current incoming signal count and settings by pressing RIGHT arrow (see screen shots). RIGHT arrow is a convenient way to scroll through multiple read-only screens during normal operating mode of pump.

- Screen Shot -

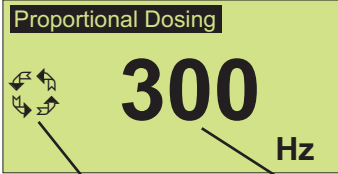

- Screen Shot -

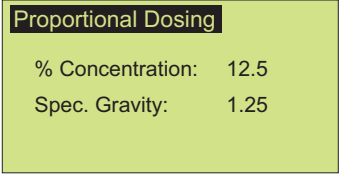

Displays current rotor direction

Displays current incoming signal

4.4 Contact Closure Input

Used to remotely start and stop pump using a close=stop or open=stop signal. If pump should start on an open, then select "Close: Stop Pump" option. Can be used with an external foot pedal, a PLC, contact closure, or other similar external devices.

- Default settings: Disable
- CC Input Range: 6 - 30 VDC
- or**
- Dry Contact Closure (no voltage required)
- [See section 5.1 for wire connections]

Navigate to **Contact Input** menu by MENU button, then selecting Input Setup, and then **Contact Input**.

Press UP or DOWN arrow to scroll through your options.

Press ENTER to make a selection. You should then notice radio button (square box) is now filled in next to your selection.

Press DOWN arrow to scroll down to Done selection. Then press ENTER.

To navigate back out of menus, select <-Esc and press the ENTER button at bottom of every screen menu until you see Run Mode screen displayed.

IMPORTANT: If Contact Closure Input is enabled, pump will display STANDBY if pump is in Stop mode via the Contact Closure. **Please use caution in this mode. Pump can Start at anytime. If you must perform maintenance to the pump, Press STOP button.**

When Contact Closure Input is enabled, the word **Remote** will be displayed on lower left side of screen at all times.

- Menu

- + Configuration
- + **Input Setup**
- + Pump Output
- <- Esc

- Input Setup

- + Motor - Select RPM
- + Tubing - Max Flowrate
- + Operating Input Modes
- + **Contact Closure Input**
- + Set FVS

<- Esc Hidden

- Contact Closure Input

- Close: Stop Pump
- Open: Stop Pump
- Disable
- Done**

- Sample Screen Shots -

Signal stopped pump

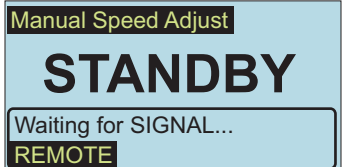

Signal started pump

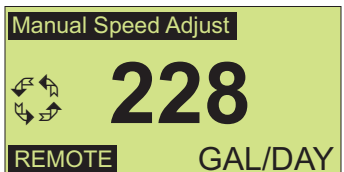
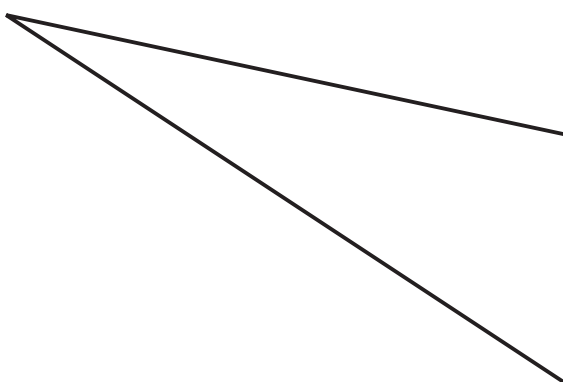
4.5 Set FVS (Flow Verification System)

Used to monitor pump output. If pump does not dispense fluid when pump head rotor is turning, pump will go into an alarm mode and stop pump. Blue-White offers a flow verification sensor that can easily attach to fitting on pump.

Default settings: 000 (off)

Navigate to **Set FVS** menu by pressing MENU button, then selecting Input Setup, and then **Set FVS**.

Press UP or DOWN arrow to scroll through 0 - 9 on selected digit.

Press RIGHT arrow to scroll over to next digit to right. If you pass your desired digit, you can easily scroll back by continuously pressing RIGHT button.

Press ENTER to save changes and exit FVS screen.

To navigate back out of menus, select <-Esc and press ENTER button at bottom of every screen menu until you see Run Mode screen displayed.

Flow Verification System (sensor sold separately)

A3 is equipped with a *Flow Verification System* which is designed to stop pump and provide a contact closure output or 10 amp relay output (setup in software) in event sensor does not detect chemical during pump operation. This could indicate a clogged injection fitting, empty chemical solution tank, worn pump tube, loose tubing connection, etc.

To allow pump to clear any gasses that may have accumulated during stopper operation (such as with chlorine), an alarm delay time value from 1-255 seconds must be programmed (An alarm delay value of 000 seconds disables FVS system).

If FVS alarm occurs, pump will stop, send an external signal (if setup), and screen will flash FVS with an alarm icon.

To clear FVS alarm, you must press START button or re-cycle power (unplug power to pump, then plug back in).

Install FVS Flow Sensor - Flow Verification Sensor (FVS) should be installed on the inlet (suction) side of the pump tube. Sensor includes a PVC tubing insert, located inside sensors female thread connection, that is designed to seal sensor onto pump tube inlet adapter. Thread sensor onto pump tube until tubing insert is snug against pump tube inlet fitting - do not over-tighten.

Confirm the FVS flow range - Flow Verification Sensor (FVS) will only function within its operating range. Sensor model FV-100 has an operating range of 30-300 ml/min (1-10 oz/min) when used as a flowmeter. However, due to pressure drop across the sensor, the pump's suction capability is limited to 14.7 psi. Therefore, when used with the peristaltic pump as a flow verification sensor, the effective operating range is reduced to 30-200 ml/min. Note that if the pump's output is less than 30 ml/min, the sensor will not detect chemical and a signal will not be sent to pump.

SENSOR MODEL NUMBER	PUBLISHED FLOW RANGE (ml/min)	ACTUAL WORKING RANGE WITH FLEX-PRO PUMP (ml/min)
FV-100	30-300	30-200
FV-200	100-1000	50-900
FV-300	200-2000	100-1800
FV-400	300-3000	300-3000
FV-500	500-5000	500-5000
FV-600	700-7000	700-7000

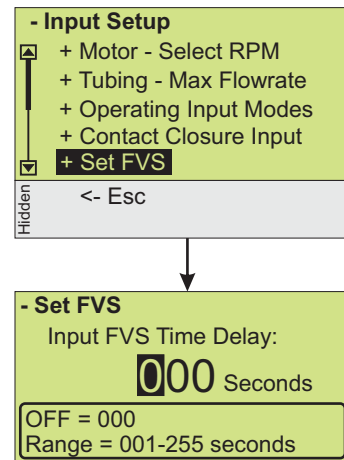

When a FVS alarm occurs

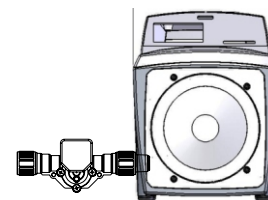

4.6 TFD (Tube Failure Detection)

Flex-Pro is equipped with a *Tube Failure Detection System* which is designed to stop pump and provide an output alarm (see Output menu) in the event pump tube should rupture and chemical enters pump head. This patented system is capable of detecting presence of a large number of chemicals including Sodium Hypochlorite (Chlorine), Hydrochloric (muriatic) Acid, Sodium Hydroxide, and many others. System will not be triggered by water (rain, condensation, etc.) or silicone oil (roller and tubing lubricant).

If system has detected chemical, pump tube must be replaced and pump head and roller assembly must be thoroughly cleaned. Failure to clean the roller assembly will void warranty.

If TFD alarm occurs, pump will stop, close an alarm output (if configured), and screen will flash TFD with an alarm icon.

Confirm Chemical Detection - To determine if your chemical will be detected by system, remove pump tube and roller assembly. Place a small amount of chemical in bottom of pump head - just enough to cover sensors. Turn on pump. If TFD system detects chemical, pump will stop after a two second confirmation period and TFD Alarm screen will display. If TFD system does not detect chemical, pump will continue to run after confirmation period. Carefully clean chemical out of pump head being sure to remove all traces of chemical from sensor probes. Press START button to clear alarm condition and restart pump.

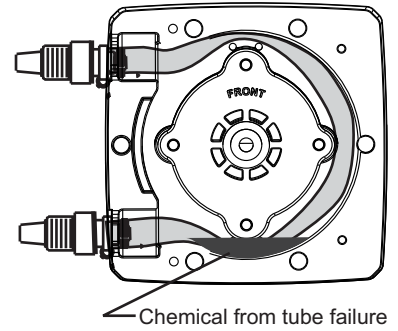

When a TFD alarm occurs



4.6.1 TFD Adjustment

Flex-Pro Tube Failure Detection (TFD) sensitivity can be adjusted through the menu. Default setting (75% sensitivity) will trigger an alarm with most water treatment chemicals with no false triggering.

TFD sensitivity range = 75% to 100%

To set TFD sensitivity, press ENTER when INPUT SETUP is highlighted. Scroll down and highlight SET TFD and press ENTER

To increase sensitivity, press UP arrow.

To decrease sensitivity, press DOWN arrow.

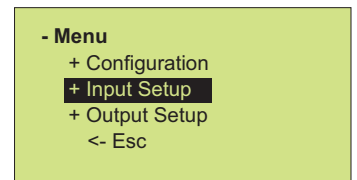

It is recommended to leave default setting at 75% sensitivity. This will eliminate your chance of false triggers.
Only increase sensitivity if the solution your pumping does not trigger the TFD alarm at 75% sensitivity.

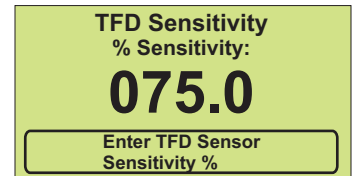

4.7 Remote/Local Control

The Flex-Pro can be configured for Remote control only, Local control only, or either (disabled).

When set for Remote control only, all touch pad buttons except the menu button are disabled. To completely lock out the menu, configure a password (see page 12, section 8). If REMOTE ONLY is selected, the user is prompted to select an input operating mode which must then be used when operating the pump.

When set for local control only, all input signals including the remote start/stop are disabled. Note that the “contact closure input” menu setting (section 4.4) is switched to “disabled” while **LOCAL ONLY** is selected. This menu setting will return to the previous setting when **REMOTE ONLY** or **DISABLED** is selected.

NOTE/CAUTION: With certain firmware versions of this pump, the “contact closure input” may need to be set again to the desire setting “Close, Open, Disable” when activating **REMOTE ONLY**. **Always re-confirm “contact closure” setting when running in REMOTE ONLY.**

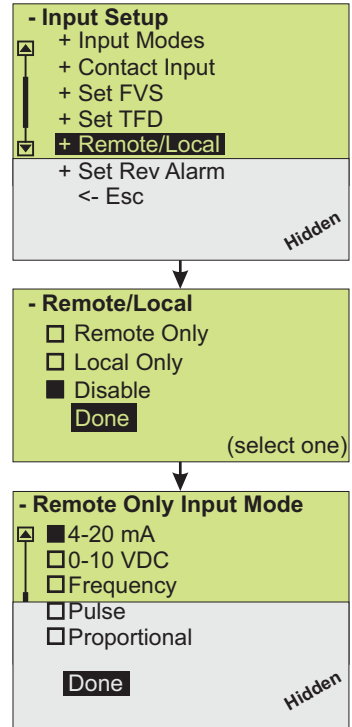

4.8 Pump Tube Timer

Flex-Pro has a built in Pump Tube Timer. Timer starts when rotor is rotating and stops when rotor is idle. To view current Pump Tube Timer value, press ENTER and DOWN arrow at same time while in the normal operating mode.

Screen will display current Pump Tube Time in run-time hours. While displayed, press ENTER button twice to reset Pump Tube Timer to zero.

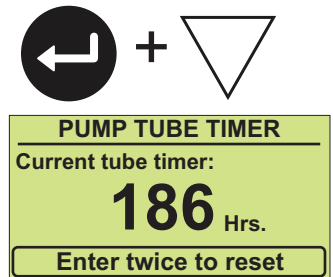

5.0 Output Setup (alarm relays)

- Menu
 + Configuration
 + Input Setup
+ Output Setup
 + Power Fail option
 <- Esc

Note:
 Contact #1 shown only. Contact #2, and Contact #3 use the same menu items.

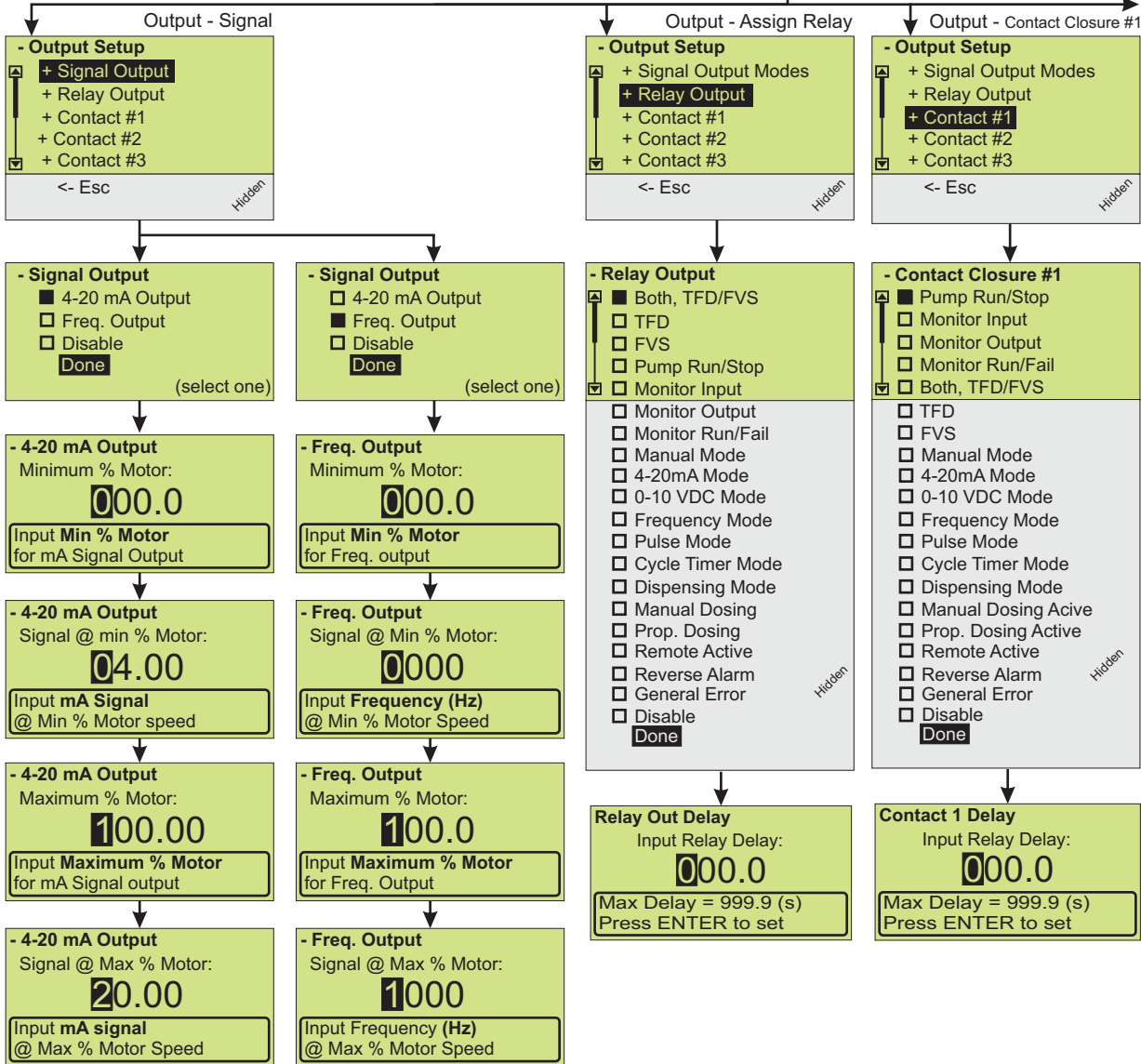

Description of Relay and Contact Closure Output triggers

Selection: **Contact energizes when:**

Pump Run/StopMotor turning (roller assembly is rotating).

Monitor InputIncoming analog or digital signal is not received or is out of range.

Monitor Output.....Outgoing analog or digital signal not transmitted or is out of range.

Monitor Run/Fail.....Motor fails to respond to commands from the internal controller.

Both TFD/FVS.....Either TFD or FVS system triggers.

FVSAfter the programmed delay time, pulses are not received from flow sensor.

TFDTube failure is detected by sensors in the head.

Active Mode.....The selected run mode is currently activated.

Remote ActiveEnergized when Remote only is activated.

Reverse Alarm.....The motor revolution is reversed (turning clock-wise).

General Error.....A motor overload or other internal error has occurred.

Disable.....Output alarm contact is disabled.

5.1 Signal Output

Sends a configurable 4 - 20 mA or frequency (Hz) signal to another pump or external device. This feature can be used to control other pumps (in sync / proportionally), data logging systems, and other external devices for plant automation.

Default settings: Disable

Navigate to **Signal Output** menu by pressing MENU button, then selecting Output Setup, and then **Signal Output**.

Select your desired Signal output using UP or DOWN arrows.

Press ENTER to configure output signal.

Press UP or DOWN arrow to scroll through 0 - 9 on selected digit.

Press RIGHT arrow to scroll over to next digit to right. If you pass your desired digit, you can easily scroll back by continuously pressing RIGHT button.

Press ENTER to save changes.

Continue this process until all four screens have been configured.

To navigate back out of menu structure you must select <-Esc at bottom of every screen menu until you see Run Mode screen displayed.

Example 1

0% Pump Output = 4 mA
100 % Pump Output = 20 mA

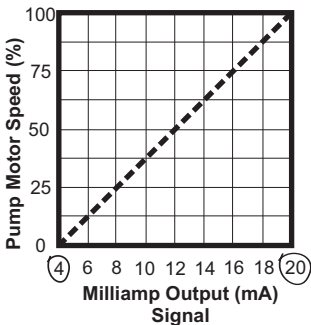

Example 2

0% Pump Output = 4 mA
50% Pump Output = 16 mA

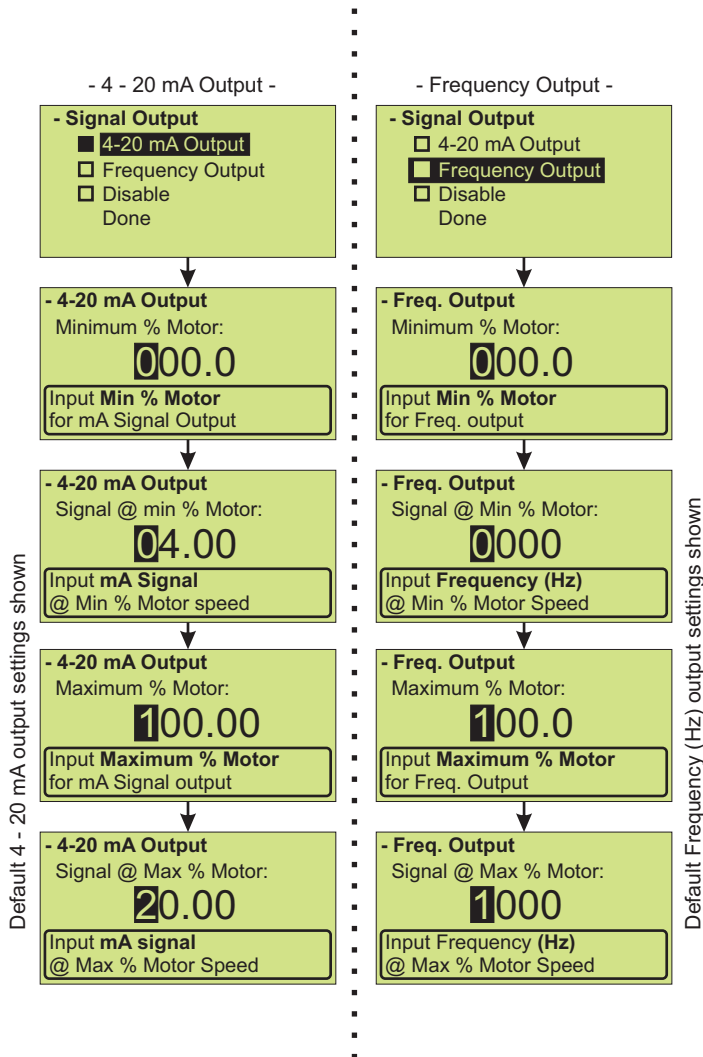
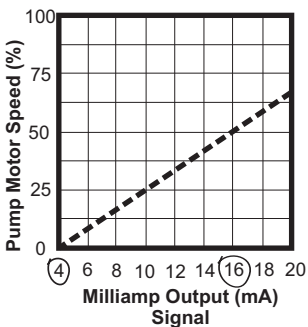

Example 1

0% Pump Output = 0 Hz
100 % Pump Output = 1000 Hz

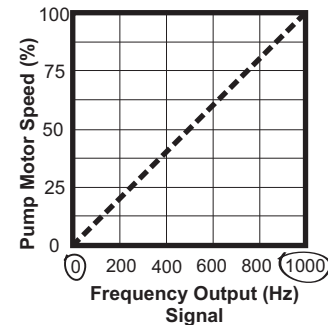

Example 2

0% Pump Output = 1000 Hz
100% Pump Output = 0 Hz

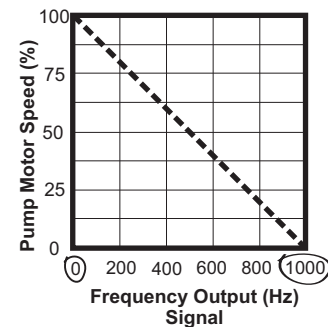

6.0 Pump Maintenance

CAUTION



Always wear protective clothing, face shield, safety glasses and gloves when working on or near your metering pump. Additional precautions should be taken depending on solution being pumped. Refer to MSDS precautions from your solution supplier.

6.1 Routine Inspection and Maintenance

The pump requires very little maintenance. However, the pump and all accessories should be checked weekly. This is especially important when pumping aggressive chemicals. Inspect all components for signs of leaking, swelling, cracking, discoloration or corrosion. Replace worn or damaged components immediately.

Cracking, crazing, discoloration and the like during first week of operation are signs of severe chemical attack. If this occurs, immediately remove chemical from pump. Determine which parts are being attacked and replace them with parts that have been manufactured using more suitable materials.

6.2 How to Clean and Lubricate the Pump

When changing the pump tube assembly, the pump head chamber, roller assembly and pump head cover should be wiped free of any dirt and debris.

100% silicone lubrication may be used on the roller assembly. Refer to Blue-White.com/videos for roller assembly maintenance video instructions.

Periodically clean the back flow prevention check valve assembly, especially when injecting fluids that calcify such as sodium hypochlorite. These lime deposits and other build ups can clog the fitting, increasing the back pressure at the pump (reducing tube life) and interfering with check valve operation.

The motor does not require maintenance or lubrication.

6.3 Reverse Rotor Rotation

The pump rotor can reverse rotation by pressing REVERSE ROTATION button.

In most applications, the tube will fail by developing a small leak in the outlet side (pressure side) of the tube assembly. By reversing the roller rotation, the wear point in the tube is moved to the opposite side of the pump tube assembly, increasing the life of the tube.

Reversing rotation, moves the outlet side (pressure side) to the opposite side of the tube assembly, greatly increasing the tube life.

Stop the pump before the tube failure occurs.

Disconnect power from the pump. Carefully purge any pressure in the discharge line of the pump. Disconnect the suction end tubing/piping and the discharge end tubing/piping from the pump head tubing.



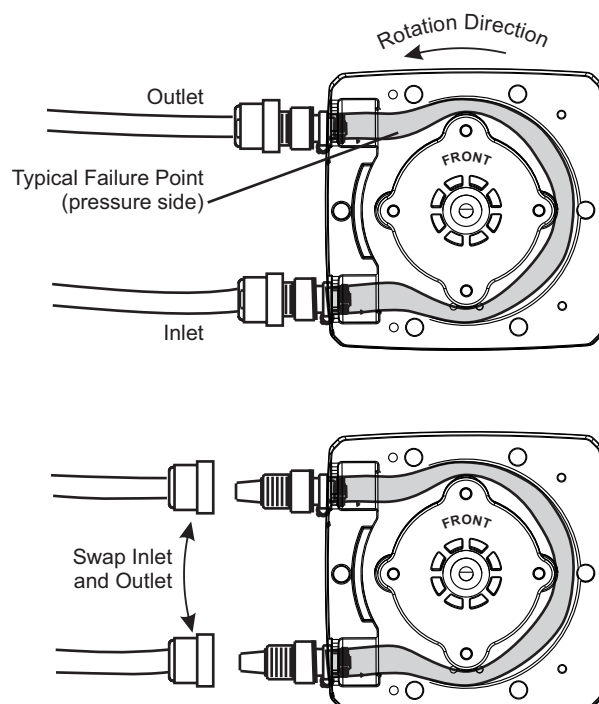

IMPORTANT! Swap sides of the suction (inlet) and discharge (outlet) tubing/piping. There is no need to remove the Pump Head Cover.

Double check all connections before starting the pump

NOTE: The pump tube will form a natural U-shaped curve. Do not attempt to install the pump tube against the natural U-shape direction as damage to the tube can result.



6.4 Tube Replacement

CAUTION 	Prior to service, pump clean water through the pump and suction / discharge line to remove chemical.
CAUTION 	Always wear protective clothing, face shield, safety glasses and gloves when working on or near your metering pump. Additional precautions should be taken depending on solution being pumped. Refer to MSDS precautions from your solution supplier.
CAUTION 	Use provided Tube Installation Tool to leverage tubing into pump head, <u>NOT YOUR FINGERS.</u>
CAUTION 	Use extreme caution when replacing pump tube. <u>DO NOT</u> place fingers near rollers.

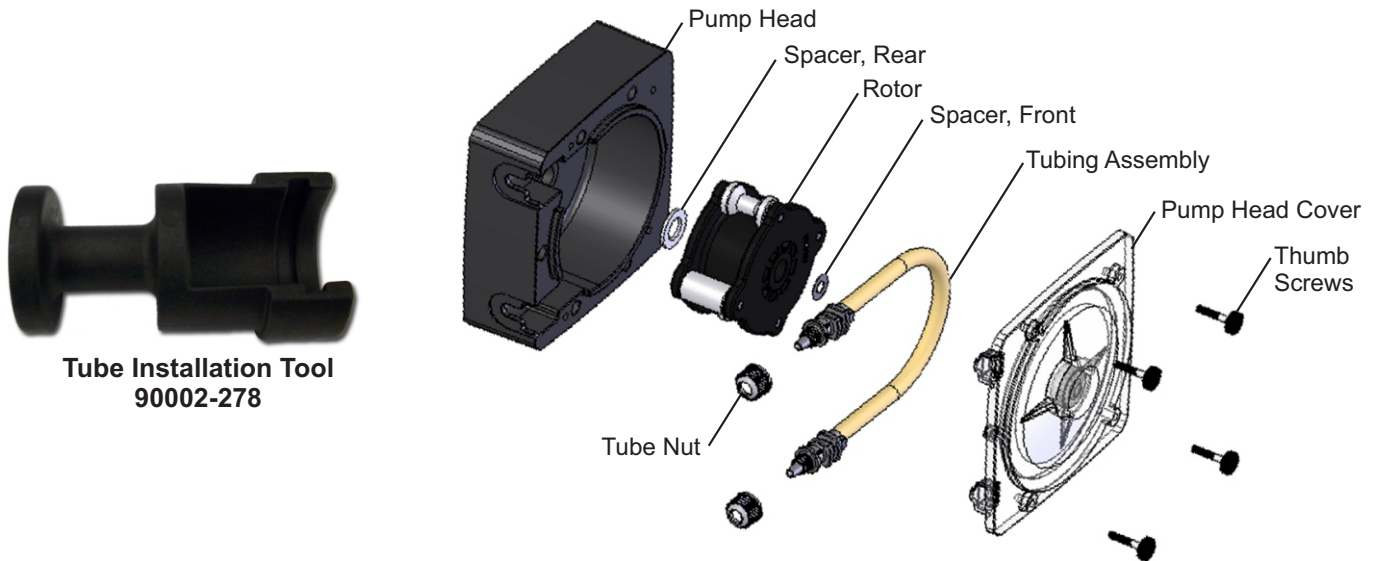

Remove **Pump Head Cover** by unscrewing four **Thumb Screws**. Pull out **Pump Head Cover**.

Pump will detect **Pump Head Cover** is removed and enter MAINTENANCE MODE.

Rotor will rotate at a maximum of 6 RPM for your safety.

Pull out suction side of **Tubing Assembly**.

Press START button. While rotor is rotating, pull out old **Tube Assembly**.

TIP! Let pump do the work for you. Just guide tubing out between two rollers located on **Rotor**.

Press STOP button at any time to stop the pump.

Pull out suction line adapter from Pump Head. Pull out **Tubing Assembly** as the **Rotor** rotates around.

Stop pump by pressing STOP button.

Thoroughly clean **Pump Head** and **Rotor**. **Rotor** can be removed by pulling straight out. After cleaning process, push **Rotor** back on shaft. See drawing above for proper assembly. IMPORTANT! **Rotor** direction; the word "FRONT" on **Rotor** must face front of pump.

Locate your new tubing and Tube Installation Tool. Please see next page on how to install new **Tube Assembly** into **Pump Head**.

MAINTENANCE MODE

Pump Cover Removed!

MAINTENANCE MODE

- Cover was removed!
- Motor Speed = 6 RPM

Press **START** to run
Press **STOP** to stop

Tip! Apply silicone oil to the outside of Flex-A-Thane tubes for longer tube life.

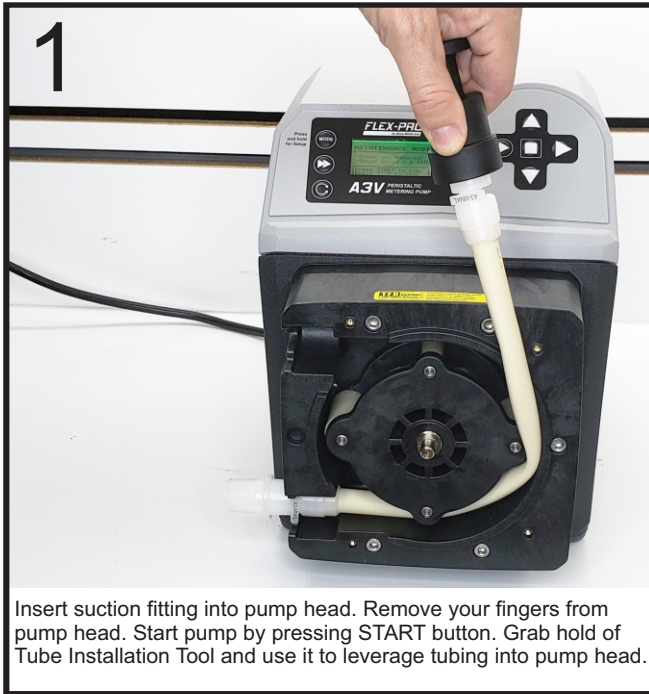

1
Insert suction fitting into pump head. Remove your fingers from pump head. Start pump by pressing START button. Grab hold of Tube Installation Tool and use it to leverage tubing into pump head.



2
Introduce tubing into pump head while the rotor is rotating. Avoid using fingers to guide the tubing. Stop pump at anytime by pressing STOP button. Start pump by pressing START button.



3
Continue to follow rotation of rotor while directing tube into pump head. At this point, you may need to pull Tube Installation Tool to stretch tubing into position. Let rotor spin a few rotations while pulling Installation tool so fitting can be properly installed.



4
Continue to pull Tube Installation Tool to allow enough room to slide discharge fitting into pump head tongue and groove. Once discharge fitting is secured in pump head, stop pump by pressing STOP button. Replace pump head cover. Pump will ask you if you'd like to reset tube timer. If you choose yes, current tube time will display for 5 seconds before resetting to zero. Make note of your displayed tube life. Select Yes again to reset tube life timer.

Re-attach **Pump Head Cover** using the four **Thumb Screws**.

Pump will detect **Pump Head Cover** is installed and begin to exit MAINTENANCE MODE.

Pump will ask you if Tube was replaced. Yes / No

If Yes is selected, pump ask you to reset Tube Timer. Yes / No

If Yes is selected, pump will display Current Tube Timer briefly (5 seconds) before resetting to zero.

The pump can now begin normal operation.

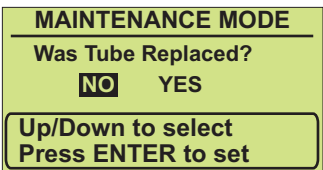
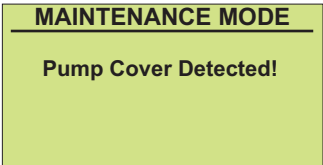

6.5 FlexFlo Model A3 replacement parts list

	Item	Description	Part Number	QTY
	2	Spacer, Back	90011-184	1
Flex-A-Prene®	3	Roller Assembly Complete (Rotor), For ND Tubes	A3-SND-R	1
	4	Tube Assembly, 3/8" OD tube compression fitting, Flex-A-Prene® ND (.075 ID)	A3-SND-T	1
	4	Tube Assembly, 1/2" Male NPT connect, Flex-A-Prene® ND (.075 ID)	A3-MND-T	1
Flex-A-Prene®	3	Roller Assembly Complete (Rotor), For NJ, NK, NE, and NGG Tubes	A3-SNGG-R	1
	4	Tube Assembly, 3/8" OD tube compression fitting, Flex-A-Prene® NJ (.312 ID)	A3-SNJ-T	1
	4	Tube Assembly, 1/2" Male NPT connect, Flex-A-Prene® NJ (.312 ID)	A3-MNJ-T	1
	4	Tube Assembly, 3/8" OD tube compression fitting, Flex-A-Prene® NK (.375 ID)	A3-SNK-T	1
	4	Tube Assembly, 1/2" Male NPT connect, Flex-A-Prene® NK (.375 ID)	A3-MNK-T	1
	3	Roller Assembly Complete (Rotor), For NKL Tubes	A3-STH-R	1
	4	Tube Assy, 3/8" OD tube comp, Flex-A-Prene® NKL (.375 ID) Low Pressure (30 psi max)	A3-SNKL-T	1
	4	Tube Assy, 1/2" Male NPT, Flex-A-Prene® NKL (.375 ID) Low Pressure (30 psi max)	A3-MNKL-T	1
Flex-A-Prene®	3	Roller Assembly Complete (Rotor), For NJ, NK, NEE and NGG Tubes	A3-SNGG-R	1
	4	Tube Assembly, Quick Disconnect, Flex-A-Prene® NEE (0.093 ID)*	A3-QNEE-T	1
	4	Tube Assembly, 3/8" OD tube compression fitting, Flex-A-Prene® NEE (0.093 ID)	A3-SNEE-T	1
	4	Tube Assembly, 1/2" Male NPT, Flex-A-Prene® NEE (0.093 ID)	A3-MNEE-T	1
	4	Tube Assembly, 1/2" Hose Barb, Flex-A-Prene® NEE (0.093 ID)	A3-BNEE-T	1
	4	Tube Assembly, 1/2" - 3/4" tri-clamp (Sanitary Fitting), Flex-A-Prene® NEE (0.093 ID)	A3-CNEE-T	1
	4	Tube Assembly, Quick Disconnect, Flex-A-Prene® NGG (0.187 ID)*	A3-QNGG-T	1
	4	Tube Assembly, 3/8" OD tube compression fitting, Flex-A-Prene® NGG (0.187 ID)	A3-SNGG-T	1
	4	Tube Assembly, 1/2" Male NPT, Flex-A-Prene® NGG (0.187 ID)	A3-MNGG-T	1
	4	Tube Assembly, 1/2" Hose Barb, Flex-A-Prene® NGG (0.187 ID)	A3-BNGG-T	1
	4	Tube Assembly, 1/2" - 3/4" tri-clamp (Sanitary Fitting), Flex-A-Prene® NGG (0.187 ID)	A3-CNGG-T	1
Flex-A-Chem®	3	Roller Assembly Complete (Rotor), For TH Tubes	A3-STH-R	1
	4	Tube Assembly, 3/8" OD tube compression fitting, Flex-A-Chem® TH (.250 ID)	A3-STH-T	1
	4	Tube Assembly, 1/2" Male NPT, Flex-A-Chem® TH (.250 ID)	A3-MTH-T	1
	3	Roller Assembly Complete (Rotor), For TK Tubes	A3-SNGG-R	1
	4	Tube Assembly, 3/8" OD tube compression fitting, Flex-A-Chem® TK (.375 ID)	A3-STK-T	1
	4	Tube Assembly, 1/2" Male NPT, Flex-A-Chem® TK (.375 ID)	A3-MTK-T	1
Flex-A-Thane®	3	Roller Assembly Complete (Rotor), For GE, GG, GH, GK, G2G Tubes	A3-SGE-R	1
	4	Tube Assembly, 3/8" OD tube compression fitting, Flex-A-Thane® GE (.125 ID)	A3-SGE-T	1
	4	Tube Assembly, 1/2" Male NPT connect, Flex-A-Thane® GE (.125 ID)	A3-MGE-T	1
	4	Tube Assembly, 3/8" OD tube compression fitting, Flex-A-Thane® GG (.187 ID)	A3-SGG-T	1
	4	Tube Assembly, 1/2" Male NPT connect, Flex-A-Thane® GG (.187 ID)	A3-MGG-T	1
	4	Tube Assembly, 3/8" OD tube compression fitting, Flex-A-Thane® GH (.250 ID)	A3-SGH-T	1
	4	Tube Assembly, 1/2" Male NPT connect, Flex-A-Thane® GH (.250 ID)	A3-MGH-T	1
	4	Tube Assembly, 3/8" OD tube compression fitting, Flex-A-Thane® GK (.375 ID)	A3-SGK-T	1
	4	Tube Assembly, 1/2" Male NPT connect, Flex-A-Thane® GK (.375 ID)	A3-MGK-T	1
	4	Tube Assembly, 3/8" OD tube compression fitting, Flex-A-Thane® G2G (.187 ID)	A3-SG2G-T	1
	4	Tube Assembly, 1/2" Male NPT connect, Flex-A-Thane® G2G (.187 ID)	A3-MG2G-T	1
	6	Pump Head Cover, Polycarbonate - New design, backwards compatible	A3-SXX-C	1
	7	Thumb Screw	90011-183	4
	8	Tube Nut, Compression, For 3/8" Tubing	C-330-6	2
Not Shown		Stainless Steel mounting bracket kit (pair)	72000-379	1
Not Shown		Stainless Steel extended mounting bracket kit (pair)	72000-380	1
Not Shown		Rubber feet	90003-561	4

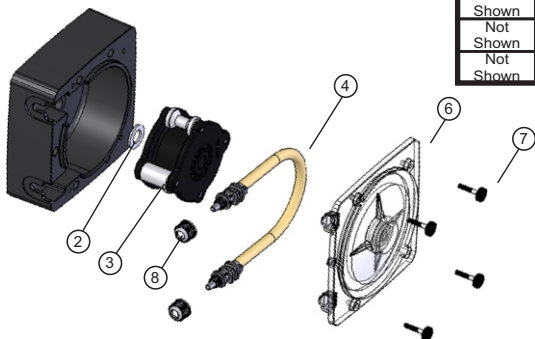

Flex-A-Prene® Upgrade Kit

Model #	Description
72000-537	Roller Assembly and Pump Head Cover

Upgrade existing A3 pumps with Flex-A-Prene® Upgrade Kit to be compatible with all new Flex-A-Prene® tubes.

*Quick Disconnect valves sold separately.

Note: ND and NKL tube assemblies are also available in "B", "C" and "Q" connection types.

6.6 FlexFlo Model A4 replacement parts list

	Item	Description	Part Number	QTY
	2	Spacer, two spacers required, A4 (replaces 90011-184)	90011-217	1
Flex-A-Prene®	Tubing in this group are interchangeable with single roller assembly (rotor). Dual tube designs are Patent Pending			
	3	Roller Assy Complete (A4 Rotor), For NH, NJ, NK, NHH Tubes	A4-MNH-R	1
	4	Tube Assembly, 1/2" hose barb, Flex-A-Prene® NH (.25 ID)	A4-BNH-T	1
	4	Tube Assembly, 1/2" Male NPT, Flex-A-Prene® NH (.25 ID)	A4-MNH-T	1
	4	Tube Assembly, Quick Disconnect, Flex-A-Prene® NH (0.25 ID)*	A4-QNH-T	1
	4	Tube Assembly, 1/2" hose barb, Flex-A-Prene® NJ (.31 ID)	A4-BNJ-T	1
	4	Tube Assembly, 1/2" Male NPT, Flex-A-Prene® NJ (.31 ID)	A4-MNJ-T	1
	4	Tube Assembly, Quick Disconnect, Flex-A-Prene® NJ (0.31 ID)*	A4-QNJ-T	1
	4	Tube Assembly, 1/2" Male NPT, Flex-A-Prene® NK (0.38 ID)	A4-MNK-T	1
	4	Tube Assembly, Quick Disconnect, Flex-A-Prene® NK (0.38 ID)*	A4-QNK-T	1
4	Tube Assembly, 1/2" Male NPT, Multi-Tube Flex-A-Prene® NHH (.25 + .25 ID)	A4-MNHH-T	1	
4	Tube Assembly, 1/2" Male NPT, Multi-Tube Flex-A-Prene® NHH (.25 + .25 ID)	A4-MNHH-T	1	
Flex-A-Prene®	Tubing in this group are interchangeable with single roller assembly (rotor).			
	3	Roller Assy Complete (A4 Rotor), For NL, NP Tubes	A4-MNL-R	1
	4	Tube Assembly, 1/2" hose barb, Flex-A-Prene® NL (.50 ID)	A4-BNL-T	1
	4	Tube Assembly, 1/2" Male NPT, Flex-A-Prene® NL (.50 ID)	A4-MNL-T	1
	4	Tube Assembly, Quick Disconnect, Flex-A-Prene® NL (.50 ID)*	A4-QNL-T	1
	4	Tube Assembly, 1/2" hose barb, Flex-A-Prene® NP (.75 ID)	A4-BNP-T	1
	4	Tube Assembly, 1/2" Male NPT, Flex-A-Prene® NP (.75 ID)	A4-MNP-T	1
4	Tube Assembly, Quick Disconnect, Flex-A-Prene® NP (.75 ID)*	A4-QNP-T	1	
Flex-A-Chem®	Tubing in this group are interchangeable with single roller assembly (rotor). Dual tube designs are Patent Pending			
	3	Roller Assy Complete (A4 Rotor), For TH, TK, THH, TKK Tubes	A4-MTH-R	1
	4	Tube Assembly, 1/2" hose barb, Flex-A-Chem® TK (.38 ID)	A4-BTK-T	1
	4	Tube Assembly, 1/2" Male NPT, Flex-A-Chem® TK (.38 ID)	A4-MTK-T	1
	4	Tube Assy, 1/2" hose barb, Multi-Tube Flex-A-Chem® TK & TK (.38 + .38 ID)	A4-BTKK-T	1
4	Tube Assy, 1/2" Male NPT, Multi-Tube Flex-A-Chem® TK & TK (.38 + .38 ID)	A4-MTKK-T	1	
Flex-A-Thane®	Tubing in this group are interchangeable with single roller assembly (rotor). Dual tube designs are Patent Pending			
	3	Roller Assy Complete (A4 Rotor), For GH, GK, GHH, GKK Tubes	A4-MGH-R	1
	4	Tube Assembly, 1/2" hose barb, Flex-A-Thane® GH (.25 ID)	A4-BGH-T	1
	4	Tube Assembly, 1/2" Male NPT, Flex-A-Thane® GH (.25 ID)	A4-MGH-T	1
	4	Tube Assembly, 1/2" hose barb, Flex-A-Thane® GK (.38 ID)	A4-BGK-T	1
	4	Tube Assembly, 1/2" Male NPT, Flex-A-Thane® GK (.38 ID)	A4-MGK-T	1
	4	Tube Assy, 1/2" hose barb, Multi-Tube Flex-A-Thane® GH & GH (.25 + .25 ID)	A4-BGHH-T	1
	4	Tube Assy, 1/2" Male NPT, Multi-Tube Flex-A-Thane® GH & GH (.25 + .25 ID)	A4-MGHH-T	1
	4	Tube Assy, 1/2" hose barb, Multi-Tube Flex-A-Thane® GK & GK (.38 + .38 ID)	A4-BGKK-T	1
	4	Tube Assy, 1/2" Male NPT, Multi-Tube Flex-A-Thane® GK & GK (.38 + .38 ID)	A4-MGKK-T	1
Not Shown	Stainless Steel mounting bracket kit (pair)	72000-379	1	
Not Shown	Stainless Steel extended mounting bracket kit (pair)	72000-380	1	
Not Shown	Rubber feet (4 required per pump, sold individually)	90003-561	1	

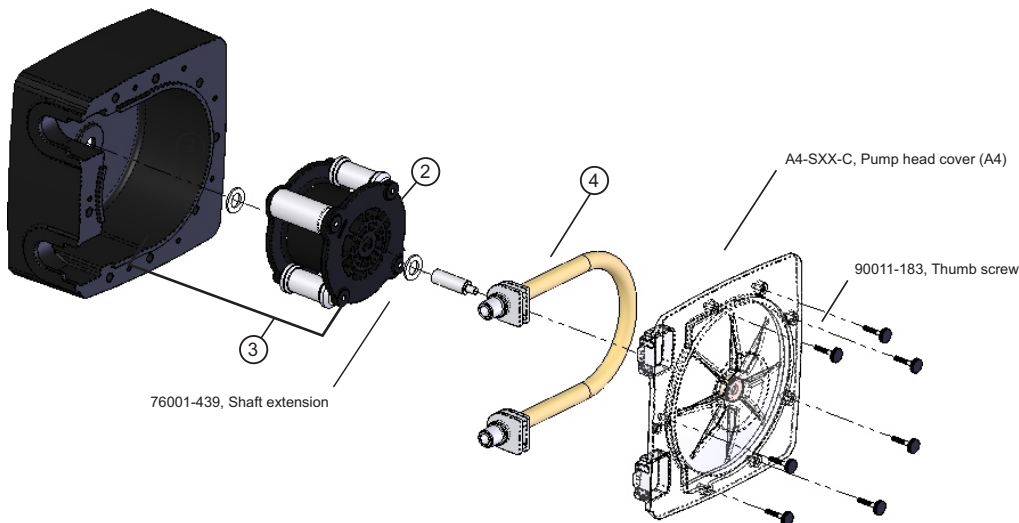



Users of electrical and electronic equipment (EEE) with the WEEE marking per Annex IV of the WEEE Directive must not dispose of end of life EEE as unsorted municipal waste, but use the collection framework available to them for the return, recycle, recovery of WEEE and minimize any potential effects of EEE on the environment and human health due to the presence of hazardous substances. The WEEE marking applies only to countries within the European Union (EU) and Norway. Appliances are labeled in accordance with European Directive 2002/96/EC.
Contact your local waste recovery agency for a *Designated Collection Facility* in your area.

5300 Business Drive, Huntington Beach, CA 92649 USA

Phone: 714-893-8529 **FAX:** 714-894-9492

E mail: sales@blue-white.com **or** customerservice@blue-white.com **URL:** www.blue-white.com