

A1A

FLEXFLO® Peristaltic Metering Pump

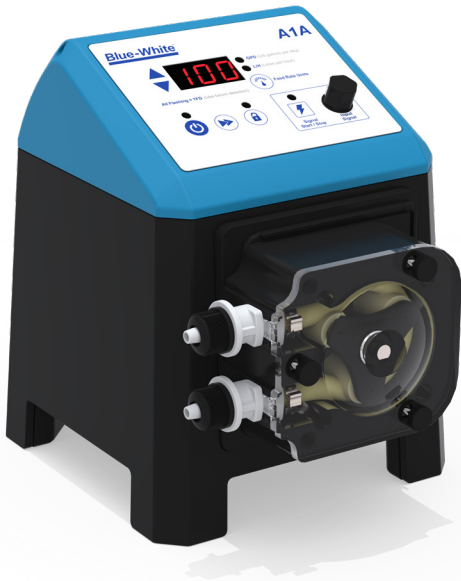

Features

- > Specially designed for pools, spas, and water parks
- > Self priming peristaltic metering pump delivers smooth chemical feed
- > Patented Tube Failure Detection (TFD) system senses tube failure
- > Inputs include: Remote Start/Stop, one relay input

Video link: 



NEMA 4X

Highlights

Flow range

.01 - 100 GPD
.01 - 15.8 LPH

Pressures

40 PSI
(2.76 bar)

Turndown ratio

10,000 : 1

Exclusive

Tube Failure Detection (TFD)

Motor

Brushless DC Motor

Warranty

2 Years

Control Methods

Control Methods	Manual Control	Remote Start/Stop	Relay Input
A1A	•	•	•



Engineering Specifications

A1A

Maximum Working Pressure (excluding pump tubes)	40 psig (2.76 bar) NOTE: See individual pump tube assembly maximum pressure ratings.
Maximum Suction Lift	30 ft. of water at sea level (14.7 atm psi)
Ambient Operating Temperature	14 °F to 115 °F (-10 °C to 46 °C)
Ambient Storage Temperature	-40 °F to 158 °F (-40 °C to 70 °C)
Operating Voltage	115V 60Hz 1 PH (0.6A max.)
	220V 50Hz 1 PH (0.3A max.)
	230V 60Hz 1 PH (0.3A max.)
	230V 50Hz 1 PH (0.3A max.)
	240V 50Hz 1 PH (0.3A max.)
Power Cord Options	115V 50/60Hz = NEMA 5/15 (USA)
	230V 50/60Hz = NEMA 6/15 (USA)
	220V 50/60Hz = CEE 7/VII (EU)
	240V 50/60Hz = AS 3112 (Australia/New Zealand)
	230V 50/60Hz = 1363/A (United Kingdom)
Motor	Brushless DC, 50W
Duty Cycle	Continuous
Flow Range Adjustment	0.01 - 100 GPD (0.01 - 15.8 LPH)
Maximum Overall Dimensions	7.25" W x 9" H x 10" D (18.5 W x 22.9 H x 25.2 D cm)
Product Weight	6 lb. (2.7 Kg)
Approximate Shipping Weight	13 lb. (5.9 Kg)
Approximate Shipping Dimensions	10.5" W x 13.75" H x 11" D (26.7 W x 35 H x 28 D cm)
Enclosure	NEMA 4X (IP66), Valox (PBT) & PA12
RoHS Compliant	Yes
Standards	cETLus, CE, NSF50

Output Specifications

Tube Model	Feed Rate		Max. Speed	Max. Pressure	Max. Temperature
	GPD	LPH	RPM	PSI (bar)	°F (°C)
A1-7	0.01 - 100	0.01 - 15.8	65	40 (2.76)	185 (85)

Materials of Construction

A1A

Non-wetted Components:

Enclosure:	Valox® (PBT) & PA12 thermoplastic
Pump Head:	Valox® (PBT) thermoplastic
Pump Head Cover:	Polycarbonate Permanently lubricated sealed motor shaft support bronze sleeve bearing.
Cover Screws:	Stainless steel, polypropylene cap
Roller Assembly:	Rotor: Valox® (PBT) Rollers: Nylon Roller Bearings: Bronze
TFD System Sensor:	Hastelloy C-276
Power Cord:	3 Conductor, SJTW-A water-resistant
Mounting Brackets and Hardware:	316 Stainless steel screws, GF Nylon bracket

Wetted Components:

Pump Head Assembly:	Tubing: Flex-A-Prene® Adapter Fittings: PVDF Body & Insert: Polypropylene Check Ball: Ceramic
Injection / Back-Flow Check Valve:	Spring: Hastelloy C-276 Ball Seat O-Ring: TFE/P Static Seal O-Ring: FKM
Ancillary Items Provided:	Suction Tubing: 3/8" OD x 1/4" ID x 10' Clear PVC Discharge Tubing: 3/8" OD x 1/4" ID x 10' Polyethylene (LLDPE) Suction Strainer: Polypropylene Weight: Ceramic

Dimensions



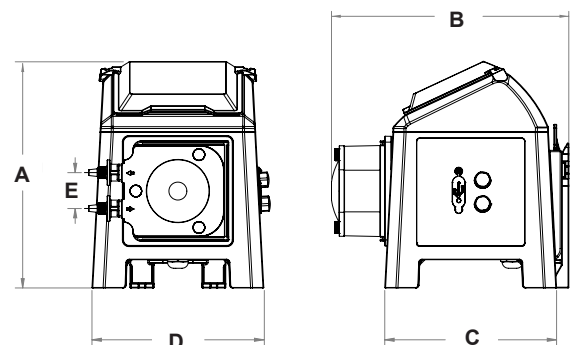





Dim	Inch	cm	Dim	Inch	cm
A	9.46"	24.02	D	7.18"	18.23
B	9.92"	25.19	E	1.5"	3.81
C	7.18"	18.23			

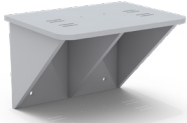

FLEXFLO® Model Number

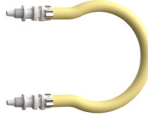
A1A FLEXFLO® Peristaltic Metering Pump				
Power Cord				
4	115V 50/60Hz, power cord NEMA 5/15 plug (US) (detachable - 3.9 ft)			
6	220V 50/60Hz, power cord CEE 7/V11 plug (EU) (detachable - 6 ft)			
X	No Power Cord (Power cord is required - See Accessories for power cord options)			
Pump Tube Material, Pump Tube Size, Operating Flow Range				
7T	Flex-A-Prene® .250 ID .01–100 GPD 40 PSI			
A1A	4	-	7T	Sample Model Number

Accessories

 <p>KIT-S07 STAR III 7 GALLON TANK, PP</p>	 <p>KIT-S15 STAR III 15 GALLON TANK, PP</p>	 <p>KIT-S30 STAR III 30 GALLON TANK, PP</p>	 <p>KIT-PSM WALL MOUNT BRACKET, HDPE</p>
 <p>CABLE-M8 M8 CABLE - 4.9 ft.</p>	<p>90010-716 115V/60Hz NEMA 5/15 90010-664 220V/50Hz CEE 7/V11 90010-665 230V/50Hz BS 1363/A 90010-666 240V/50Hz AS 3112 90010-696 230V/60Hz NEMA 6/15 90010-821 115V Lockable</p> <p>POWER CABLES</p>	 <p>A1-7T Spare Tube Element</p>	
 <p>TI40-6V T.I. INJECTOR, 3/8" OD</p>	 <p>A-014NK-6A PVDF INJECTOR</p>	 <p>C-340A FOOT VALVE</p>	

Visit Accessory Pages for More Options