

CHEM-FEED[®]

Diaphragm Metering Pump



Series MC2 & MC3

1.0	Introduction	4
	1.1 Available Models	4
2.0	Specifications	5
	2.1 Materials of Construction	5
3.0	Features	6
	3.1 Agency Listings	6
4.0	Installation	7
	4.1 Mounting Location	7
	4.2 Dimensions	7
	4.3 Installing Injection Fitting and Strainer	8
5.0	Power Connections	9
	5.1 Wiring Terminal and I/O Schematics	10
6.0	How to Operate CHEM-FEED - Control Pad	11
	6.1 Mode Descriptions	12
7.0	Mode 0 - Set Remote Start/Stop	13
	7.1 Mode 0 - Set DFD Sensitivity	14
	7.2 Mode 0 - Set FVS (Flow Verification System)	15
	7.3 Mode 0 - Set 4-20mA Output	17
	7.4 Mode 0 - Set Flow Rate (Pump Calibration)	19
	7.4.1 Mode 0 - Operation Screens Displaying Flow Rate	20
8.0	Mode 1 - Manual Operation	21
	8.1 Mode 1 - Manual Operation Screen Shots	22
9.0	Mode 2 - 4-20mA Input Operation	23
	9.1 Mode 2 - 4-20mA Input Screen Shots	24
10.0	Mode 3 - Frequency Input (Hz) Operation	25
11.0	Mode 4 - Pulse Batch (low speed pulse) Operation	27
	11.1 Mode 4 - Pulse Batch Operation Screen Shots	28
12.0	Alarm Relay	29
13.0	Volumetric Test - Calibration	29
14.0	Pump Maintenance	30
	14.1 Routine Inspection and Maintenance	30
	14.2 Cleaning Pump	30
	14.3 Replacing the Diaphragm	30
	14.4 Motor Brush Replacement	31
15.0	Replacement Parts List	32
	15.1 MC2 Parts List	32
	15.2 MC3 Parts List	33
16.0	DFD (Diaphragm Detection System)	34
17.0	Output Versus Pressure	35
	17.1 MC2 Output V. Pressure	35
	17.2 MC3 Output V. Pressure	35
18.0	Matrix	36
	18.1 MC2 Matrix	36
	18.2 MC3 Matrix	37
Warranty		39

READ THE INSTRUCTION MANUAL PRIOR TO INSTALLATION AND USE.



+1 (714) 893 - 8529



sales@blue-white.com



customerservice@blue-white.com



5300 Business Drive
Huntington Beach, CA 92649

1.0 Introduction

Congratulations on purchasing CHEM-FEED® variable speed Diaphragm Metering Pump. A diaphragm pump is a type of positive displacement pump used for pumping a variety of fluids.

Your CHEM-FEED® pump is pre-configured for diaphragm, pump head and fittings that shipped with your metering pump.

Please Note: Your new pump has been pressure tested at the factory with clean water before shipping. You may notice trace amounts of clean water in pump head. This is part of our stringent quality assurance program at Blue-White.

1.1 Available Models

MC2 Diaphragm Metering Pump							
166 Strokes per minute							
Feed Rate Range at 0 PSIG			Max Pressure	Connection Type	MC-2 Model Numbers		
GPH	LPH	ML/MIN	PSIG (bar)	Size / Type	115V60 AC	230V60 AC	220V50 AC
.01 - 2.3	.05 - 9.0	0.8 - 150	150 (10)	½" Male NPT	MC-2245XV3	MC-2255XV3	MC-2265XV3
.01 - 2.3	.05 - 9.0	0.8 - 150	150 (10)	½" Female /NPT	MC-2245XV4	MC-2255XV4	MC-2265XV4
.01 - 2.3	.05 - 9.0	0.8 - 150	150 (10)	3/4"OD x 1/2"ID TUBE	MC-2245XV1	MC-2255XV1	MC-2265XV1
.01 - 2.3	.05 - 9.0	0.8 - 150	150 (10)	3/8"OD x 1/4"ID TUBE	MC-2245XV2	MC-2255XV2	MC-2265XV2
.03 - 6.7	.13 - 25.4	2.1 - 423	175 (12)	½" Male NPT	MC-2243XV3	MC-2253XV3	MC-2263XV3
.03 - 6.7	.13 - 25.4	2.1 - 423	175 (12)	½" Female NPT	MC-2243XV4	MC-2253XV4	MC-2263XV4
.03 - 6.7	.13 - 25.4	2.1 - 423	175 (12)	3/4"OD x 1/2"ID TUBE	MC-2243XV1	MC-2253XV1	MC-2263XV1
.03 - 6.7	.13 - 25.4	2.1 - 423	175 (12)	3/8"OD x 1/4"ID TUBE	MC-2243XV2	MC-2253XV2	MC-2263XV2
.02 - 4.0	.08 - 15.0	1.3 - 250	150 (10)	½" Male NPT	MC-2246XV3	MC-2256XV3	MC-2266XV3
.02 - 4.0	.08 - 15.0	1.3 - 250	150 (10)	½" Female /NPT	MC-2246XV4	MC-2256XV4	MC-2266XV4
.02 - 4.0	.08 - 15.0	1.3 - 250	150 (10)	3/4"OD x 1/2"ID TUBE	MC-2246XV1	MC-2256XV1	MC-2266XV1
.02 - 4.0	.08 - 15.0	1.3 - 250	150 (10)	3/8"OD x 1/4"ID TUBE	MC-2246XV2	MC-2256XV2	MC-2266XV2
.05 - 10	.19 - 38	3.2 - 631	175 (12)	½" Male NPT	MC-2241XV3	MC-2251XV3	MC-2261XV3
.05 - 10	.19 - 38	3.2 - 631	175 (12)	½" Female /NPT	MC-2241XV4	MC-2251XV4	MC-2261XV4
.05 - 10	.19 - 38	3.2 - 631	175 (12)	3/4"OD x 1/2"ID TUBE	MC-2241XV1	MC-2251XV1	MC-2261XV1
.05 - 10	.19 - 38	3.2 - 631	175 (12)	3/8"OD x 1/4"ID TUBE	MC-2241XV2	MC-2251XV2	MC-2261XV2
.08 - 16.5	.31 - 62.5	8.25 - 1041	175 (12)	½" Male NPT	MC-2242XV3	MC-2252XV3	MC-2262XV3
.08 - 16.5	.31 - 62.5	8.25 - 1041	175 (12)	½" Female /NPT	MC-2242XV4	MC-2252XV4	MC-2262XV4
.08 - 16.5	.31 - 62.5	8.25 - 1041	175 (12)	3/4"OD x 1/2"ID TUBE	MC-2242XV1	MC-2252XV1	MC-2262XV1
.08 - 16.5	.31 - 62.5	8.25 - 1041	175 (12)	3/8"OD x 1/4"ID TUBE	MC-2242XV2	MC-2252XV2	MC-2262XV2

MC3 Diaphragm Metering Pump							
130 Strokes per minute							
Feed Rate Range at 0 PSIG			Max Pressure	Connection Type	MC-2 Model Numbers		
GPH	LPH	ML/MIN	PSIG (bar)	Size / Type	115V60 AC	230V60 AC	220V50 AC
.13 - 26.2	.5 - 99	8.25 - 1650	150 (10.3)	½" Male NPT	MC-3141XV3	MC-3151XV3	MC-3161XV3
.13 - 26.2	.5 - 99	8.25 - 1650	150 (10.3)	½" Female /NPT	MC-3141XV4	MC-3151XV4	MC-3161XV4
.13 - 26.2	.5 - 99	8.25 - 1650	150 (10.3)	3/4"OD x 1/2"ID TUBE	MC-3141XV1	MC-3151XV1	MC-3161XV1
.20 - 40.6	.77 - 154	12.8 - 2560	100 (6.8)	½" Male NPT	MC-3142XV3	MC-3152XV3	MC-3162XV3
.20 - 40.6	.77 - 154	12.8 - 2560	100 (6.8)	½" Female NPT	MC-3142XV4	MC-3152XV4	MC-3162XV4
.20 - 40.6	.77 - 154	12.8 - 2560	100 (6.8)	3/4"OD x 1/2"ID TUBE	MC-3142XV1	MC-3152XV1	MC-3162XV1

»CHEM-FEED® Pumps motor speed is linear over the entire 0.5% to 100% adjustment range.

»Output versus pressure is nearly linear in all models.

»Feed rates taken in laboratory environment with clean water after 20 minute diaphragm break-in period with a 3 foot (1 meter) suction lift.

2.0 Specifications

<p>Maximum working pressure*: 175 psig (12 bar), *model specific</p> <p>Maximum Fluid temperature (excluding pump tubes): 130° F (54° C)</p> <p>Maximum fluid viscosity: 1,000 Centipoise</p> <p>Maximum suction lift: 15 ft. Water, 0 psig (4.5 m, 0 bar)</p> <p>Ambient Operating Temperature 14°F to 115°F (-10°C to 46°C)</p> <p>Ambient Storage Temperature -40°F to 158°F (-40°C to 70°C)</p> <p>Operating Voltage: 115VAC/60Hz, 1ph (1.5 Amp Maximum) 230VAC/60Hz, 1ph (0.7 Amp Maximum) 220VAC/50Hz, 1ph (1.0 Amp Maximum) 240VAC/50Hz, 1ph (1.0 Amp Maximum)</p> <p>Power Cord Options: 115V60Hz = NEMA 5/15 (USA) 230V60Hz = NEMA 6/15 (USA) 220V50Hz = CEE 7/VII (EU) 240V50Hz = AS 3112 (Australia/New Zealand)</p>	<p>Motor: Brushed DC, 1/8 H.P.</p> <p>Duty cycle: Continuous</p> <p>Motor speed adjustment range 200:1: 0.5% - 100% motor speed</p> <p>Motor speed adjustment resolution: 0.1% increments</p> <p>Accuracy: +/- 2% of full scale Repeatability +/- 0.5%</p> <p>Display Backlit LCD, UV resistant.</p> <p>Keypad Five button positive action tactile switch keypad.</p> <p>Enclosure: NEMA 4X (IP66), Powder coated aluminum. Maximum overall dimensions: MC2 models: 11-3/4"W x 7-3/4"H x 10-3/4"D (298W x 197H x 274D mm) MC3 models: 13-1/8"W x 9"H x 10-3/4"D (333W x 228H x 274D mm)</p> <p>Approximate shipping wt: MC2 models: 24 lb. (10.9 Kg) MC3 models: 29 lb. (13.1 Kg)</p>
---	--

2.1 Materials of construction

<p>Wetted components:</p> <p>Pump Head Assembly: Pump Head:PVDF Adapter Connections:PVDF Prime/Degassing Valve:PVDF Valve Cartridges:PVDF Valve Balls:Ceramic Valve Ball Seats:TFE/P Tetrafluorethylene/propylene Static Seals:TFE/P (optional EP) Diaphragm:PVDF. Flex-A-Prene®</p> <p>Foot Valve / Strainer: Body & Adapter:PVDF Check Ball:Ceramic Spring:Hastelloy C-276 O-ring seals:TFE/P (optional EP) Filter screen:PVDF</p>	<p>Non-Wetted components:</p> <p>Enclosure: 413 Aluminum (Polyester powder coated)</p> <p>Pump Head Cover: 316 SS (Polyester powder coated)</p> <p>Cover Screws: 300 Series Stainless Steel</p> <p>DFD System Sensor pins: Hastelloy C-276</p> <p>Power Cord: 3 conductor, SJTW-A Water-resistant</p> <p>Mounting Brackets and Hardware: 316 Series Stainless Steel</p>
---	--

3.0 Features

Motor driven diaphragm pump offers smooth and quiet chemical dosing. No hard pulses as seen with solenoid driven pumps.

Full stroke every time avoids vapor lock.

Variable speed DC motor.

Rated for continuous duty (24X7).

Exclusive DIAFLEX® Diaphragm guaranteed to last the life of the pump.

PVDF / Ceramic pump head components.

Diaphragm Failure Detection (DFD) system. Senses diaphragm failure by detecting chemical in pump head.

Backlit LCD displays motor speed, input signal values, service and alarm status.

CNC precision machined cam and piston for optimum efficiency, unparalleled accuracy, and linearity.

Heavy duty PVDF pump head and valves are standard.

Compatible with Blue-White's output Flow Verification Sensor (FVS) system.

Includes stainless steel extended mounting brackets. Lifts pump 4-1/2" (11.43 cm), for easy access in hard to reach areas.

3.1 Agency Listings



This pump is certified to NSF/ANSI Standard 61 - Drinking Water System Components - Health Effects



Intertek

This pump is ETL listed to conform to the following:
UL Standard 778 as a motor operated water pump
CSA Standard C22.2 as process control equipment



This pump complies to the Machinery Directive 2006/42/EC, BS, EN 60204-1, Low Voltage Directive 2014/35/EU BS EN 61010-1, EMC Directive 2014/30/EU, BS EN 50081-1/BS EN 50082-1.

Symbol	Explanation
	WARNING, risk of electric shock
	CAUTION, refer to users' guide
	GROUND, PROTECTIVE CONDUCTOR TERMINAL

Enclosure Rating:

NEMA 4X: Constructed for either indoor or outdoor use to provide a degree of protection to personnel against incidental contact with enclosed equipment; to provide a degree of protection against falling dirt, rain, sleet, snow, windblown dust, splashing water, and hose-directed water; and that will be undamaged by external formation of ice on enclosure.

IP66: No ingress of dust; complete protection against contact. Water projected in powerful jets against enclosure from any direction shall have no harmful effects.

4.0 Installation

CAUTION ⚠	Risk of chemical overdose. Be certain pump does not overdose chemical during backwash and periods of no flow in circulation system.
CAUTION ⚠	Always wear protective clothing, face shield, safety glasses and gloves when working on or near your metering pump. Additional precautions should be taken depending on solution being pumped. Refer to MSDS precautions from your solution supplier.
CAUTION ⚠	All diagrams are strictly for guideline purposes only. Always consult an expert before installing metering pump on specialized systems. Metering pump should be serviced by qualified persons only.

4.1 Mounting Location

Choose an area located near chemical supply tank, chemical injection point, and electrical supply. Install pump where it can be easily serviced.

316SS Mounting brackets are included. Mount pump to a secure surface using enclosed mounting hardware.

Mount pump close to injection point. Keep inlet (suction) and outlet (discharge) plumbing as short as possible. Longer discharge plumbing increases back pressure at pump head.

Important! Install a back flow prevention check valve at discharge side of pump to prevent system fluid from flowing back through pump during pump maintenance.

A pressure relief valve is recommended at discharge of pump.

4.2 Dimensions

The image contains three technical drawings of the metering pump. The 'Top' view shows dimensions A (width), B (height), C (depth), and D (mounting bracket height). The 'Front' view shows dimensions E (width), F (height), G (total height with bracket), and I (width to discharge). The 'Right' view shows dimensions F (height) and J (width to discharge).

MC2 Dimensions			MC3 Dimensions		
Dim	Inches	cm	Dim	Inches	cm
A	14.1"	32.5	A	14.1"	35.8
B	11.5"	29.2	B	12"	30.5
C	3.7"	9.5	C	3.7"	9.5
D	2.5"	6.4	D	2.5"	6.4
E	13.1"	29.9	E	13.1"	33.2
F	7.9"	20.1	F	9"	22.9
G	7.3"	18.4	G	7.8"	19.8
H	6.5"	16.4	H	6.5"	16.4
I	15"	34.6	I	15"	38
J	8"	20.3	J	8"	20.3

Note: Included Extended Bracket adds 4.5" (11.43cm) to overall height (dimension G and H).



4.3 Foot Valve / Strainer

CAUTION Proper eye and skin protection must be worn when installing and servicing pump.

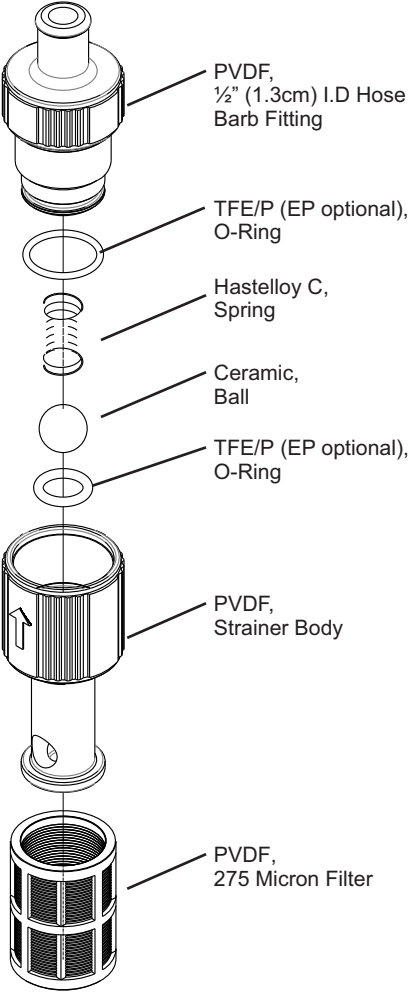
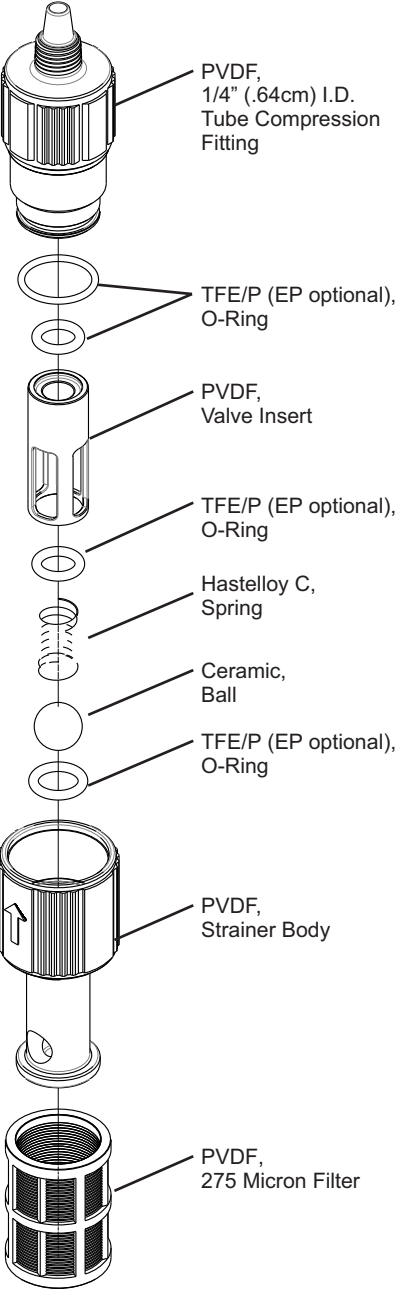
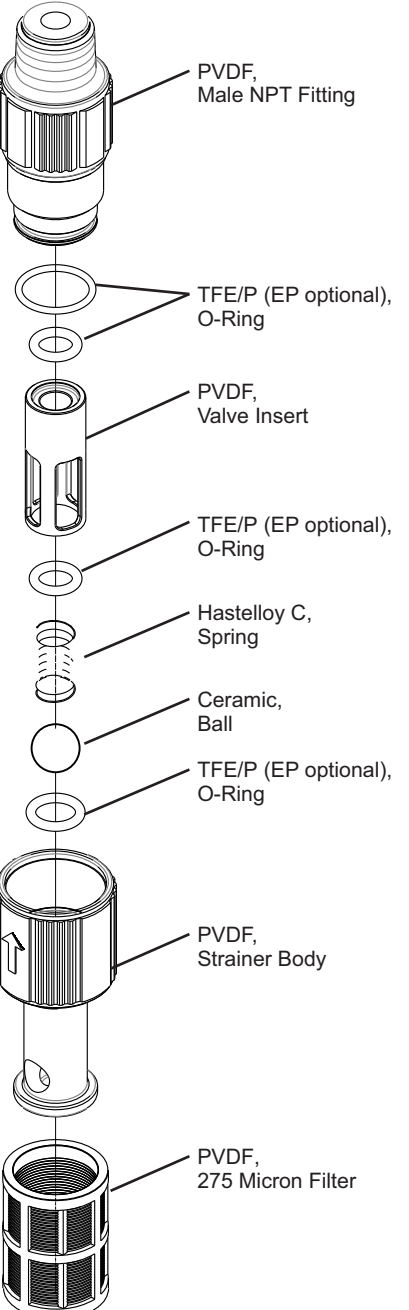
CAUTION This Pump Has Been Evaluated for Use with Water Only.

<p>1/2" (1.3cm) I.D. Hose Barb Fitting Foot valve / strainer.</p>	<p>1/4" (.64cm) I.D. Tube Compression Fitting Foot valve / strainer.</p>	<p>1/2" (1.3cm) Male NPT Foot valve / strainer.</p>
 <p>PVDF, 1/2" (1.3cm) I.D. Hose Barb Fitting</p> <p>TFE/P (EP optional), O-Ring</p> <p>Hastelloy C, Spring</p> <p>Ceramic, Ball</p> <p>TFE/P (EP optional), O-Ring</p> <p>PVDF, Strainer Body</p> <p>PVDF, 275 Micron Filter</p>	 <p>PVDF, 1/4" (.64cm) I.D. Tube Compression Fitting</p> <p>TFE/P (EP optional), O-Ring</p> <p>PVDF, Valve Insert</p> <p>TFE/P (EP optional), O-Ring</p> <p>Hastelloy C, Spring</p> <p>Ceramic, Ball</p> <p>TFE/P (EP optional), O-Ring</p> <p>PVDF, Strainer Body</p> <p>PVDF, 275 Micron Filter</p>	 <p>PVDF, Male NPT Fitting</p> <p>TFE/P (EP optional), O-Ring</p> <p>PVDF, Valve Insert</p> <p>TFE/P (EP optional), O-Ring</p> <p>Hastelloy C, Spring</p> <p>Ceramic, Ball</p> <p>TFE/P (EP optional), O-Ring</p> <p>PVDF, Strainer Body</p> <p>PVDF, 275 Micron Filter</p>
<p>Part Numbers: 71000-575 - 1/2" Barb valve, Viton 71000-576 - 1/2" Barb valve, EP</p>	<p>Part Numbers: 71001-005 - 1/4" ID Tube, Viton 71001-006 - 1/4" ID Tube, EP</p>	<p>Part Numbers: 71000-849 - 1/2" M/ NPT valve, Viton 71000-850 - 1/2" M/NPT valve, EP</p>

5.0 Power Connections

WARNING 	Risk of electric shock – cord connected models are supplied with a grounding conductor and grounding-type attachment plug. To reduce risk of electric shock, be certain that it is connected only to a properly grounded, grounding-type receptacle.
WARNING 	Electrical connections and grounding (earthing) must conform to local wiring codes. Be certain that a grounding conductor is connected to terminal T11-1 located in wiring compartment.
WARNING 	Risk of electric shock - Disconnect electricity before removing wiring compartment cover.

Be certain to connect pump to proper supply voltage. Using incorrect voltage will damage pump and may result in injury. Voltage requirement is printed on pump serial label.

Input power: 115VAC 50/60 Hz 1.5 amp or 230/240VAC 50/60 Hz 0.7 amp.

Power switch located in Junction Box.

Use voltage your power cord is rated for.

Cord connected models are supplied with a ground wire conductor and a grounding type attachment plug (power cord). To reduce risk of electric shock, be certain that power cord is connected only to a properly grounded, grounding type receptacle.

Permanently connected models must be properly grounded. Be certain that a grounding conductor is connected to terminal T11-1 located in wiring compartment.

Never strap control (input / output) cables and power cables together.

Power Interruption: This pump has an auto-restart feature which will restore pump to operating state it was in prior to power loss.

Note: When in doubt regarding your electrical installation, contact a licensed electrician.

WIRING COMPARTMENT COVER

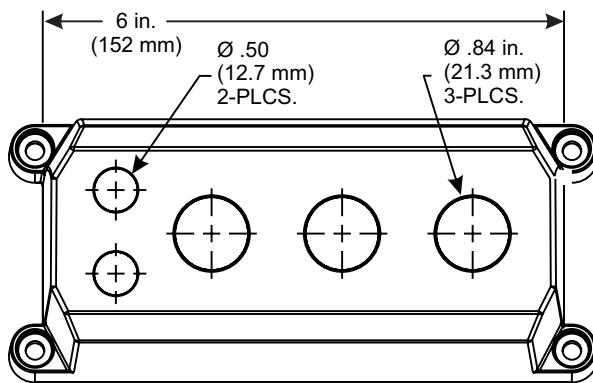

POWER CORD OPTIONS

Four power cord plug types available. Power cord length is 6 feet (3.83 meters)



115V 60Hz NEMA 5/15 (USA) max: 125V AC
 230V 60Hz NEMA 6/15 (USA) max: 250V AC
 240V 50Hz CEE 7/VII (EU) max: 250V AC

Included cable and conduit connectors:

QTY.	DESCRIPTION
Qty: 2	.50 Inch (12.7 Mm) Liq-tight Hole Plugs (mat'l = Neoprene), Pre-installed
Qty: 3	.875 Inch (22.2 Mm) Liq-tight Hole Plugs (mat'l = Neoprene), 2 Pre-installed
Qty: 2	.50 Inch (12.7 Mm) Liq-tight Connectors For Pass Thru Cords (mat'l = Nylon) Acceptable Cable Diameter .12 To .26 Inch (3.0 To 6.5 Mm), Not Installed
Qty: 3	.875 Inch (22.2 Mm) Liq-tight Connectors For Pass Thru Cords (mat'l = Nylon) Acceptable Cable Diameter .20 To .40 Inch (5.1 To =10.0 Mm), 1 Pre-installed W/ Power Cord Models
Qty: 2	Metallic Liq-tight Connectors For .50 Inch Flexible Conduit (mat'l = Die Cast Zinc), Not Installed

5.1 Wiring Terminals and I/O Schematics

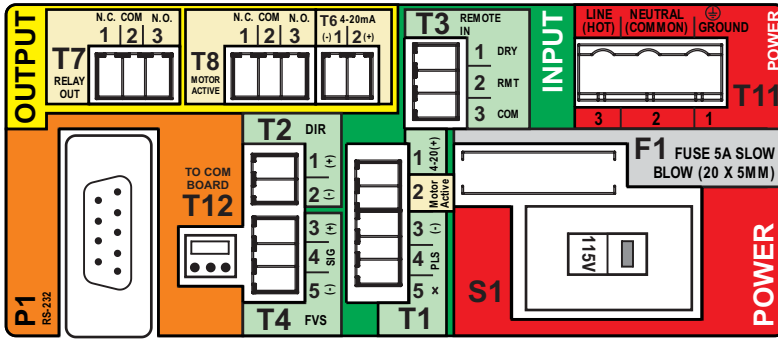

WARNING Risk of electric shock - All wiring must be insulated and rated 300V minimum.

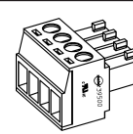

Terminals T1 Thru T8
Plug type
16 - 24 AWG

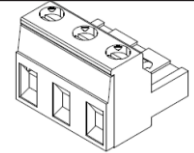

Power Input Terminal T11
Plug type
14 - 30 AWG

Shielded cables should be used on all input signal wires.

FUNCTION	TERM	PIN #	RATING	ELECTRICAL SP.	BLOCK DIAGRAM
INPUT: 4-20 mA	T1	1	(+) POSITIVE	120 OHM IMPEDANCE, NON POWERED LOOP	<p>Single or dual pump (series) input. Loop voltage must be a minimum of 15V, and not exceed 24 Volts.</p>
	T1	3	(-) NEGATIVE		
INPUT: FREQUENCY, AC SINE WAVE, TTL, CMOS	T1	3	(-) NEGATIVE	0-1000 HZ MAX.	
	T1	4	(+) POSITIVE		
INPUT: FVS SYSTEM (FLOW VERIFICATION SENSOR) FV SENSOR ONLY	T4	3	(+) POSITIVE		
	T4	4	SIGNAL		
	T4	5	(-) NEGATIVE		
INPUT: FVS SYSTEM (FLOW VERIFICATION SENSOR) MS6 FLOW METER ONLY	T4	4	SIGNAL		
	T4	5	(-) NEGATIVE		
	T4	5	(-) NEGATIVE		
INPUT: REMOTE START / STOP (DRY CONTACT C.)	T3	1	(+) POSITIVE	NO VOLTAGE	<p>NOTE: USE ONLY DRY CONTACT FOR REMOTE S/S WHEN USING 4-20mA INPUT</p>
	T3	2	(-) NEGATIVE		
INPUT: REMOTE START / STOP (WET CONTACT C.)	T3	2	(+) POSITIVE	6 TO 30 VOLT DC 1 AMP MAX.	
	T3	3	(-) NEGATIVE		
OUTPUT: 4-20 mA	T6	2	(+) POSITIVE	120 OHM RESISTANCE ACTIVE LOOP	
	T6	1	(-) NEGATIVE		
OUTPUT: RELAY, 3 AMP (Triggers with DFD, or FVS, if enabled)	T7	1	NORM. CLOSED	Form C 3 AMP MAX AT 250 VAC, 3 AMP MAX AT 30 VOLT DC	
	T7	2	COMMON		
	T7	3	NORM. OPEN		
OUTPUT: OPEN COLLECTOR MOTOR ACTIVE	T1	2	SIGNAL	5 TO 24 VDC	<p>CLOSED WHILE MOTOR IS ENERGIZED</p>
	T1	3	COMMON		
OUTPUT: MOTOR ACTIVE (CONTACT CLOSURE)	T8	1	NORM. CLOSED	Form C 1 AMP MAX AT 125 VAC, 0.8 AMP MAX AT 30 VOLT DC	
	T8	2	COMMON		
	T8	3	NORM. OPEN		
INPUT: POWER	T11	1	GROUND	115V OR 230V AC MANUAL SWITCH 50 / 60 HZ 100W	
	T11	2	NEUTRAL		
	T11	3	LINE (HOT)		
FUSE	F1	N/A	5 AMP	5A SLOW BLOW (20 X 5MM)	

6.0 How to Operate CHEM-FEED® - Control Pad

 **MODE**

Press and Release while pump is stopped
To select Run Mode

- Mode 1: Manual
- Mode 2: 4-20mA input
- Mode 3: Frequency input
- Mode 4: Pulse / Batch



Press and Hold while pump is stopped
To configure selected Mode

- Mode 0: Setup
- Mode 1: Manual
- Mode 2: 4-20mA input
- Mode 3: Frequency input
- Mode 4: Pulse / Batch

Press and Release while pump is running
To display:

- Displays: Motor Speed (0.5 - 100%)
- Displays: Flow Rate (if configured)
- Displays: 4-20 mA input (if configured)
- Displays: 4-20 mA output (if configured)





 **Press and release**
To prime pump (60 seconds)
Press  at any time to Stop Prime

 **Press and release**
Press UP arrow to increase pump speed (output) in Manual Operation.
To increase value while in programming mode.

 **Press and release**
To Stop pump at any time.

Press and release
To Start pump.
To begin listening (reacting) to external signal, such as Remote Start/Stop.

 **Press and release**
Press DOWN arrow to decrease pump speed (output) in Manual Operation.
To decrease value while in programming mode.

 **Press and hold (while pump is OFF)**
To enter Setup / programming mode.

- Remote Start/Stop, FVS, DFD, 4-20mA Out
- Flow rate units, Max Flowrate at 100% flow

Press and release
To save setting while in programming mode.
To move to **next** selection while in programming mode.

Time-out - CHEM-FEED® pumps have a time-out setting of approximately 20 seconds while in configuration menu. If built-in timer exceeds 20 seconds without a button being pressed, then pump will exit configuration menu. Changes will automatically be saved if programming mode is allowed to Time-Out.

6.1 Mode Descriptions

Mode 0 - Setup

Press and Hold while pump is stopped to configure:

- Remote Start / Stop
- DFD (Diaphragm Failure Detection) sensitivity
- FVS (Flow Verification Sensor) time delay - requires sensor
- 4-20 mA output
- rATE (displays pump output flow rate)
- fLOW mAX setting (flowrate at 100%, scales to display flowrate when running)

Mode 0



Mode 1 - Manual

Run pump locally by selecting pump speed (0.5 - 100%).

- Control speed by using up or down arrows after start button is pressed.
- Control speed by entering Mode 1 setup and selecting desired pump speed (0.5 - 100%)

Mode 1

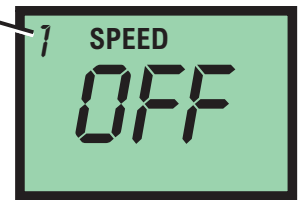

Mode 2 - 4-20 mA Input Signal

Run pump remotely via external 4-20 mA signal.

- Press and Hold "MODE" button with Mode 2 selected to configure settings.
- Select Mode 2 and press START button to allow pump to be controlled by external 4-20mA signal.

Mode 2

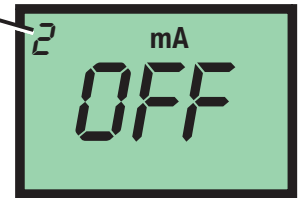

Mode 3 - Frequency (Hz) Input Signal

Run pump remotely via external high frequency (Hz) signal.

- Press and Hold "MODE" button with Mode 3 selected to configure settings.
- Select Mode 3 and press START button to allow pump to be controlled by external frequency (Hz) signal.

Mode 3

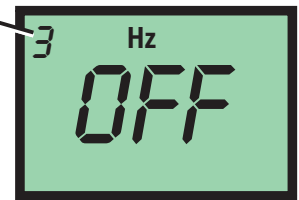

Mode 4 - Pulse Batch Input Signal (low speed pulse)

Run pump remotely via external low speed pulse signal.

- Press and Hold "MODE" button with Mode 4 selected to configure settings.
- Select Mode 4 and press START button to allow pump to be controlled by external low speed pulse signal.

Mode 4

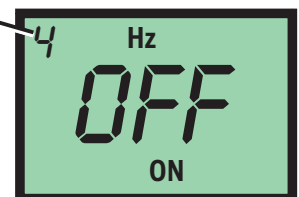

7.0 Mode 0 - Set Remote Start / Stop

Used to remotely start and stop pump using a dry contact closure signal.
When activated; CLOSE = START and OPEN = STOP.

Set to NO = Remote Start / Stop is disabled
Set to Yes = Remote Start / Stop is enabled

Can be used with external foot pedal, PLC, contact closure or other similar external devices.

Default setting = No (disabled)

Step 1

Ensure pump is stopped and LCD reads "OFF."

Note: Mode cannot be changed while pump is in running.

Press and release STOP button if pump is running.

Press and release MODE button multiple times until Mode 0 is selected.

Mode 0



Step 2

With Mode 0 selected, press and hold MODE button until 'Remote' icon begins flashing.

Default setting 'NO' will also be visible when entering remote start / stop setup.

Note: If 'YES' had been selected previously, then 'YES' will be displayed on screen.

Mode 0

Remote Icon

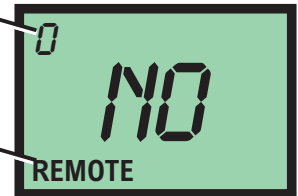

Step 3

Press and release DOWN arrow to change setting to 'YES.'

To change setting back to 'NO' press and release UP arrow.

Mode 0



Step 4

After you've made your selection, press and release MODE button. This saves your setting.

You can now modify other settings in Mode 0 or you can exit Setup by pressing and holding MODE button for a few seconds until you return to Run screen.

Mode 0



Running pump with Remote Start / Stop enabled, 'REMOTE' icon will always be visible on lower left side of screen. Pump will display 'STBY' (standby) if pump is in stop mode via contact closure signal. **Please use caution in this mode, pump can start at anytime. If you must perform maintenance to pump, press and release STOP button.**

7.1 Mode 0 - Set DFD Sensitivity

CHEM-FEED pump is equipped with a Diaphragm Failure Detection (DFD) system which is designed to stop pump in event diaphragm should rupture and chemical enters pump head. This system is capable of detection presence of a large number of chemicals including Sodium Hypochlorite (chlorine), Hydrochloric (muriatic) Acid, Sodium Hydroxide, and many others.

Minimum and Maximum setting = 75 % to 100%

Default Setting = 75% (75% is recommended; triggers with most water treatment chemicals without false alarms)

Important: 100% sensitivity setting may trigger false alarm by washdown or rain. 100% setting is only recommended when absolutely necessary.

Step 1

Ensure pump is stopped and LCD reads "OFF."

Note: Mode cannot be changed while pump is in running.

Press and release STOP button if pump is running.

Press and release MODE button multiple times until Mode 0 is selected.

Mode 0



Step 2

With Mode 0 selected, press and hold MODE button until 'Remote' icon begins flashing.

This indicates that you've entered Setup menu.

Mode 0

Remote
Icon



Step 3

Press and release MODE button to scroll through menu until you see DFD icon.

If you pass DFD screen, continue to press and release MODE button until TFD icon appears.

Mode 0



Step 4

DFD icon will appear for 1 second, followed by numbers.

Numbers indicate sensitivity value of DFD.

Press and release UP arrow button to increase sensitivity value.

Press and release DOWN arrow button to decrease sensitivity value.

Mode 0



Step 5

After you've made your selection, press and release MODE button. This saves your setting.

You can now modify other settings in Mode 0 or you can exit Setup by; press and hold MODE button for a few seconds until you return to Run screen.

Mode 0



7.2 Mode 0 - Set FVS (Flow Verification System)

Flow verification sensor sold separately.

Flow verification system is designed to stop pump in an event sensor does not detect flow during pump operation. Indicating an empty chemical tank, clogged injection fitting, loose tubing connection, etc.

To allow pump to clear any gasses that may have accumulated over time, an alarm delay time value from 1 to 255 seconds must be programmed.

Note: An alarm delay of 000 seconds disables FVS system.

Step 1

Ensure pump is stopped and LCD reads "OFF."

Note: Mode cannot be changed while pump is in running.

Press and release STOP button if pump is running.

Press and release MODE button multiple times until Mode 0 is selected.

Mode 0



Step 2

With Mode 0 selected, press and hold MODE button until 'Remote' icon begins flashing.

This indicates that you've entered Setup menu.

Mode 0

Remote
Icon



Step 3

Press and release MODE button to scroll through menu until you see FVS icon.

If you pass FVS screen, continue to press and release MODE button until FVS icon appears.

Mode 0



Step 4

FVS icon will appear for 1 second, followed by numbers.

These numbers indicate delay time setting for FVS.

Select a delay time in seconds. Delay time is amount of time pump will wait to receive a pulse from sensor until an alarm it triggered.

A delay time of 00 deactivates FVS feature.

Mode 0

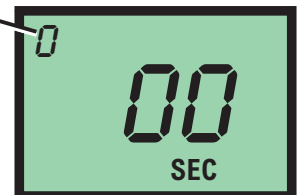

Step 5

After you've made your selection, press and release MODE button. This saves your setting.

You can now modify other settings in Mode 0 or you can exit Setup by; press and hold MODE button for a few seconds until you return to Run screen.

Mode 0



Time-out - CHEM-FEED® pumps have a time-out setting of approximately 20 seconds while in configuration menu. If built-in timer exceeds 20 seconds without a button being pressed, then pump will exit configuration menu. Changes will automatically be saved if programming mode is allowed to Time-Out.

7.2 Mode 0 - Set FVS (Flow Verification System) - Continued

Flow Verification Sensors are designed to give you installation options.

MS6 Flow Sensor or Micro-Flo can be used with FVS System.

Sensor can be installed:

- Directly onto pump head of CHEM-FEED® pump, discharge side (MicroFlo only)
- discharge side of CHEM-FEED® pump, as directed by Micro-Flo and Ms6 manuals.

Wiring for sensor can be connected directly to a CHEM-FEED® pump. Pump will stop pumping if sensor detects no flow. A relay will then close allowing for remote alarm indication or initiation of a back-up pump.

When installing MicroFlo directly onto pump 3/8" tube discharge fitting:

MixroFlo Sensor includes a PVC tubing insert, located inside sensors female thread connection, that is designed to seal sensor onto pump tube adapter. Thread sensor onto pump tube until tubing insert is snug against pump tube fitting - do not over-tighten.

Sensor Model Number	Published Flow Range	Actual Working Range with CHEM-FEED® Pump
	ML/Min	ML/Min
FV-100	30-300	30-200
FV-200	100-1000	50-900
FV-300	200-2000	100-1800
FV-400	300-3000	300-3000
FV-500	500-5000	500-5000
FV-600	700-7000	700-7000
MS61	10-5000	10-5000
MS62	50-10000	50-10000

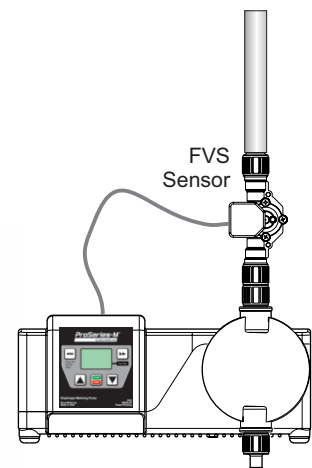
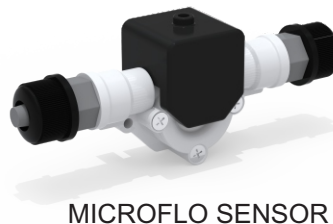

Confirm FVS flow range - Flow Verification Sensor (FVS) will only function within its operating range. See chart for available ranges.

NOTE: If pump output is less than minimum range, sensor will not detect chemical and a signal will not be sent to pump, resulting in an alarm condition.

NOTE: For low viscosity (water-like) fluids only. Consult factory if attempting to use with viscous fluids.

7.3 Mode 0 - Set 4-20mA Output

Sends a configurable 4-20 mA signal, based on pump rotor speed, to an external device. This feature can be used to control other pumps (in sync / proportionally), data logging systems, and other external devices for plant automation.

Default setting: Minimum Speed = 4 mA signal output
Maximum Speed = 20 mA signal output

Set to NO = disabled
Set to Yes = enabled

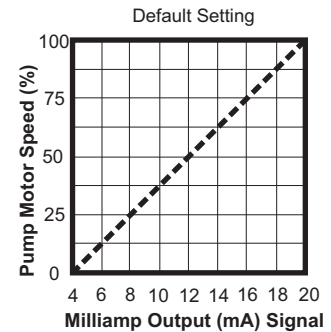

Step 1

Ensure pump is stopped and LCD reads "OFF."

Note: Mode cannot be changed while pump is in running.

Press and release STOP button if pump is running.

Press and release MODE button multiple times until Mode 0 is selected.

Mode 0



Step 2

With Mode 0 selected, press and hold MODE button until 'Remote' icon begins flashing.

This indicates that you've entered Setup menu.

Mode 0

Remote Icon



Step 3

Press and release MODE button to scroll through menu until you see 4-20 mA icon.

To select Yes, press and release DOWN arrow.

To select No, press and release UP arrow.

To begin configuring values, select Yes.

Then press and release MODE button.

Mode 0

4-20 mA Icon

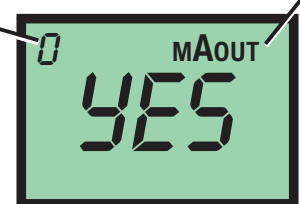

Step 4

Minimum pump speed will be displayed.

To increase value, press and release UP arrow.

To decrease value, press and release DOWN arrow.

To save value, press and release MODE button.

Mode 0

4-20 mA Icon

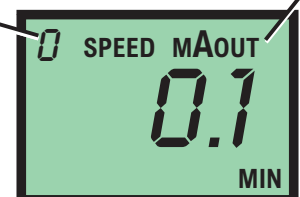

Time-out - CHEM-FEED® pumps have a time-out setting of approximately 20 seconds while in configuration menu. If built-in timer exceeds 20 seconds without a button being pressed, then pump will exit configuration menu. Changes will automatically be saved if programming mode is allowed to Time-Out.

7.3 Mode 0 - Set 4-20mA Output - Continued

Step 5

Output signal at minimum speed will now be displayed.
 To increase value, press and release UP arrow.
 To decrease value, press and release DOWN arrow.
 To save value, press and release MODE button.

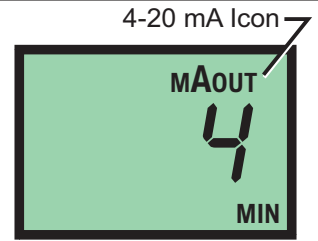

Step 6

Maximum pump speed will be displayed.
 To increase value, press and release UP arrow.
 To decrease value, press and release DOWN arrow.
 To save value, press and release MODE button.

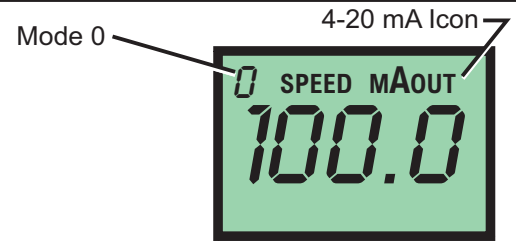

Step 7

Output signal at maximum speed will now be displayed.
 To increase value, press and release UP arrow.
 To decrease value, press and release DOWN arrow.
 To save value, press and release MODE button.

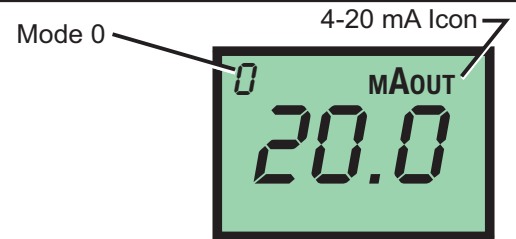

Step 8

You can now modify other settings in Mode 0 or you can exit Setup by; press and hold MODE button for a few seconds until you return to Run screen.

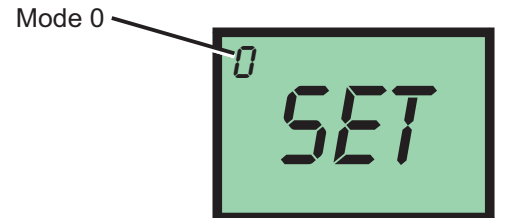

Example 1

0% Pump Output = 4 mA
 100 % Pump Output = 20 mA

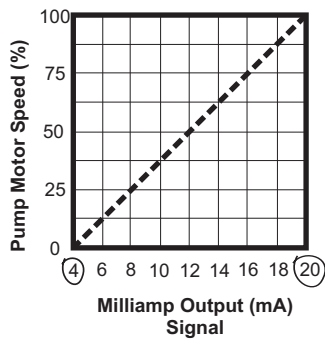

Example 2

0% Pump Output = 4 mA
 50% Pump Output = 16 mA

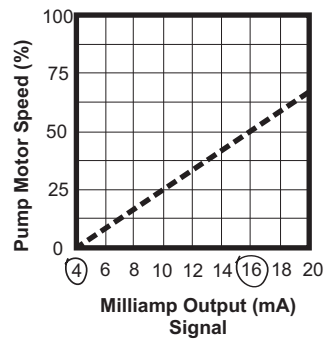

7.4 Mode 0 - Set Flow Rate Display

Display pump output Flow Rate. Default setting: mL/m (Milliliter per minute)

Available settings: none, mL/m, Oz/m, L/h, G/h

Before you begin configuring your Flow Rate, please perform a volumetric test on your pump. Please see section 13.0 Volumetric Test - Calibration

Log your Flow Rate using Milliliters Per Minute here _____ mL/m. (at 100% speed.)

Step 1

Ensure pump is stopped and LCD reads "OFF."

Note: Mode cannot be changed while pump is in running.

Press and release STOP button if pump is running.

Press and release MODE button multiple times until Mode 0 is selected.

Mode 0



Step 2

With Mode 0 selected, press and hold MODE button until 'Remote' icon begins flashing.

This indicates that you've entered Setup menu.

Mode 0

Remote
Icon



Step 3

Press and release MODE button to scroll through menu until you see RATE display for 2 seconds.

Arrow pointing at Flow Rate will begin flashing.

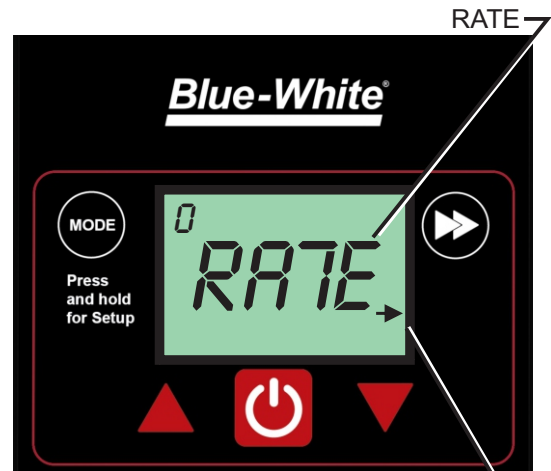

Flow Rate Arrow

Step 4

Press and release UP button or DOWN button to scroll through Flow Rate units.

Available Flow Rate units:

- None, mL/m, Oz/m, L/h, G/h

Select desired Flow Rate unit. Then press and release MODE button to save selection.

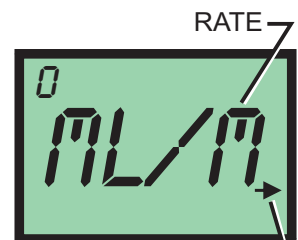

Flow Rate Arrow

7.4 Mode 0 - Set Flow Rate Display - Continued

Step 5

LCD will flash "MAX" then "FLO" then "mL/m" (or your selected Flow Rate unit), each for 2 seconds.

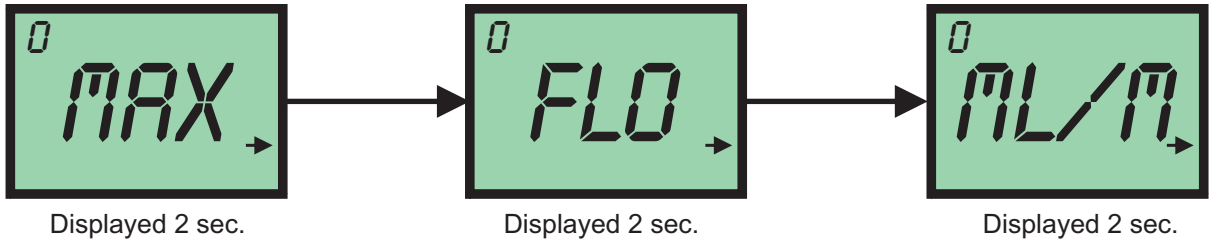

Step 6

LCD will show four digits (default is 2650 mL/m).
 Use this screen to input maximum Flow Rate for your pump in Milliliters Per Minute. (100% speed)
 To increase value, press and release UP arrow.
 To decrease value, press and release DOWN arrow.
 To save value, press and release MODE button.



Default: 2650 mL/m

Important Note: At this step, you are going to input your pumps max Flow Rate in mL/m. While pump is in normal operation, Flow Rate unit you've selected in Step 4 will be displayed on LCD.

Step 7

You can now modify other settings in Mode 0 or you can exit Setup by; press and hold MODE button for a few seconds until you return to Run screen.

Mode 0



7.4.1 Operation Screens Displaying Flow Rate

Runtime Screen Shot 1

While pump is running, press and release MODE button repeatedly until Flow Rate arrow is displayed pointing at Flow Rate.

LCD will automatically scroll (loop) between actual Flow Rate and units of measure.

Flow value displayed for 4 seconds.
 Units of measure displayed for 2.5 seconds.

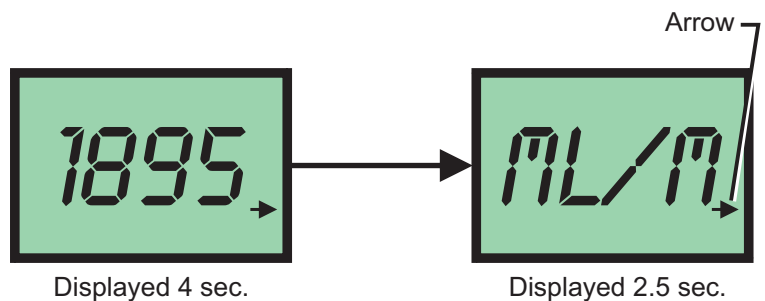

8.0 Mode 1 - Manual Operation

Used to manually control speed of pump.

Use UP and DOWN arrows to adjust speed while pump is running.

To select exact run speed, follow steps below.

Step 1

Ensure pump is stopped and LCD reads "OFF."

Note: Mode cannot be changed while pump is in running.

Press and release STOP button if pump is running.

Press and release MODE button multiple times until Mode 1 is selected.

Mode 1

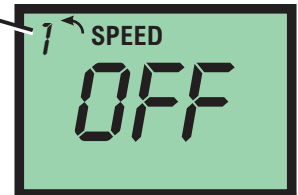

Step 2

With Mode 1 selected, press and hold MODE button until 'Speed' icon begins flashing.

This indicates that you've entered Setup menu.

Mode 1



Step 3

Current pump speed will be displayed.

To increase value, press and release UP arrow.

To decrease value, press and release DOWN arrow.

To save value, press and hold MODE button until 'Speed' icon stop flashing.

Mode 1



Step 4

Pump will now operate at your pre-configured speed.

Press and release START button to start pump.

Press and release STOP button at anytime to stop pump.

Mode 1

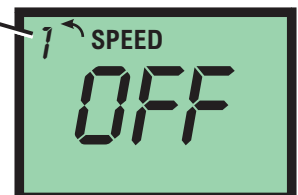

With pump operating in manual mode (Mode 1), pump speed can be changed at anytime by using UP or DOWN arrows during operation.

8.1 Mode 1 - Manual Operation Screen Shots

Runtime Screen Shot 1

Display motor speed percentage.
Pump Running in Manual Operation

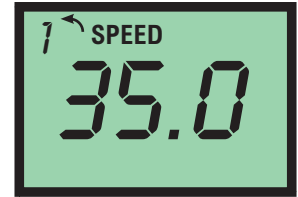

Runtime Screen Shot 2

Display 4-20mA output (select models only)
Press and release MODE button to view mA output value
in real-time.

Please note: 4-20mA output is only available on select models. If included in
your model; 4-20mA output must be enabled in Mode 0 (see page 16).

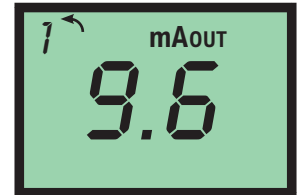

Runtime Screen Shot 3

Display motor speed percentage.
Press and release MODE button to view percentage of
motor speed.



9.0 Mode 2 - 4-20mA Input Operation

Used to remotely control pump with an incoming 4-20 mA signal.

Default setting: 4 mA signal = 0.1% motor speed
20 mA signal = 100.0% motor speed

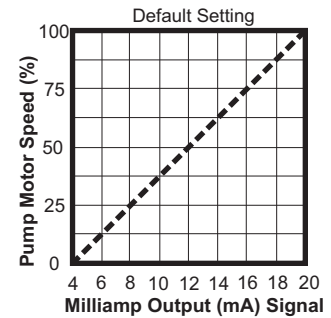

Step 1

Ensure pump is stopped and LCD reads "OFF."

Note: Mode cannot be changed while pump is in running.

Press and release STOP button if pump is running.

Press and release MODE button multiple times until Mode 2 is selected.

Mode 2

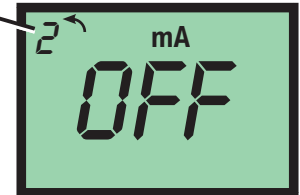

Step 2

With Mode 2 selected, press and hold MODE button until 'Speed' icon begins flashing.

This indicates that you've entered Setup menu.

Mode 2

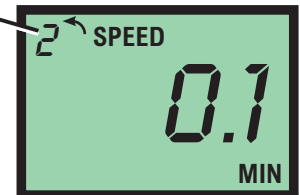

Step 3

Minimum pump speed will be displayed.

To increase value, press and release UP arrow.

To decrease value, press and release DOWN arrow.

To save value, press and release MODE button.

Mode 2

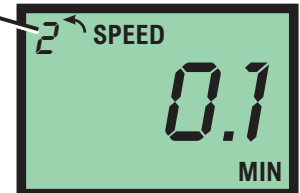

Step 4

mA value linked to minimum pump speed will be displayed.

To increase value, press and release UP arrow.

To decrease value, press and release DOWN arrow.

To save value, press and release MODE button.

Mode 2

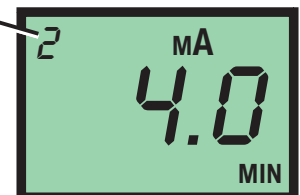

Step 5

Maximum pump speed will be displayed.

To increase value, press and release UP arrow.

To decrease value, press and release DOWN arrow.

To save value, press and release MODE button.

Mode 2



Time-out - CHEM-FEED® pumps have a time-out setting of approximately 20 seconds while in configuration menu. If built-in timer exceeds 20 seconds without a button being pressed, then pump will exit configuration menu. Changes will automatically be saved if programming mode is allowed to Time-Out.

9.0 Mode 2 - 4-20mA Input Operation - Continued

Step 6

mA value linked to minimum pump speed will now be displayed.
 To increase value, press and release UP arrow.
 To decrease value, press and release DOWN arrow.
 To save value, press and release MODE button.

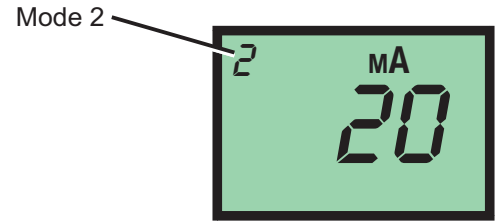

Step 7

To exit Setup, press and hold MODE button for a few seconds until you return to Run screen.

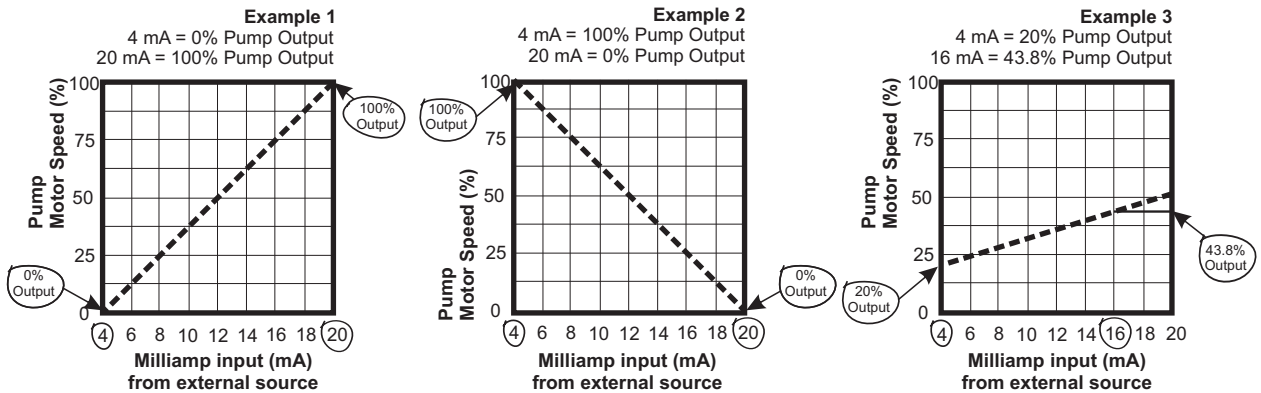
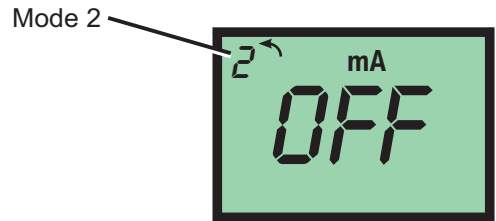

9.1 Mode 2 - 4-20mA Input Screen Shots

Runtime Screen Shot 1

Display **motor speed percentage**.
 Pump Running in 4-20mA Input Operation

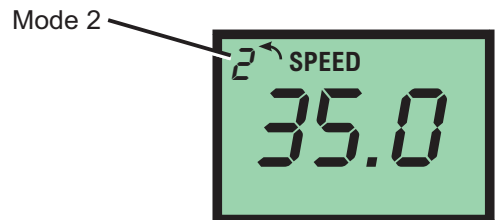

Runtime Screen Shot 2

Display current 4-20mA input signal
 Press and release MODE button to view **mA input** value in real-time.

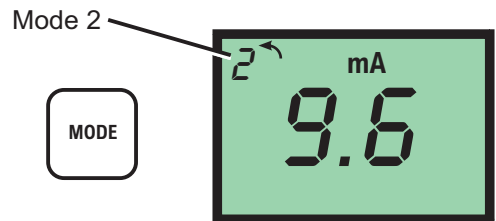

Runtime Screen Shot 3

Press and release MODE button again to view **mA output** value in real-time (available on select models only).
 Press and release MODE button again to view **motor speed percentage**, as in Screen Shot 1.

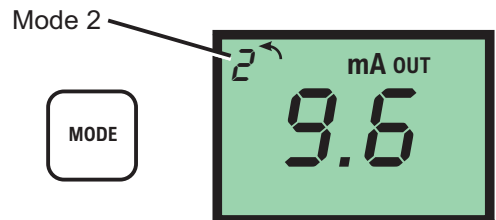

10.0 Mode 3 - Frequency Input (Hz) Operation

Used to remotely control pump with an incoming high speed frequency signal. Typically used with flow meters or other external devices.

Default setting: 0 Frequency (Hz) = 0% motor speed
1000 Frequency (Hz) = 100% motor speed

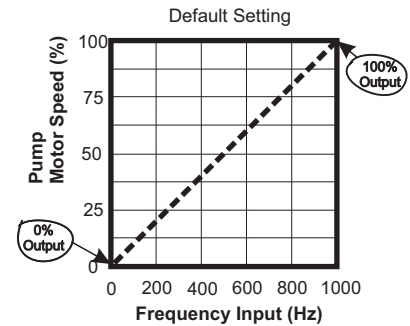

Step 1

Ensure pump is stopped and LCD reads "OFF."

Note: Mode cannot be changed while pump is in running.

Press and release STOP button if pump is running.

Press and release MODE button multiple times until Mode 3 is selected.

Mode 3

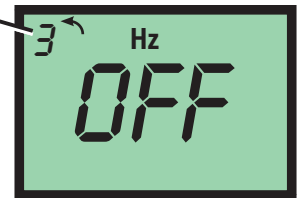

Step 2

With Mode 3 selected, press and hold MODE button until 'Speed' icon begins flashing.

This indicates that you've entered Setup menu.

Mode 3

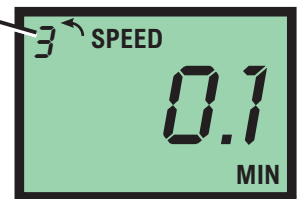

Step 3

Pump speed at minimum Frequency will be displayed.

To increase value, press and release UP arrow.

To decrease value, press and release DOWN arrow.

To save value, press and release MODE button.

Mode 3

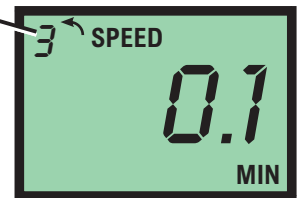

Step 4

Minimum Frequency (Hz) value will be displayed.

To increase value, press and release UP arrow.

To decrease value, press and release DOWN arrow.

To save value, press and release MODE button.

Mode 3

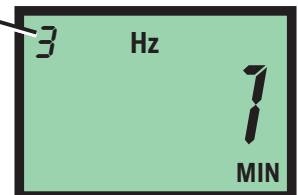

Time-out - CHEM-FEED® pumps have a time-out setting of approximately 20 seconds while in configuration menu. If built-in timer exceeds 20 seconds without a button being pressed, then pump will exit configuration menu. Changes will automatically be saved if programming mode is allowed to Time-Out.

10.0 Mode 3 - Frequency Input (Hz) Operation - Continued

Step 5

Pump speed at maximum Frequency will be displayed.
 To increase value, press and release UP arrow.
 To decrease value, press and release DOWN arrow.
 To save value, press and release MODE button.

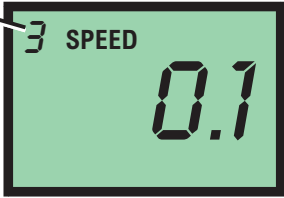

Mode 3

Step 6

Maximum Frequency value will now be displayed.
 To increase value, press and release UP arrow.
 To decrease value, press and release DOWN arrow.
 To save value, press and release MODE button.



Mode 3

Step 7

To exit Setup, press and hold MODE button for a few seconds until you return to Run screen.



Mode 3

Examples:

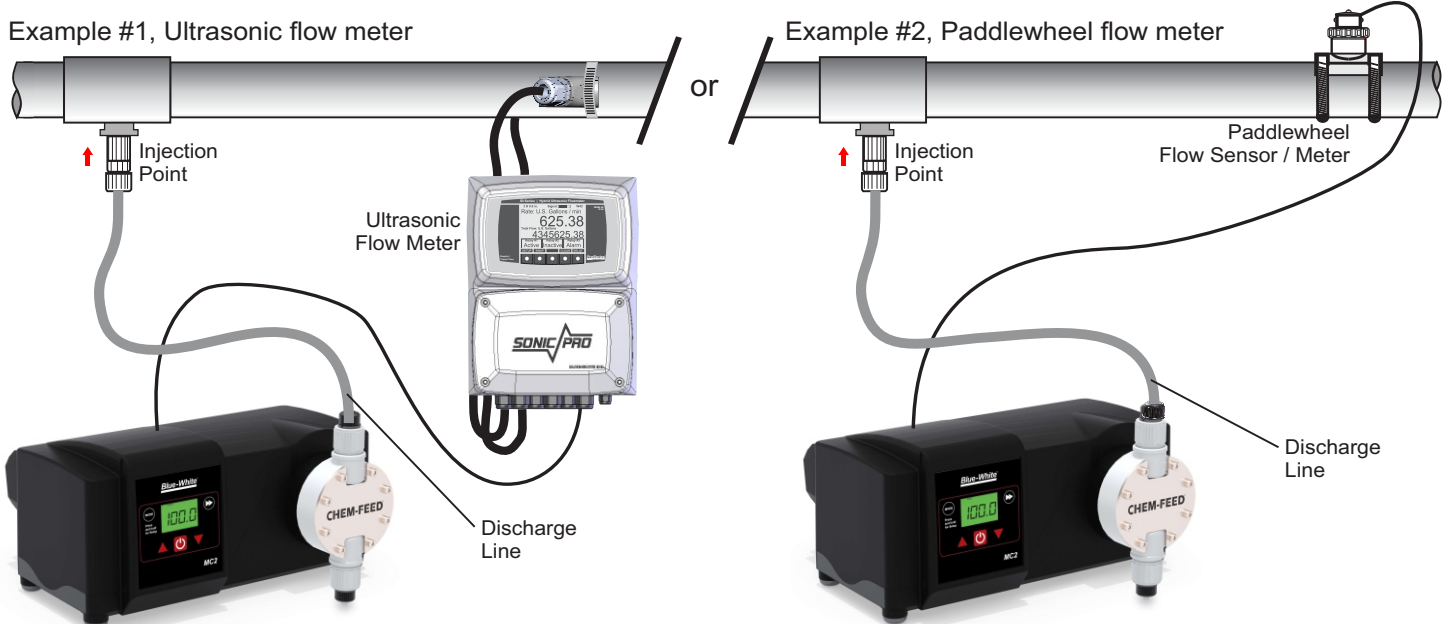
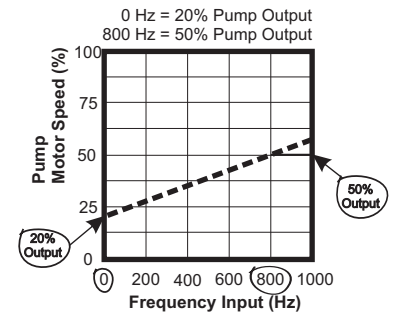
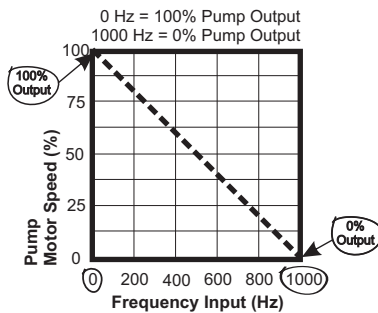
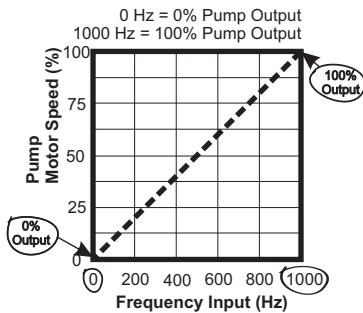

11.0 Mode 4 - Pulse Batch (low speed pulse) Operation

Used to remotely control pump with an incoming pulse signal. Can be used with an external foot pedal, a water meter, a PLC, contact closure, or other low speed pulse devices.

Default setting: 1 Pulse = 100% motor speed for 2.5 seconds

Step 1

Ensure pump is stopped and LCD reads "OFF."

Note: Mode cannot be changed while pump is in running.

Press and release STOP button if pump is running.

Press and release MODE button multiple times until Mode 4 is selected.

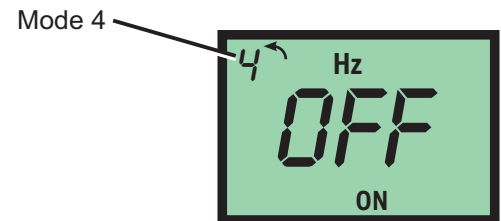

Step 2

With Mode 4 selected, press and hold MODE button until 'On' icon begins flashing.

This indicates that you've entered Setup menu.

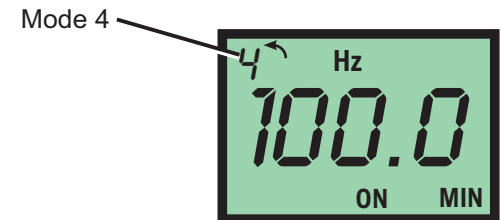

Step 3

Pump on-time will be displayed in either MIN (minutes) or SEC (seconds).

To increase value, press and release UP arrow.

To decrease value, press and release DOWN arrow.

To save value, press and release MODE button.

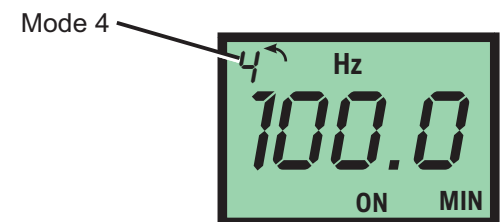

Step 4

MIN (minutes) or SEC (seconds) will be displayed in lower right hand corner. This value will be linked to Pump on-time number in previous screen.

To change this setting, press and release either UP arrow or DOWN arrow.

To save value, press and release MODE button.

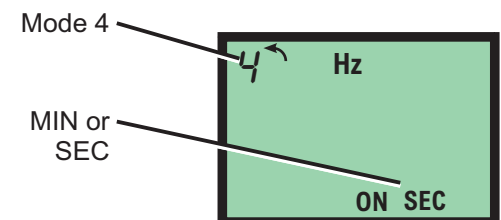

Time-out - CHEM-FEED® pumps have a time-out setting of approximately 20 seconds while in configuration menu. If built-in timer exceeds 20 seconds without a button being pressed, then pump will exit configuration menu. Changes will automatically be saved if programming mode is allowed to Time-Out.

11.0 Mode 4 - Pulse Batch (low speed pulse) Operation - Continued

Step 5

Number of pulses to trigger pump start will be displayed.
 To increase value, press and release UP arrow.
 To decrease value, press and release DOWN arrow.
 To save value, press and release MODE button.

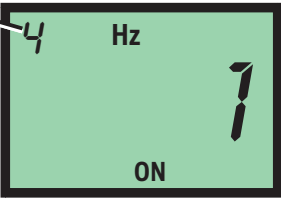

A screenshot of a green LCD screen. In the top left corner, the number '4' is displayed with a small arrow pointing to it from the label 'Mode 4'. To the right of '4' is the text 'Hz'. In the bottom right corner, the number '7' is displayed. At the bottom center, the text 'ON' is displayed.

Step 6

Pump speed during on-time will now be displayed.
 Pump will run at this speed after selected number of pulses is reached from previous menu.
 To increase value, press and release UP arrow.
 To decrease value, press and release DOWN arrow.
 To save value, press and release MODE button.

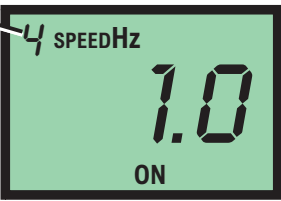

A screenshot of a green LCD screen. In the top left corner, the number '4' is displayed with a small arrow pointing to it from the label 'Mode 4'. To the right of '4' is the text 'SPEEDHz'. In the bottom right corner, the number '1.0' is displayed. At the bottom center, the text 'ON' is displayed.

Step 7

To exit Setup, press and hold MODE button for a few seconds until you return to Run screen.

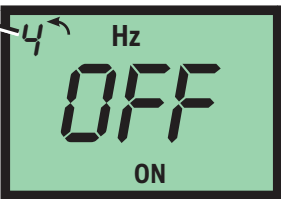

A screenshot of a green LCD screen. In the top left corner, the number '4' is displayed with a small arrow pointing to it from the label 'Mode 4'. To the right of '4' is the text 'Hz'. In the center, the text 'OFF' is displayed. At the bottom center, the text 'ON' is displayed.

11.1 Mode 4 - Pulse Batch Operation Screen Shots

Runtime Screen Shot 1

Display **motor speed percentage**.
 Pump Running in Pulse Batch Operation

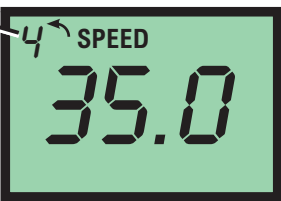

A screenshot of a green LCD screen. In the top left corner, the number '4' is displayed with a small arrow pointing to it from the label 'Mode 4'. To the right of '4' is the text 'SPEED'. In the bottom right corner, the number '35.0' is displayed.

Runtime Screen Shot 2

Display current number of pulses received
 Press and release MODE button to view number of **pulses received** in real-time.

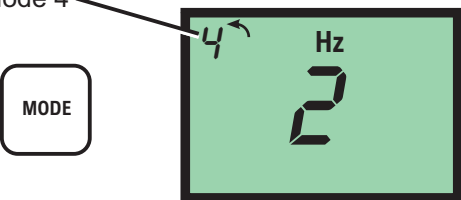

A screenshot of a green LCD screen. In the top left corner, the number '4' is displayed with a small arrow pointing to it from the label 'Mode 4'. To the right of '4' is the text 'Hz'. In the bottom right corner, the number '2' is displayed. To the left of the screen is a button icon labeled 'MODE'.

Runtime Screen Shot 3

Press and release MODE button again to view **mA output** value in real-time
 Press and release MODE button again to view **motor speed percentage**, as in Screen Shot 1.

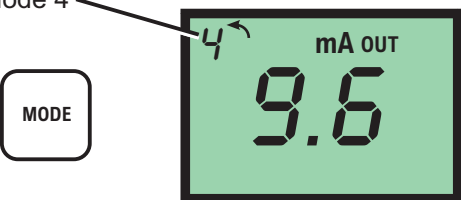

A screenshot of a green LCD screen. In the top left corner, the number '4' is displayed with a small arrow pointing to it from the label 'Mode 4'. To the right of '4' is the text 'mA OUT'. In the bottom right corner, the number '9.6' is displayed. To the left of the screen is a button icon labeled 'MODE'.

12.0 Alarm Relay

Pump has a built in 3 amp alarm output relay. Relay is pre-configured to energize on diaphragm failure detection (DFD) and on Flow Verification Sensor (FVS).

A Flow Verification Sensor must be installed and configured for relay to trigger on no-flow conditions. See page 9 for wiring details.

13.0 Volumetric Test - Calibration

This volumetric test will take into account individual installation factors such as line pressure, fluid viscosity, suction lift, etc. This test is most accurate for measuring injector's output in an individual installation.

1. Be sure Injection Fitting and Footvalve / Strainer are clean and working properly.
2. Fill a large graduated cylinder with solution to be injected.
3. With pump installed under normal operating conditions, place suction tubing with Footvalve / Strainer installed in graduated cylinder.
4. Connect discharge tubing to pump, and then other end to injection point.
5. Run/Prime pump until all air is removed from suction line and solution enters discharge tubing. If pump does not easily prime, relieve pressure on discharge side of pump.
6. Remove suction tubing from graduated cylinder and refill graduated cylinder if necessary. Note amount of solution in graduated cylinder.
7. Place suction tubing with Footvalve / Strainer installed back into graduated cylinder.
8. Run pump for a measured amount of time. A longer testing time will produce more accurate results.
9. Remove suction tubing from graduated cylinder. Measure amount of chemical injected.

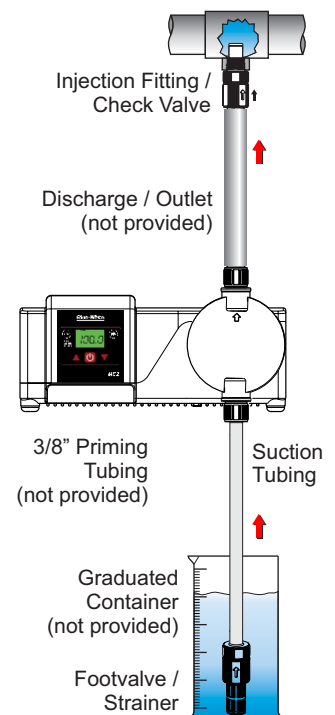

Example:

During your 1 minute calibration period, say CHEM-FEED pumped 1000 Milliliters in 1 minute.

$$1 \text{ US Gallon} = 3.785 \text{ Liters} = 3785 \text{ Milliliters}$$

$$\left(\frac{1000 \text{ ML/Min}}{3785} \right) 60 = 15.85 \text{ GPH (US gallons per hour)}$$

Minutes per hour

Milliliters in a US gallon

Note: All diagrams are strictly for guideline purposes only. Always consult an expert before installing pump into specialized systems. Pump should be **serviced by qualified persons only**.

14.0 Pump Maintenance

CAUTION ⚠	Prior to service, pump clean water through pump and suction / discharge line to remove chemical.
CAUTION ⚠	Always wear protective clothing, face shield, safety glasses and gloves when working on or near your metering pump. Additional precautions should be taken depending on solution being pumped. Refer to MSDS precautions from your solution supplier.

14.1 Routine Inspection and Maintenance

Pump requires very little maintenance. However, pump and all accessories should be checked weekly. This is especially important when pumping chemicals. Inspect all components for signs of leaking, swelling, cracking, discoloration or corrosion. Replace worn or damaged components immediately.

Cracking, crazing, discoloration during first week of operation are signs of severe chemical attack. If this occurs, immediately remove chemical from pump. Determine which parts are being attacked and replace them with parts that have been manufactured using more suitable materials. Manufacturer does not assume responsibility for damage to pump that has been caused by chemical attack.

14.2 Cleaning Pump

Pump will require occasional cleaning, especially Injection fitting, Footvalve / Strainer, and pump head valves. Frequency will depend on type and severity of service.

- Inspect and replace pump head valves as required.
- Periodically clean injection / check valve assembly, especially when injecting fluids that calcify such as sodium hypochlorite. These lime deposits and other build ups can clog fitting, increase back pressure and interfere with check valve operation.
- Periodically clean suction strainer.
- Periodically inspect pump housing (enclosure) for chemical attack. Protect pump housing from continuous exposure to chemicals, such as drips or fumes from surrounding equipment and plumbing.

14.3 Replacing the Pump Diaphragm

- When changing the diaphragm, the pump head chamber and pump head cover should be wiped free of any dirt and debris. The pump stroke must be FORWARD when installing the diaphragm, and BACK when installing and tightening the pump head.
- When replacing the pump diaphragm, note the order of parts per the illustration below.
- Tighten pump head bolts in star-shaped pattern, so as to not overtighten one side. Tighten bolts to 38 ft-lbs.

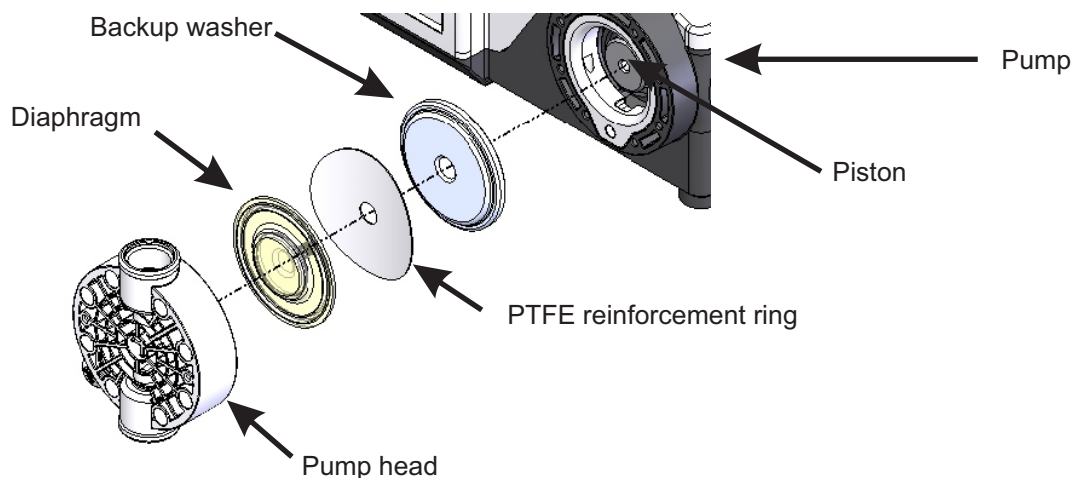

14.4 Motor Brush Replacement

Brushes wear differently on each side of motor. It is recommended to replace both brushes at the same time.

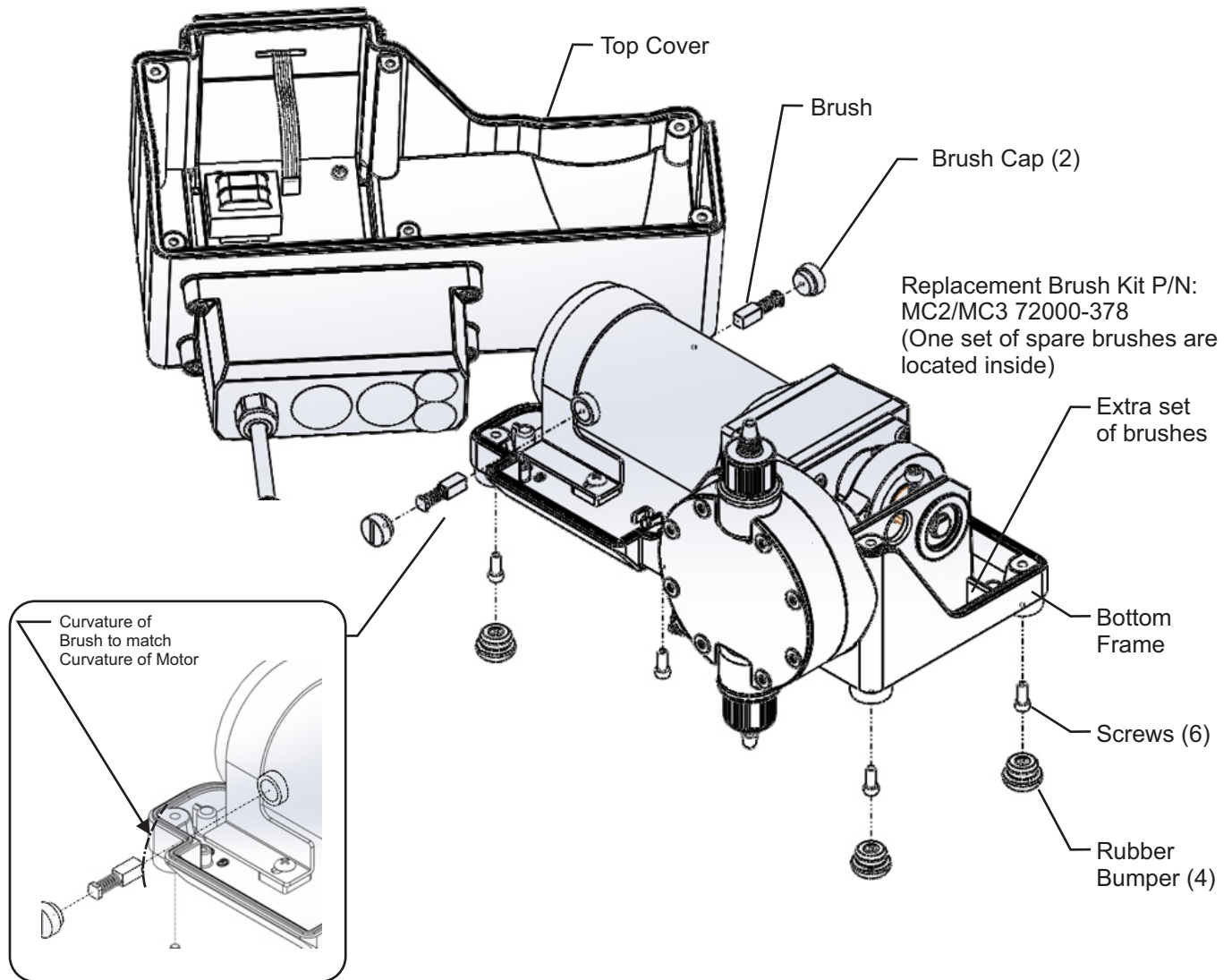

Step 1

Remove 4 black rubber bumpers from bottom frame.

Step 2

Remove 6 screws from underneath side of bottom frame.

Step 4

Lift off top cover from bottom frame carefully. Place top cover close to bottom frame.

Please Note: Wires connecting top and bottom may become unplugged if pulled too far apart.

Step 5

Unscrew and remove brush caps by turning counter-clockwise.

Step 6

Remove used brushes and discard properly.

Step 7

Insert new brushes. Be sure to install brushes to that curvature of brush is concentric to curvature of motor.
Please note: One extra set of brushes are provided inside frame.

15.0 Replacement Parts List

15.1 MC2 Parts List

ITEM	PART NO.	DESCRIPTION	QTY REQ.
2	70004-541	COVER P/H, CM-2, SS	1
3	90011-149	SCREW 10X32 X 1.25	8
4	90011-094	WASHER #10 P/H SS	8
6	71010-446	P/HEAD MICRO Mc2 PVDF	1
	90002-273	P/HEAD SM MC2 PVDF	
	90002-272	P/HEAD LG MC2 PVDF	
7	70001-349	VALVE .5 M/NPT AFLAS	2
	70001-350	VALVE .5 M/NPT EP	
	70001-351	VALVE .5 F/NPT AFLAS	
	70001-352	VALVE .5 F/NPT EP	
	70001-347	VALVE .5 T-BARB AFLAS	
	70001-348	VALVE .5 T-BARB EP	
	70001-372	VALVE .375 TUBE AFLAS	
	70001-373	VALVE .375 TUBE EP	
	8	20000-194	
20000-195		KIT 4 EA. VALVE EP	
9	72000-551	MICRO DIAPHRAGM KIT	1
	72000-296	SMALL DIAPHRAGM KIT	
	72000-297	LARGE DIAPHRAGM KIT	
	72000-606	MICRO DIA KIT FLEX-A-PRENE	
	72000-607	SM DIA KIT FLEX-A-PRENE	
	72000-605	LG DIA KIT FLEX-A-PRENE	
11	71001-002	FRAME INSERT LG. W/SEAL	1
	71001-003	FRAME INSERT SM. W/SEAL	
13	90003-561	BUMPER FEET	4
14	90002-326	UV LCD CVR PLYCRB	1
16	71000-984	J-BOX KIT W/ 115V	1
	71010-032	J-BOX KIT W/ 220V	
	71010-031	J-BOX KIT W/ 230V	
	71010-033	J-BOX KIT W/ 240V	
21	71000-575	FOOTVALVE .5 BRR VIT/AF	1
	71000-447	FTVALVE .5 BRB VT/AF NO SP	
	71000-325	FOOTVALVE .5 BRB EP NO SP	
22	90008-043	CLAMP SS .5"	1

*See page 31 for motor brush replacement.

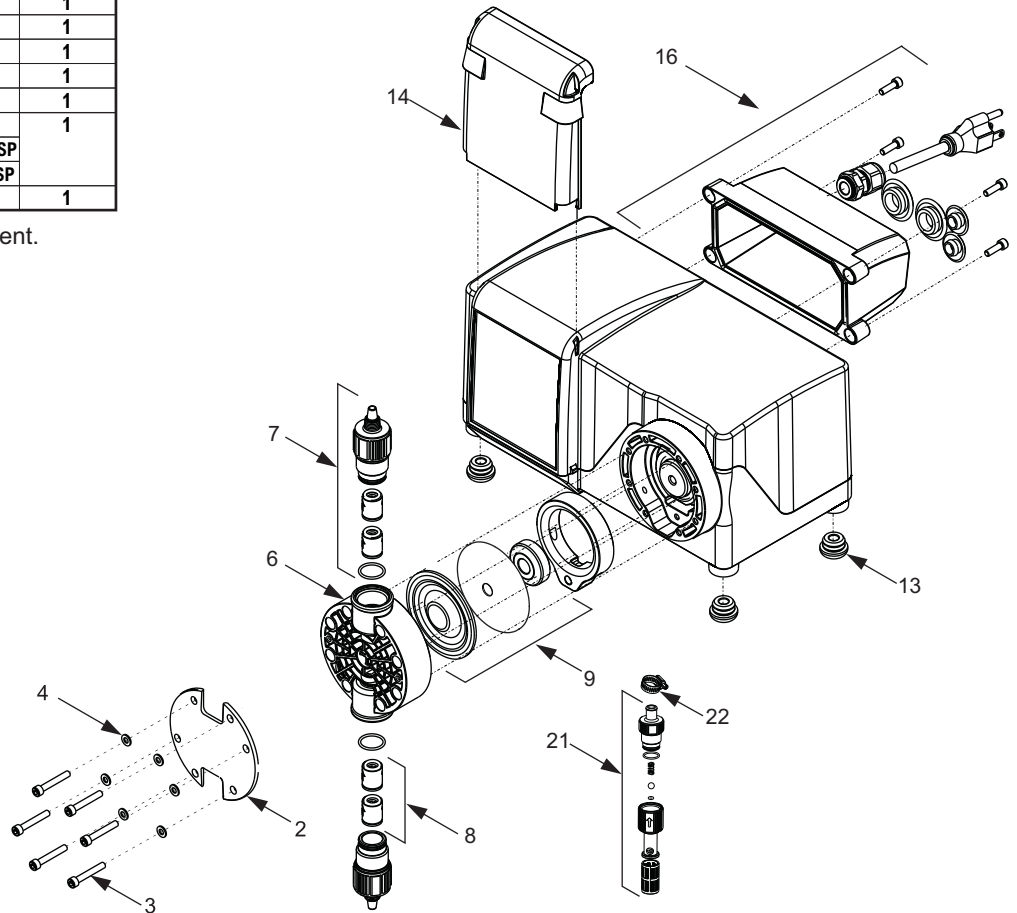

15.2 MC3 Parts List

ITEM	PART NO.	DESCRIPTION	QTY REQ.
2	70004-540	COVER P/H, CM-3, SS	1
3	90011-149	SCREW 10X32 X 1.25	8
4	90011-094	WASHER #10 P/H SS	8
6	90002-258	P/HEAD LG C3 PVDF	1
7	70001-349	VALVE .5 M/NPT AFLAS	2
	70001-350	VALVE .5 M/NPT EP	
	70001-351	VALVE .5 F/NPT AFLAS	
	70001-352	VALVE .5 F/NPT EP	
	70001-347	VALVE .5 T-BARB AFLAS	
	70001-348	VALVE .5 T-BARB EP	
8	20000-194	KIT 4 EA. VALVE AFLAS	1
	20000-195	KIT 4 EA. VALVE EP	
9	72000-295	DIAPHRAGM KIT	1
	72000-604	DIAPHRAGM KIT FLEX-A-PRENE	
13	90003-561	BUMPER FEET	4
14	90002-326	UV LCD CVR PLYCRB	1
16	71000-984	J-BOX KIT W/ 115V	1
	71010-032	J-BOX KIT W/ 220V	
	71010-031	J-BOX KIT W/ 230V	
	71010-033	J-BOX KIT W/ 240V	
21	71000-575	FOOTVALVE .5 BARB VIT/AF	1
	71000-447	FTVALVE .5 BRB VT/AF NO SP	
	71000-325	FOOTVALVE .5 BRB EP NO SP	
22	90008-043	CLAMP SS .5"	1

*See page 31 for motor brush replacement.

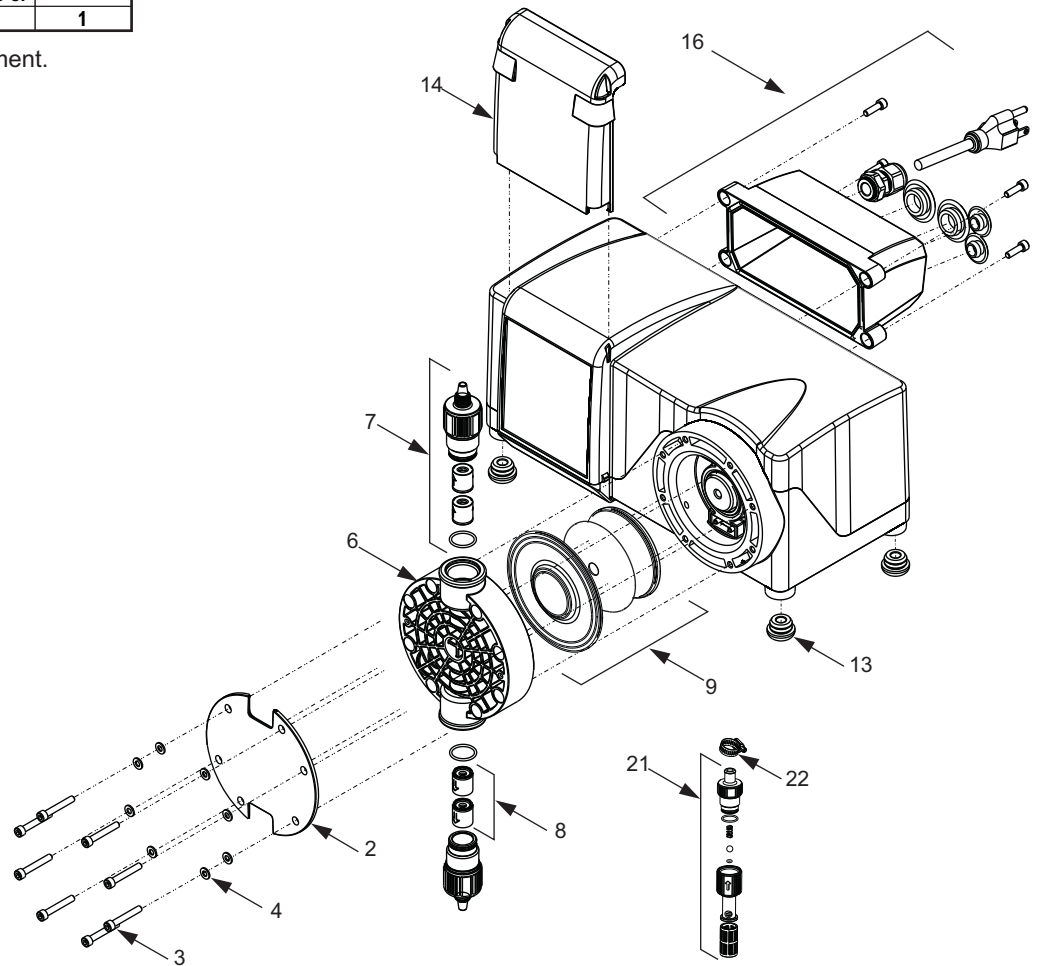

16.0 DFD (Diaphragm Failure Detection)

CHEM-FEED® is equipped with a Diaphragm Failure Detection System which is designed to stop pump and provide an output alarm in event diaphragm should rupture and chemical enters pump head. Pump will detect a chemical with a conductivity reading greater than 500 microsiemens. Chemicals with a conductivity of less than 500 microsiemens will not be detected.

This system is capable of detecting presence of a large number of chemicals including Sodium Hypochlorite (Chlorine), Hydrochloric (muriatic) Acid, Sodium Hydroxide, and many others. System will not be triggered by water (rain, condensation, etc.) or lubricants.

If system has detected chemical, pump diaphragm must be replaced and pump head must be thoroughly cleaned. Failure to clean pump head will void warranty.

If DFD alarm occurs, pump will stop, close an alarm output, and screen will flash DFD with an alarm icon.

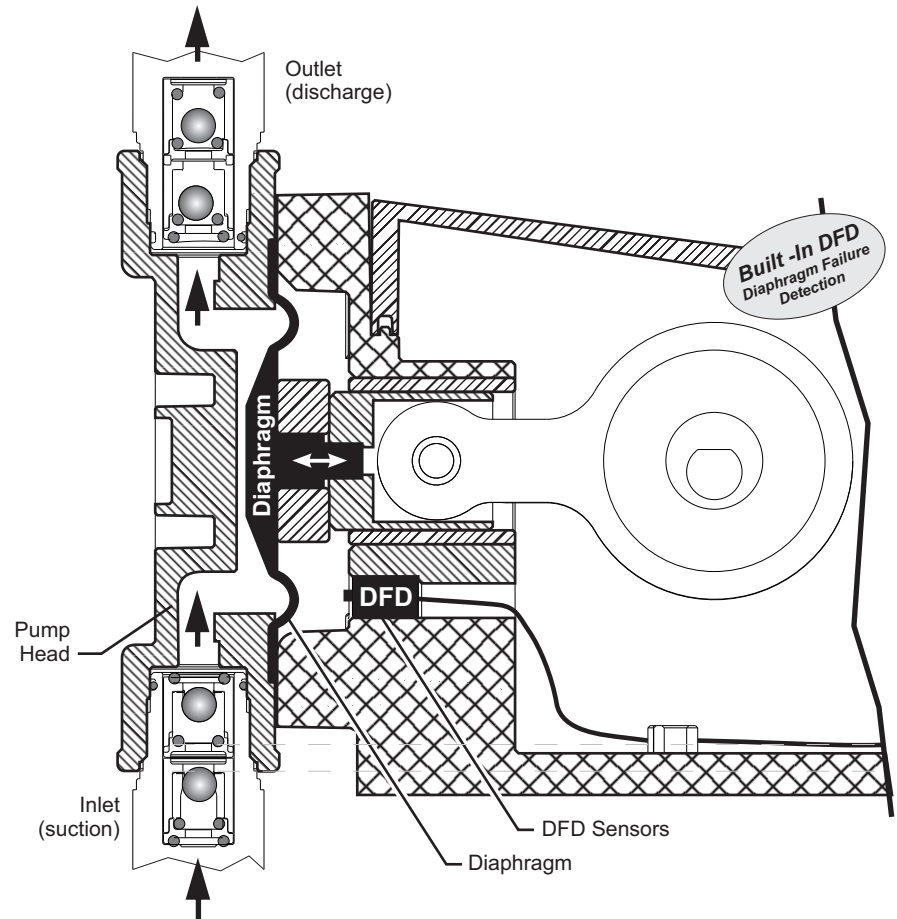

Typical Installation

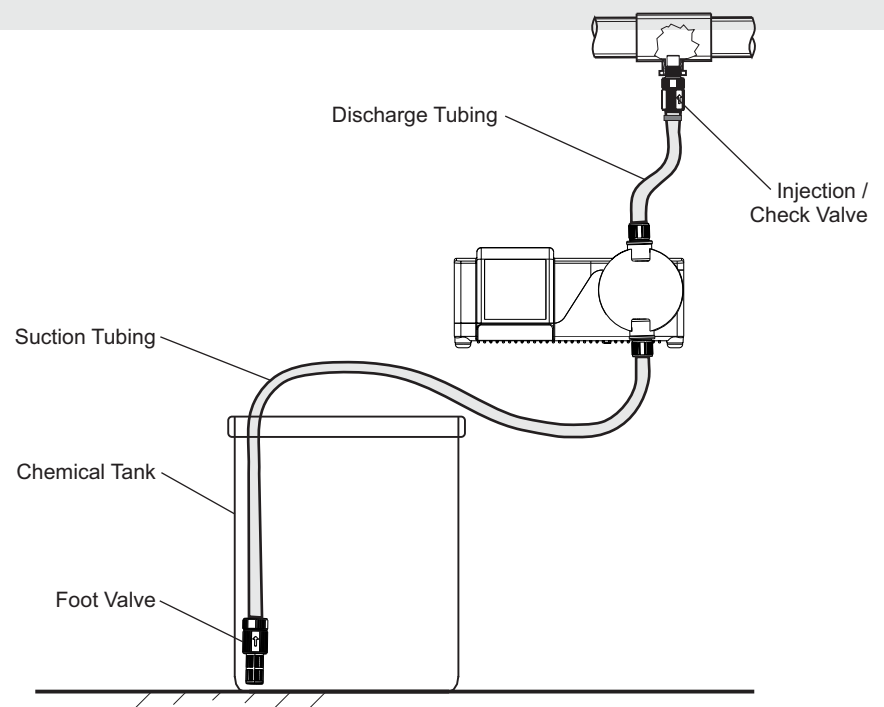

17.0 Output Versus Pressure

17.1 MC2 Output V. Pressure

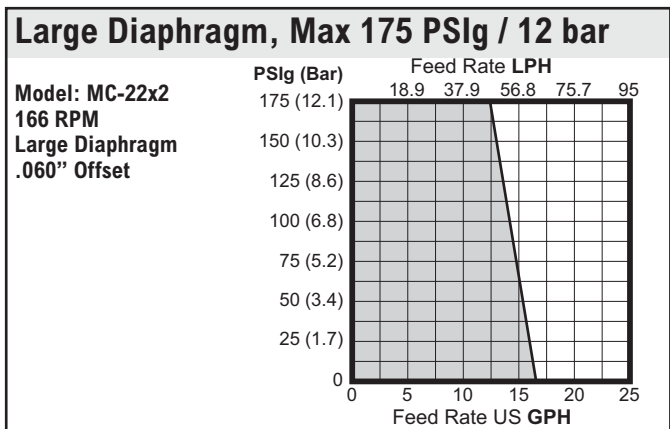
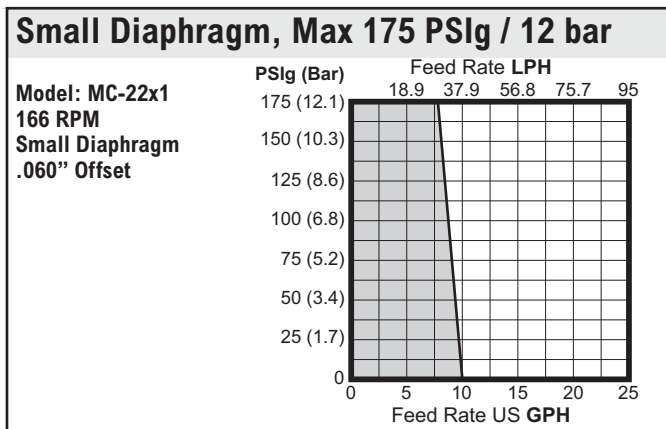
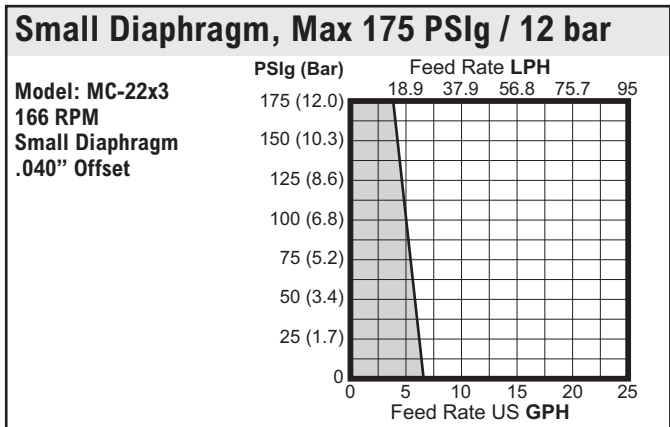
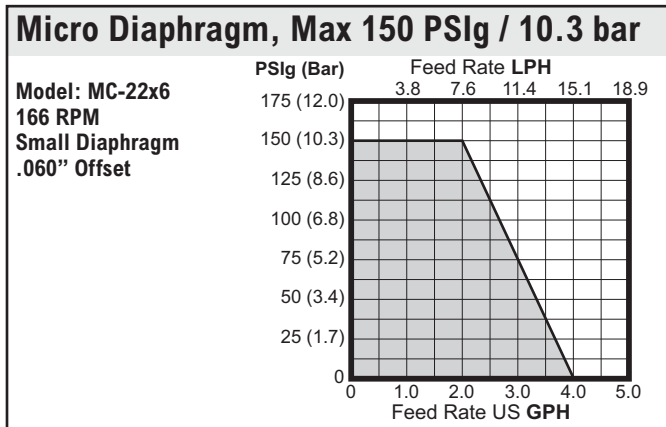
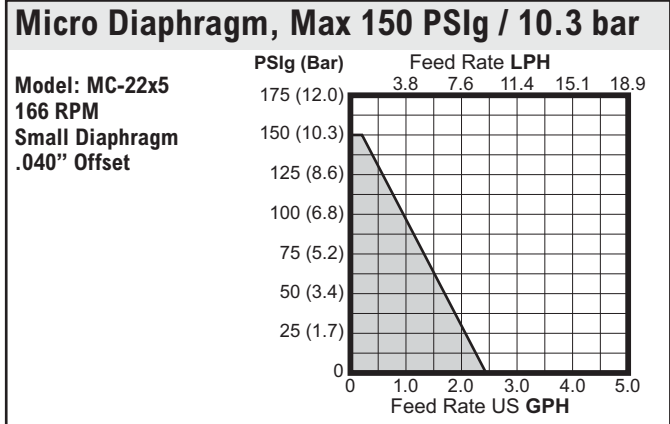

17.2 MC3 Output V. Pressure

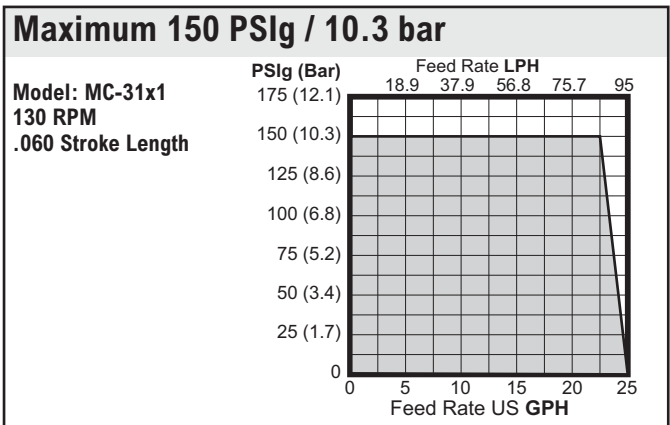
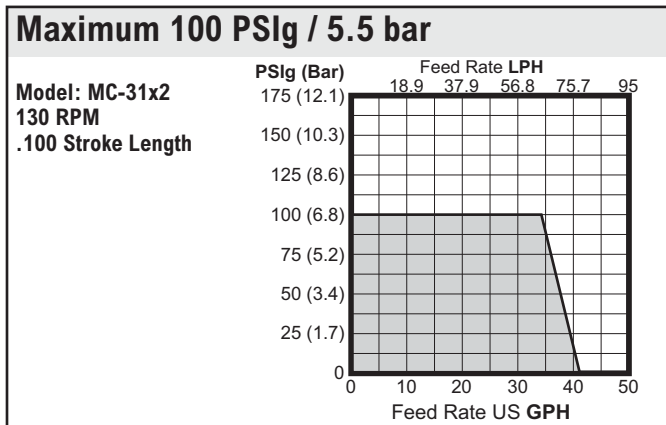

MC2 Model Number Matrix

Model Number Matrix

MC2

CHEM-FEED® Model Number

MC	CHEM-FEED® Diaphragm metering pump							
Input Voltage / Power Cord								
4	115V / 60Hz, power cord NEMA 5/15 plug (US)			8	240V / 50HZ, power cord AS 3112 plug (AU/New Zealand)			
5	230V / 60Hz, power cord NEMA 6/15 plug (US)			9	230V / 50HZ, power cord BS 1363 plug (UK)			
6	220V / 50HZ, power cord CEE 7/VI plug (EU)							
Stroke Length / Diaphragm size								
1	.060" stroke / small diaphragm .05–10 GPH 175 PSI							
2	.060" stroke / large diaphragm .08–16.5 GPH 175 PSI							
3	.040" stroke / small diaphragm .03–6.7 GPH 175 PSI							
5	.040" stroke / Micro-Feed .01–2.3 GPH 150 PSI							
6	.060" stroke / Micro-Feed .02–4.0 GPH 150 PSI							
Elastomer Material (o-rings)								
V	TFE/P							
E	EP (Ethylene Propylene)							
Pump Head Fittings								
1	1/2" ID Hose Barb Tubing pump head							
2	1/4" ID x 3/8" OD Tubing pump head							
3	1/2" Male NPT inlet and outlet							
4	1/2" Female NPT inlet and outlet							
Miscellaneous Options (leave blank if not used)								
(blank)	Standard							
S	Flex-A-Prene® Diaphragms (Caustic Soda resistant diaphragms)							
MC	2	2	4	1	X	V	1	Sample Model Number

MC3 Model Number Matrix

Model Number Matrix

MC3

CHEM-FEED® Model Number

MC	CHEM-FEED® Diaphragm metering pump							
Input Voltage / Power Cord								
4	115V / 60Hz, power cord NEMA 5/15 plug (US)			8	240V / 50HZ, power cord AS 3112 plug (AU/New Zealand)			
5	230V / 60Hz, power cord NEMA 6/15 plug (US)			9	230V / 50HZ, power cord BS 1363 plug (UK)			
6	220V / 50HZ, power cord CEE 7/VII plug (EU)							
Stroke Length / Diaphragm size								
1	.060" stroke / large diaphragm .13–26.2 GPH 150 PSI							
2	.100" stroke / large diaphragm .20–40.6 GPH 100 PSI							
Elastomer Material (o-rings)								
V	TFE/P							
E	EP (Ethylene Propylene)							
Pump Head Fitting and Injection Fitting / Check Valve Connections								
1	1/2" ID Hose Barb Tubing pump head							
2	1/4" ID x 3/8" OD Tubing pump head							
3	1/2" Male NPT inlet and outlet							
4	1/2" Female NPT inlet and outlet							
Diaphragm Type								
(blank)	Standard							
S	Flex-A-Prene® Diaphragms (Caustic Soda resistant diaphragms)							
MC	3	1	4	1	X	V	1	Sample Model Number

THIS PAGE INTENTIONALLY LEFT BLANK.

19.0 WARRANTY

19.1 Limited Warranty

Your Blue-White product is a quality product and is warranted for a specific time from date of purchase (proof of purchase is required). The product will be repaired or replaced at our discretion. Failure must have occurred due to defect in material or workmanship and not as a result of operation of the product other than in normal operation as defined in the product manual. Warranty status is determined by the product's serial label and the sales invoice or receipt. The serial label must be on the product and legible. The warranty status of the product will be verified by Blue-White or a factory authorized service center.

CHEM-FEED® MC2 and MC3 pumps are warranted for 2 years from date of purchase (proof of purchase is required). Pumps will be repaired or replaced at our discretion.

19.2 DIAFLEX® Warranty

DIAFLEX® diaphragms are warranted for the life of the pump. Blue-White will replace a damaged diaphragm at no cost to the customer provided the pump was at all times operated within the guidelines included in the pump's operation manual. This warranty only applies to DIAFLEX® diaphragms, not the pumps themselves. Blue-White pumps are separately covered by warranties specific to them.

19.3 What is not Covered

- > **Flex-A-Prene diaphragm and rubber components - They are perishable and require periodic replacement**
- > **Pump removal, or re-installation, and any related labor charge.**
- > **Freight to the factory, or service center**
- > **Pumps that have been tampered with, or in pieces.**
- > **Damage to the pump that results from misuse, carelessness (such as chemical spills on the enclosure), abuse, lack of maintenance, or alteration that is out of Blue-White control.**
- > **Pumps damaged by faulty wiring, power surges, or acts of nature.**

Blue-White does not assume responsibility for any loss, damage, or expense directly or indirectly related to or arising out of the use of its products. Failure must have occurred due to defect in material or workmanship and not as a result of operation of the product other than in normal operation as defined in the pump operation manual.

The warranty status is determined by the pump's serial label and the sales invoice or receipt. The serial label must be on the pump and be legible. The warranty status of the pump will be verified by Blue-White or a factory authorized service center.

19.4 Procedure for In-Warranty Repair

Warranty service must be performed by the factory or an authorized service center. Contact the factory or local repair center to obtain a RMA (Return Material Authorization) number. It is recommended to include foot strainer and injection/check valve fitting since these devices may be clogged and part of the problem. Decontaminate, dry, and carefully pack the product to be repaired. Please enclose a brief description of the problem and proof of purchase. Prepay all shipping and insurance cost. COD shipments will not be accepted. Damage caused by improper packaging is the responsibility of the sender. When In-Warranty repair is completed, the factory pays for return shipping to the dealer or customer.

19.5 Product Use Warning

Blue-White products are manufactured to meet the highest quality standards in the industry. Each product instruction manual includes a description of the associated product warranty and provides the user with important safety information. Purchasers, installers, and operators of Blue-White products should take the time to inform themselves about the safe operation of these products. In addition, Customers are expected to do their own due diligence regarding which products and materials are best suited for their intended applications. Blue-White is pleased to assist in this effort but does not guarantee the suitability of any particular product for any specific application as Blue-White does not have the same degree of familiarity with the application that the customer/end user has. While Blue-White will honor all of its product warranties according to their terms and conditions, Blue-White shall only be obligated to repair or replace its defective parts or products in accordance with the associated product warranties. **BLUE-WHITE SHALL NOT BE LIABLE EITHER IN TORT OR IN CONTRACT FOR ANY LOSS OR DAMAGE WHETHER DIRECT, INDIRECT, INCIDENTAL, OR CONSEQUENTIAL, ARISING OUT OF OR RELATED TO THE FAILURE OF ANY OF ITS PARTS OR PRODUCTS OR OF THEIR UNSUITABILITY FOR A GIVEN PURPOSE OR APPLICATION.**

19.6 Chemical Resistance Warning

Blue-White offers a wide variety of wetted parts. Purchasers, installers, and operators of Blue-White products must be well informed and aware of the precautions to be taken when injecting or measuring various chemicals, especially those considered to be irritants, contaminants or hazardous. Customers are expected to do their own due diligence regarding which products and materials are best suited for their applications, particularly as it may relate to the potential effects of certain chemicals on Blue-White products and the potential for adverse chemical interactions.

Blue-White tests its products with water only. The chemical resistance information included in this instruction manual was supplied to Blue-White by reputable sources, but Blue-White is not able to vouch for the accuracy or completeness thereof. While Blue-White will honor all of its product warranties according to their terms and conditions, Blue-White shall only be obligated to repair or replace its defective parts or products in accordance with the associated product warranties.

BLUE-WHITE SHALL NOT BE LIABLE EITHER IN TORT OR IN CONTRACT FOR ANY LOSS OR DAMAGE, WHETHER DIRECT, INDIRECT, INCIDENTAL, OR CONSEQUENTIAL, ARISING OUT OF OR RELATED TO THE USE OF CHEMICALS IN CONNECTION WITH ANY BLUE-WHITE PRODUCTS.

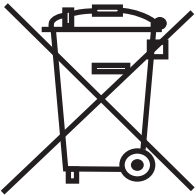

Users of electrical and electronic equipment (EEE) with the WEEE marking per Annex IV of the WEEE Directive must not dispose of end of life EEE as unsorted municipal waste, but use the collection framework available to them for the return, recycle, recovery of WEEE and minimize any potential effects of EEE on the environment and human health due to the presence of hazardous substances. The WEEE marking applies only to countries within the European Union (EU) and Norway. Appliances are labeled in accordance with European Directive 2002/96/EC.

Contact your local waste recovery agency for a *Designated Collection Facility* in your area.

Blue-White[®]

5300 Business Drive
Huntington Beach, CA 92649
USA

TEL: 714-893-8529
FAX: 714-894-9492

www.blue-white.com
sales@blue-white.com
customerservice@blue-white.com