

FLEXFLO[®]

Peristaltic Metering Pump



M2

1.0	Introduction	4
	1.1 Available Models	4
2.0	Specifications	5
	2.1 Materials of Construction	5
3.0	Features	6
	3.1 Agency Listings	6
4.0	Installation	7
	4.1 Mounting Location	7
	4.2 Dimensions	7
	4.3 Installing Injection Fitting and Strainer	8
5.0	Power Connections	9
	5.1 Wiring Terminal and I/O Schematics	10
6.0	How to Operate FLEXFLO® - Control Pad	11
	6.1 Mode Descriptions	12
7.0	Mode0 - Set Remote Start/Stop	13
	7.1 Mode 0 - Set TFD Sensitivity	14
	7.2 Mode 0 - Set FVS (flow verification system)	15
	7.3 Mode 0 - Set 4-20mA Output	17
	7.4 Mode 0 - Set Flow Rate (Pump Calibration)	19
	7.4.1 Mode 0 - Operation Screens Displaying Flow Rate	20
8.0	Mode 1 - Manual Operation	21
	8.1 Mode 1 - Manual Operation Screen Shots	22
9.0	Mode 2 - 4-20mA Input Operation	23
	9.1 Mode 2 - 4-20mA Input Screen Shots	24
10.0	Mode 3 - Frequency Input (Hz) Operation	25
11.0	Mode 4 - Pulse Batch (low speed pulse) Operation	27
	11.1 Mode 4 - Pulse Batch Operation Screen Shots	28
12.0	Pump Tube Timer	29
13.0	TFD (Tube Failure Detection)	29
14.0	Alarm Relay	30
15.0	Reverse Rotation	30
16.0	Tube Replacement	31
	16.1 Cover "CVR" and Tube Removal	31
	16.2 Tube Installation	32
17.0	Pump Maintenance	33
	17.1 Motor Brush Replacement	34
18.0	Pump Head Replacement Parts List	35
19.0	Output Versus Fluid Viscosity	36
20.0	Volumetric Test - Calibration	37
21.0	Warranty	38
22.0	Model Number Matrix	39

READ THE ENTIRE OPERATING MANUAL PRIOR TO INSTALLATION AND USE.



+1 (714) 893 - 8529



sales@blue-white.com



customerservice@blue-white.com



5300 Business Drive
Huntington Beach, CA 92649

1.0 Introduction

Congratulations on purchasing FLEXFLOo variable speed Peristaltic Metering Pump. A peristaltic pump is a type of positive displacement pump used for pumping a variety of fluids.

Your FLEXFLO pump is pre-configured for the tubing that shipped with your metering pump. Tubing assembly has an Identification number printed on tube for easy re-order; such as ND, NGG, etc.

Please Note: Your new pump has been pressure tested at factory with clean water before shipping. You may notice trace amounts of clean water in pre-installed tube assembly.

1.1 Available Models

Feed Rate			Max Speed	Max Pressure	Max Temperature	M2 Model Numbers		
Flex-A-Prene® M2 Tube Pumps								
Meets FDA criteria for food Excellent chemical resistance CIP SIP								
GPH	LPH	ML/Min	RPM	PSI (bar)	F (C)	115V AC	230V AC	220V AC
.01 - 1.7	.03 - 6.5	.54 - 108	130	125 (8.6)	185 (85)	M224-*ND	M225-*ND	M226-*ND
Flex-A-Prene® M2 Tube Pumps								
Meets FDA criteria for food Excellent chemical resistance Extra long tube life								
GPH	LPH	ML/Min	RPM	PSI (bar)	F (C)	115V AC	230V AC	220V AC
.022 - 4.44	.084 - 16.8	1.4 - 280	130	110 (7.6)	185 (85)	M224-*NEE	M225-*NEE	M226-*NEE
.086 - 17.2	.325 - 65.1	5.4 - 1085	130	110 (7.6)	185 (85)	M224-*NGG	M225-*NGG	M226-*NGG
Flex-A-Chem® M2 Tube Pumps								
Meets FDA criteria for food Superb chemical resistance								
GPH	LPH	ML/Min	RPM	PSI (bar)	F (C)	115V AC	230V AC	220V AC
.07 - 14.3	.27 - 54	4.5 - 900	130	50 (3.4)	130 (54)	M224-*TH	M225-*TH	M226-*TH
Flex-A-Thane® M2 Tube Pumps								
Meets FDA criteria for food Resistant to oils, greases and fuels								
GPH	LPH	ML/Min	RPM	PSI (bar)	F (C)	115V AC	230V AC	220V AC
.02 - 4.0	.08 - 15.2	1 - 253	130	65 (4.5)	130 (54)	M224-*GE	M225-*GE	M226-*GE
.05 - 9.3	.17 - 35.2	3 - 587	130	65 (4.5)	130 (54)	M224-*GG	M225-*GG	M226-*GG
.07 - 14.98	.03 - 56.7	4.7 - 945	130	65 (4.5)	130 (54)	M224-*G2G	M225-*G2G	M226-*G2G
.10 - 21.23	.04 - 80.4	6.6 - 1340	130	65 (4.5)	130 (54)	M224-*GH	M225-*GH	M226-*GH
* Inlet/outlet connection type S = 3/8" OD x 1/4" ID tubing compressions type connections M = 1/2" male NPT B = 1/2" Hose barb, Natural PVDF (Kynar), (ND, NEE, NGG, and G2G only) C = 1/2" - 3/4" tri-clamp connections (ND, NEE, NGG, and G2G only) Q = Quick Disconnect (ND, NEE, NGG, and G2G only) (Valves sold separately) For optimum tube life, specify pump to operate at lowest possible RPM and pressure. Feed rates taken in laboratory environment with clean water after 20 minute tube break-in period with a 3 foot (1 meter) suction lift.								

Optional Extended Brackets

Stainless Steel extended brackets allow pump to be securely mounted to most any surface; floor, shelf, or skid. Brackets lift pump up 4-1/2 inches (11.43 cm), for easy pump access in hard to reach areas.

- Raise metering pump 4-1/2 inches (11.43 cm) off ground or a surface.
- Made out of tough Stainless Steel.
- Provides a stable mounting surface.

Model #	Description
72000-380	Extended Mounting Bracket, 1 Pair, SS, 4 SS Screws



2.0 Specifications

<p>Maximum working pressure: 125 psig (8.6 bar) Note: see individual pump tube assembly maximum pressure ratings.</p> <p>Maximum Fluid temperature: 3/8" OD x 1/4" ID tubing connections: 130° F (54° C) M/NPT connections: 185° F (85° C) Note: see individual pump tube assembly maximum temperature ratings.</p> <p>Maximum fluid viscosity: 12,000 Centipoise</p> <p>Maximum suction lift: 30 ft. Water, 0 psig (14.7 m, 0 bar)</p> <p>Ambient Operating Temperature 14°F to 115°F (-10°C to 46°C)</p> <p>Ambient Storage Temperature -40°F to 158°F (-40°C to 70°C)</p> <p>Operating Voltage: 115VAC/60Hz, 1ph (1.5 Amp Maximum) 230VAC/60Hz, 1ph (0.7 Amp Maximum) 220VAC/50Hz, 1ph (1.0 Amp Maximum) 240VAC/50Hz, 1ph (1.0 Amp Maximum)</p>	<p>Power Cord Options: 115V60Hz = NEMA 5/15 (USA) 230V60Hz = NEMA 6/15 (USA) 220V50Hz = CEE 7/II (EU) 240V50Hz = AS 3112 (Australia/New Zealand) 230V50Hz = BS 1363 plug (UK)</p> <p>Motor: Brushed DC, 1/8 H.P.</p> <p>Duty cycle: Continuous</p> <p>Motor speed adjustment range 200:1: 0.5% - 100% motor speed (0.7 to 130 RPM)</p> <p>Motor speed adjustment resolution: 0.1% increments</p> <p>Display Backlit LCD, UV resistant.</p> <p>Keypad Eight button positive action tactile switch keypad.</p> <p>Enclosure: NEMA 4X (IP66), Polyester powder coated aluminum. Maximum Overall Dimensions: 7-1/2" W x 10-1/4" H x 14" D (19 W x 26 H x 35.6 D cm)</p> <p>Approximate shipping wt: 25 lb. (12.0 Kg)</p>
---	---

2.1 Materials of construction

<p>Wetted components:</p> <p>Pump Tube Assembly (Model Specific - 2 provided): Tubing: Flex-A-Prene® or Flex-A-Chem® or Flex-A-Thane® Adapter fittings: .PVDF</p> <p>Injection / Back-flow Check valve (sold seperately): Body & insert:PVDF Check Ball:Ceramic Spring:Hastelloy C-276 Ball Seat O-ring:TFE/P (optional EPDM) Static Seal O-ring:TFE/P (optional EPDM)</p> <p>Recommended Ancillary Items (sold seperately):</p> <p>With "S" tubing type connections only: Suction Tubing: 3/8" OD x 1/4" ID x 10' Clear PVC Discharge Tubing: 3/8" OD x 1/4" ID x 10' Polyethylene (LLDPE) Suction Strainer: PVDF</p> <p>With "B" tubing and "M" M/NPT connections only: Suction Strainer: Body: PVDF</p>	<p>Non-Wetted components:</p> <p>Enclosure: 413 Aluminum (Polyester powder coated)</p> <p>Pump Head: Valox® (PBT) thermoplastic</p> <p>Pump Head Cover: Polycarbonate for added strength and chemical resistance. Permanently lubricated sealed motor shaft support ball bearing.</p> <p>Cover Screws: Stainless Steel</p> <p>Roller Assembly: Rotor:Valox® (PBT) Rollers:Nylon Roller Bearings:SS Ball Bearings</p> <p>Motor Shaft: Chrome plated steel</p> <p>TFD System Sensor pins: Hastelloy C-276</p> <p>Power Cord: 3 conductor, SJTW-A Water-resistant</p> <p>Tube Installation Tool: GF Nylon</p> <p>Mounting Brackets and Hardware: 316 Stainless Steel</p>
--	--

3.0 Features

Peristaltic pump design does not have valves that can clog requiring maintenance.

Self priming - even against maximum line pressure. By-pass valves are not required. Cannot vapor lock or lose prime.

Variable speed DC motor.

Rated for continuous duty (24X7).

Specially engineered tubing for long life at high pressures. Meets FDA 21 CFR requirements for food contact applications.

Patented Tube Failure Detection (TFD) system. Senses tube failure by detecting chemical in pump head.

Backlit LCD displays motor speed, input signal values, service and alarm status.

Precision molded squeeze and alignment rollers for optimum squeeze, unparalleled accuracy, and tube life.

Heavy duty rotor - single piece plastic rotor means no flexing and increased accuracy with no metal springs or hinges to corrode.

Inject at maximum pressure in either direction (clockwise and counter clockwise).

Compatible with Blue-White's output Flow Verification Sensor (FVS) system.

3.1 Agency Listings



This pump is certified to NSF/ANSI Standard 61 - Drinking Water System Components - Health Effects



This pump is ETL listed to conform to the following: UL Standard 778 as a motor operated water pump CSA Standard C22.2 as process control equipment



This pump complies to the Machinery Directive 2006/42/EC, BS, EN 60204-1, Low Voltage Directive 2014/35/EU BS EN 61010-1, EMC Directive 2014/30/EU, BS EN 50081-1/BS EN 50082-1.

Symbol	Explanation
	WARNING, risk of electric shock
	CAUTION, refer to users' guide
	GROUND, PROTECTIVE CONDUCTOR TERMINAL

Enclosure Rating:

NEMA 4X: Constructed for either indoor or outdoor use to provide a degree of protection to personnel against incidental contact with enclosed equipment; to provide a degree of protection against falling dirt, rain, sleet, snow, windblown dust, splashing water, and hose-directed water; and that will be undamaged by external formation of ice on enclosure.

IP66: No ingress of dust; complete protection against contact. Water projected in powerful jets against enclosure from any direction shall have no harmful effects.

4.0 Installation

CAUTION Risk of chemical overdose. Be certain pump does not overdose chemical during backwash and periods of no flow in circulation system.

CAUTION Always wear protective clothing, face shield, safety glasses and gloves when working on or near your metering pump. Additional precautions should be taken depending on solution being pumped. Refer to MSDS precautions from your solution supplier.

CAUTION All diagrams are strictly for guideline purposes only. Always consult an expert before installing metering pump on specialized systems. Metering pump should be serviced by qualified persons only.

4.1 Mounting Location

Choose an area located near chemical supply tank, chemical injection point, and electrical supply. Install pump where it can be easily serviced.

316SS Mounting brackets are included. Mount pump to a secure surface using enclosed mounting hardware.

Mount pump close to injection point. Keep inlet (suction) and outlet (discharge) tubing as short as possible. Longer discharge tubing increases back pressure at pump head.

Important! Install a back flow prevention check valve at discharge side of pump to prevent system fluid from flowing back through pump during tube replacement or if tube should rupture. **Important!**

A pressure relief valve is recommended at discharge of pump to prevent premature wear and damage to pump tube in event discharge line becomes blocked.

Flex-Pro pump does not require back pressure. Keep discharge pressure as low as possible to maximize tube life.

4.2 Dimensions

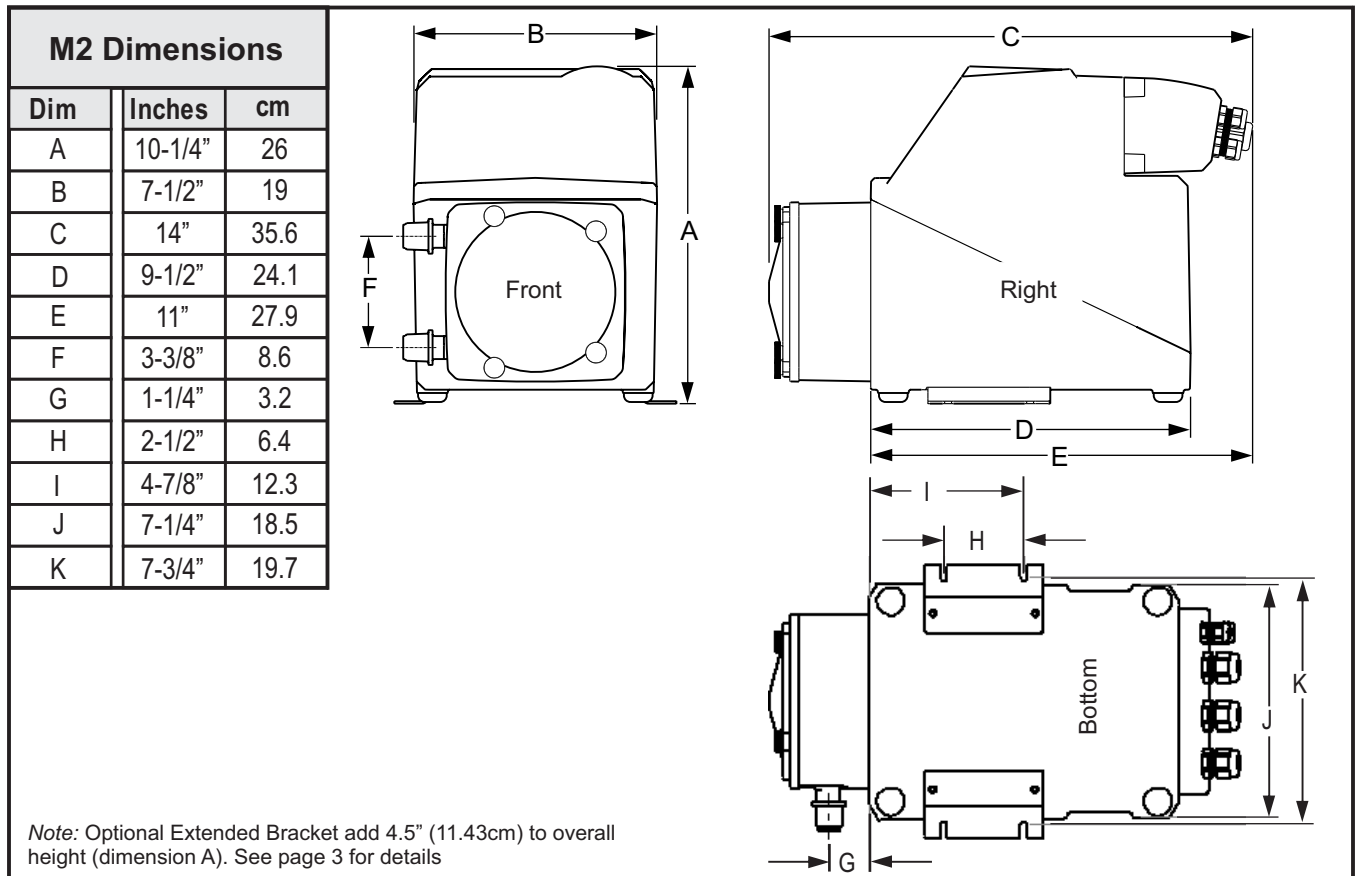



4.3 Installing Blue-White Injection Fitting and Strainer (not included)

CAUTION Proper eye and skin protection must be worn when installing and servicing pump.

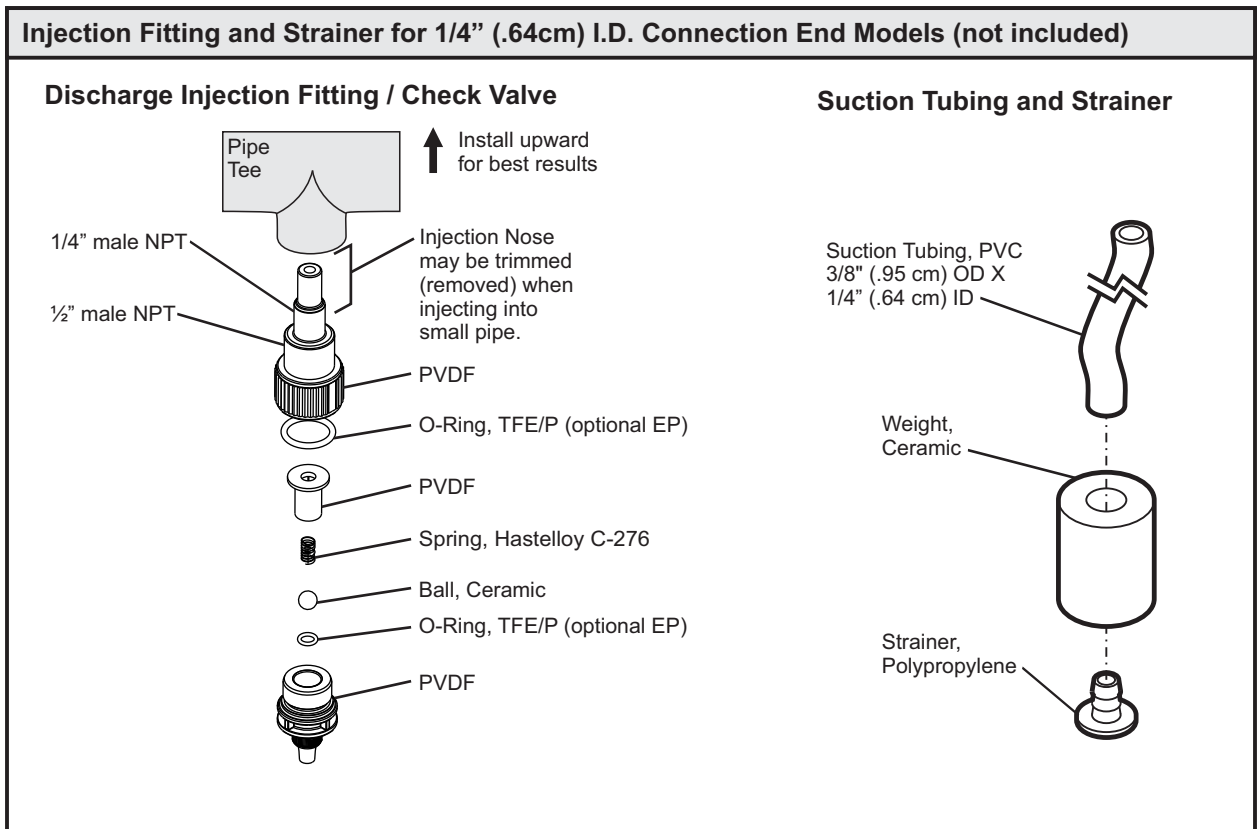
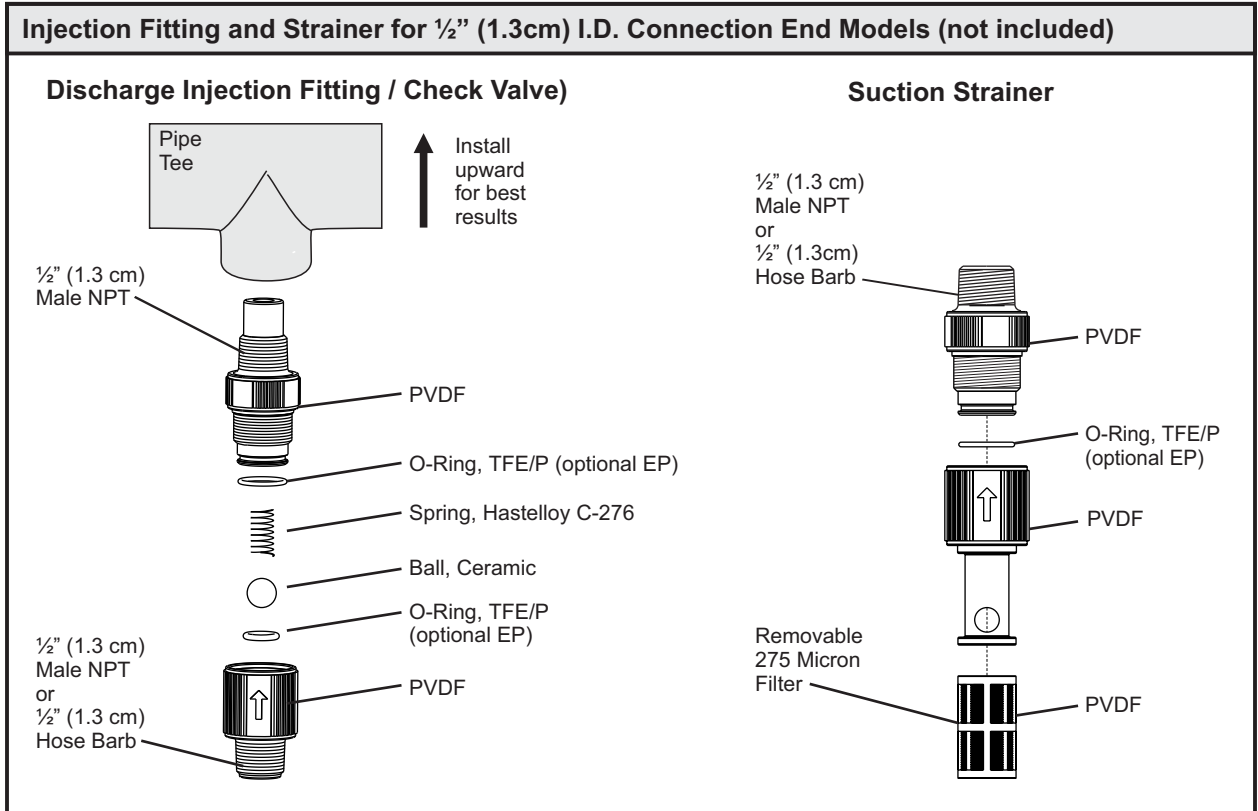
CAUTION This Pump Has Been Evaluated for Use with Water Only.



5.0 Power Connections

WARNING 	Risk of electric shock – cord connected models are supplied with a grounding conductor and grounding-type attachment plug. To reduce risk of electric shock, be certain that it is connected only to a properly grounded, grounding-type receptacle.
WARNING 	Electrical connections and grounding (earthing) must conform to local wiring codes. Be certain that a grounding conductor is connected to terminal T11-1 located in wiring compartment.
WARNING 	Risk of electric shock - Disconnect electricity before removing wiring compartment cover.

Be certain to connect pump to proper supply voltage. Using incorrect voltage will damage pump and may result in injury. Voltage requirement is printed on pump serial label.

Input power: 115VAC 50/60 Hz 1.5 amp or 230/240VAC 50/60 Hz 0.7 amp.

Power switch located in Junction Box.

Use voltage your power cord is rated for.

Cord connected models are supplied with a ground wire conductor and a grounding type attachment plug (power cord). To reduce risk of electric shock, be certain that power cord is connected only to a properly grounded, grounding type receptacle.

Permanently connected models must be properly grounded. Be certain that a grounding conductor is connected to terminal T11-1 located in wiring compartment.

Never strap control (input / output) cables and power cables together.

Power Interruption: This pump has an auto-restart feature which will restore pump to operating state it was in when power was lost.

Note: When in doubt regarding your electrical installation, contact a licensed electrician.

WIRING COMPARTMENT COVER

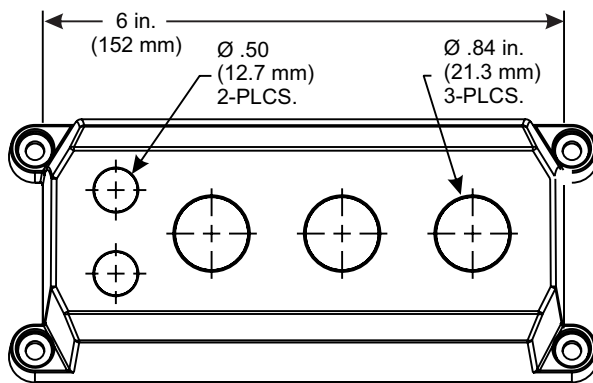

POWER CORD OPTIONS

Three power cord plug types available. Power cord length is 6 feet (3.83 meters)



115V 60Hz
NEMA 5/15 (USA)
max: 125V AC

230V 60Hz
NEMA 6/15 (USA)
max: 250V AC

240V 50Hz
CEE 7/VII (EU)
max: 250V AC

Included cable and conduit connectors:

QTY.	DESCRIPTION
Qty: 2	.50 Inch (12.7 Mm) Liq-tight Hole Plugs (mat'l = Neoprene), Pre-installed
Qty: 3	.875 Inch (22.2 Mm) Liq-tight Hole Plugs (mat'l = Neoprene), 2 Pre-installed
Qty: 2	.50 Inch (12.7 Mm) Liq-tight Connectors For Pass Thru Cords (mat'l = Nylon) Acceptable Cable Diameter .12 To .26 Inch (3.0 To 6.5 Mm), Not Installed
Qty: 3	.875 Inch (22.2 Mm) Liq-tight Connectors For Pass Thru Cords (mat'l = Nylon) Acceptable Cable Diameter .20 To .40 Inch (5.1 To =10.0 Mm), 1 Pre-installed W/ Power Cord Models
Qty: 2	Metallic Liq-tight Connectors For .50 Inch Flexible Conduit (mat'l = Die Cast Zinc), Not Installed

5.1 Wiring Terminals and I/O Schematics

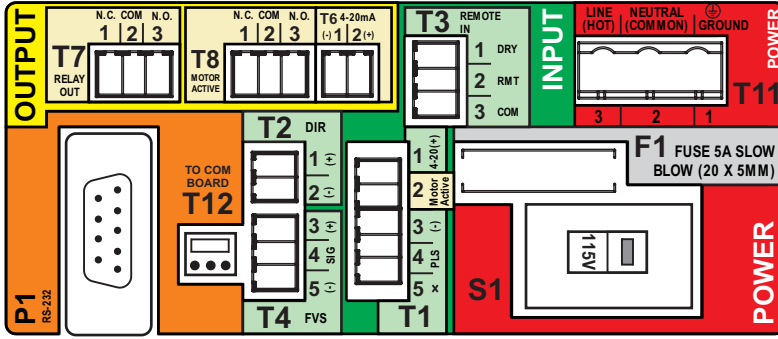

WARNING Risk of electric shock - All wiring must be insulated and rated 300V minimum.

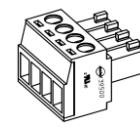

Terminals T1 Thru T8
Plug type
16 - 24 AWG

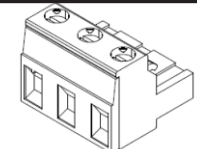

Power Input Terminal T11
Plug type
14 - 30 AWG

Shielded cables should be used on all input signal wires.

FUNCTION	TERM	PIN #	RATING	ELECTRICAL SP.	BLOCK DIAGRAM
INPUT: 4-20 mA	T1	1	(+) POSITIVE	120 OHM IMPEDANCE, NON POWERED LOOP	<p>Single or dual pump (series) input. Loop voltage must not exceed 24 Volts.</p>
	T1	3	(-) NEGATIVE		
INPUT: FREQUENCY, AC SINE WAVE, TTL, CMOS	T1	3	(-) NEGATIVE	0-1000 HZ MAX.	
	T1	4	(+) POSITIVE		
INPUT: FVS SYSTEM (FLOW VERIFICATION SENSOR) FV SENSOR ONLY	T4	3	(+) POSITIVE		
	T4	4	SIGNAL		
	T4	5	(-) NEGATIVE		
INPUT: FVS SYSTEM (FLOW VERIFICATION SENSOR) FS or FP MICRO-FLO FLOW METER ONLY	T4	4	SIGNAL		
	T4	5	(-) NEGATIVE		
	T4	5	(-) NEGATIVE		
INPUT: REMOTE START / STOP (DRY CONTACT C.)	T3	1	(+) POSITIVE	NO VOLTAGE	<p>NOTE: USE ONLY DRY CONTACT FOR REMOTE S/S WHEN USING 4-20mA INPUT</p>
	T3	2	(-) NEGATIVE		
INPUT: REMOTE START / STOP (WET CONTACT C.)	T3	2	(+) POSITIVE	6 TO 30 VOLT DC 1 AMP MAX.	
	T3	3	(-) NEGATIVE		
OUTPUT: 4-20 mA	T6	2	(+) POSITIVE	120 OHM RESISTANCE ACTIVE LOOP	
	T6	1	(-) NEGATIVE		
OUTPUT: RELAY, 3 AMP	T7	1	NORM. CLOSED	Form C 3 AMP MAX AT 250 VAC, 3 AMP MAX AT 30 VOLT DC	
	T7	2	COMMON		
	T7	3	NORM. OPEN		
OUTPUT: OPEN COLLECTOR MOTOR ACTIVE	T1	2	SIGNAL	5 TO 24 VDC	<p>CLOSED WHILE MOTOR IS ENERGIZED</p>
	T1	3	COMMON		
OUTPUT: MOTOR ACTIVE (CONTACT CLOSURE)	T8	1	NORM. CLOSED	Form C 1 AMP MAX AT 125 VAC, 0.8 AMP MAX AT 30 VOLT DC	
	T8	2	COMMON		
	T8	3	NORM. OPEN		
INPUT: POWER	T11	1	GROUND	115V OR 230V AC MANUAL SWITCH 50 / 60 HZ 100W	
	T11	2	NEUTRAL		
	T11	3	LINE (HOT)		
FUSE	F1	N/A	5 AMP	5A SLOW BLOW (20 X 5MM)	

Note: T2 terminal not used.

6.0 How to Operate FLEXFLO® - Control Pad

Press and release
 To select Run Mode
 Mode 1: Manual
 Mode 2: 4-20mA input
 Mode 3: Frequency input
 Mode 4: Pulse / Batch

Press and Hold
 To configure selected Mode
 Mode 0: Setup
 Mode 1: Manual
 Mode 2: 4-20mA input
 Mode 3: Frequency input
 Mode 4: Pulse / Batch

Press and release
 To prime pump (60 seconds)

Press and hold
 To change rotor direction
 clockwise or counterclockwise

Important: Hold button down to trigger rotor reversal



Press and release
 To view tube life timer in hours.

Press and release
 To scroll through menu options in Setup mode.
 To increase value while in programming mode.
 Press UP arrow to increase pump speed (output) in Manual mode (Mode 1).

Press and release
 To Start pump.
 To begin listening (reacting) to external signals.

Press and release
 To Stop pump.

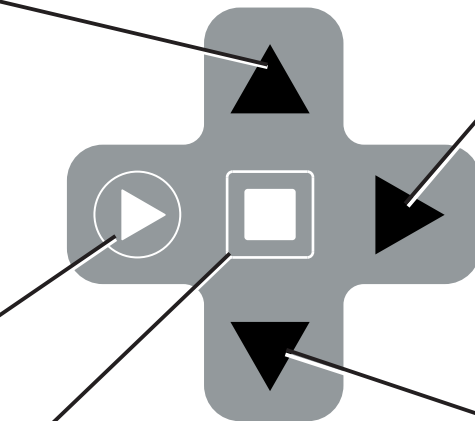

Press and release
 To scroll through menu options in Setup mode.
 To scroll through pump speed (output) and current incoming signals in run modes:
 Mode 2, Mode 3, & Mode 4

Press and release
 To scroll through menu options in Setup mode.
 To decrease value while in programming mode.
 Press DOWN arrow to decrease pump speed (output) in Manual mode (Mode 1).

6.1 Mode Descriptions

Mode 0 - Setup

Press and Hold to configure:

- Remote Start / Stop
- TFD (Tube Failure Detection) sensitivity
- FVS (Flow Verification Sensor) time delay - requires sensor
- 4-20 mA output

Mode 0



Mode 1 - Manual

Run pump locally by selecting pump speed (1 - 100%).

- Control speed by using up or down arrows after start button is pressed.
- Control speed by entering Mode 1 setup and selecting desired pump speed (1 - 100%)

Mode 1

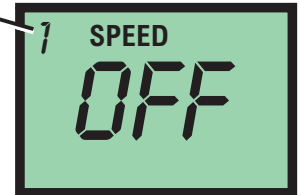

Mode 2 - 4-20 mA Input Signal

Run pump remotely via external 4-20 mA signal.

- Press and Hold "Select Run Mode" button with Mode 2 selected to configure settings.
- Select Mode 2 and press START button to allow pump to be controlled by external 4-20mA signal.

Mode 2

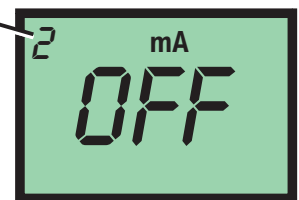

Mode 3 - Frequency (Hz) Input Signal

Run pump remotely via external high frequency (Hz) signal.

- Press and Hold "Select Run Mode" button with Mode 3 selected to configure settings.
- Select Mode 3 and press START button to allow pump to be controlled by external frequency (Hz) signal.

Mode 3

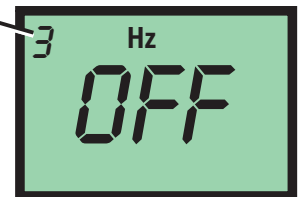

Mode 4 - Pulse Batch Input Signal (low speed pulse)

Run pump remotely via external low speed pulse signal.

- Press and Hold "Select Run Mode" button with Mode 4 selected to configure settings.
- Select Mode 4 and press START button to allow pump to be controlled by external low speed pulse signal.

Mode 4

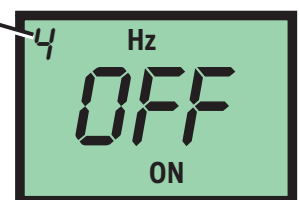

7.0 Mode 0 - Set Remote Start / Stop

Used to remotely start and stop pump using a dry contact closure signal.
When activated; CLOSE = START and OPEN = STOP.

Set to NO = Remote Start / Stop is disabled
Set to Yes = Remote Start / Stop is enabled

Can be used with external foot pedal, PLC, contact closure or other similar external devices.

Default setting = No (disabled)

Step 1

Press and release STOP button

Note: Mode cannot be changed while pump is in running.

Press and release SELECT RUN MODE button multiple times until Mode 0 is selected.

Mode 0



Step 2

With Mode 0 selected, press and hold SELECT RUN MODE button until 'Remote' icon begins flashing.

Default setting 'NO' will also be visible when entering remote start / stop setup.

Note: If 'YES' had been selected previously, then 'YES' will be displayed on screen.

Mode 0

Remote Icon



Step 3

Press and release DOWN arrow to change setting to 'YES.'
To change setting back to 'NO' press and release UP arrow.

Mode 0



Step 4

After you've made your selection, press and release RIGHT arrow button. This saves your setting.
You can now modify other settings in Mode 0 or you can exit Setup by pressing and holding SELECT RUN MODE button for a few seconds until you return to Run screen.

Mode 0



Running pump with Remote Start / Stop enabled, 'REMOTE' icon will always be visible on lower left side of screen.
Pump will display 'STBY' (standby) if pump is in stop mode via contact closure signal. **Please use caution in this mode, pump can start at anytime. If you must perform maintenance to pump, press and release STOP button.**

7.1 Mode 0 - Set TFD Sensitivity

Flex-Pro pump is equipped with a Tube Failure Detection (TFD) system which is designed to stop pump in event pump tube should rupture and chemical enters pump head. This patented system is capable of detection presence of a large number of chemicals including Sodium Hypochlorite (chlorine), Hydrochloric (muriatic) Acid, Sodium Hydroxide, and many others.

Minimum and Maximum setting = 78 % to 100%

Default Setting = 78% (78% is recommended; triggers with most water treatment chemicals without false alarms)

Important: 100% sensitivity setting may trigger false alarm by washdown or rain. 100% setting is only recommended when absolutely necessary.

Step 1

Press and release STOP button

Note: Mode cannot be changed while pump is in running.

Press and release SELECT RUN MODE button multiple times until Mode 0 is selected.

Mode 0



Step 2

With Mode 0 selected, press and hold SELECT RUN MODE button until 'Remote' icon begins flashing.

This indicates that you've entered Setup menu.

Mode 0

Remote
Icon



Step 3

Press and release RIGHT arrow button to scroll through menu until you see TFD icon.

If you pass TFD screen, continue to press and release RIGHT arrow button until TFD icon appears.

Mode 0



Step 4

TFD icon will appear for 1 second, followed by numbers.

Numbers indicate sensitivity value of TFD.

Press and release UP arrow button to increase sensitivity value.

Press and release DOWN arrow button to decrease sensitivity value.

Mode 0



Step 5

After you've made your selection, press and release RIGHT arrow button. This saves your setting.

You can now modify other settings in Mode 0 or you can exit Setup by; press and hold SELECT RUN MODE button for a few seconds until you return to Run screen.

Mode 0



Confirm chemical detection - To determine if your chemical will be detected by system, remove pump tube and rotor. Place a small amount of chemical in bottom of pump head - just enough to cover sensors. Turn on pump. If TFD system detects chemical, pump will stop after two seconds and TFD alarm screen will display. Press STOP button to clear alarm.

7.2 Mode 0 - Set FVS (flow verification system)

Flow verification sensor sold separately.

Flow verification system is designed to stop pump in an event sensor does not detect flow during pump operation. Indicating an empty chemical tank, clogged injection fitting, loose tubing connection, etc.

To allow pump to clear any gasses that may have accumulated over time, an alarm delay time value from 1 to 255 seconds must be programmed.

Note: An alarm delay of 000 seconds disables FVS system.

Step 1

Press and release STOP button

Note: Mode cannot be changed while pump is in running.

Press and release SELECT RUN MODE button multiple times until Mode 0 is selected.

Mode 0



Step 2

With Mode 0 selected, press and hold SELECT RUN MODE button until 'Remote' icon begins flashing.

This indicates that you've entered Setup menu.

Mode 0

Remote
Icon



Step 3

Press and release RIGHT arrow to scroll through menu until you see FVS icon.

If you pass FVS screen, continue to press and release RIGHT arrow button until FVS icon appears.

Mode 0

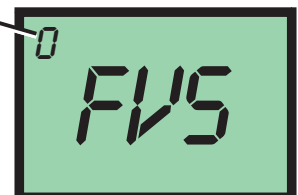

Step 4

FVS icon will appear for 1 second, followed by numbers.

These numbers indicate delay time setting for FVS.

Select a delay time in seconds. Delay time is amount of time pump will wait to receive a pulse from sensor until an alarm it triggered.

A delay time of 00 deactivates FVS feature.

Mode 0



Step 5

After you've made your selection, press and release RIGHT arrow button. This saves your setting.

You can now modify other settings in Mode 0 or you can exit Setup by; press and hold SELECT RUN MODE button for a few seconds until you return to Run screen.

Mode 0



Time-out - Flex-Pro pumps have a time-out setting of 20 seconds while in configuration menus. If built-in timer exceeds 20 seconds without a button being pressed, then pump will exit configuration menu. Changes will only be saved after RIGHT arrow button is pressed and released.

7.2 Mode 0 - Set FVS (flow verification system) - Continued

Flow Verification Sensor is designed to give you two installation options.

Sensor can be installed:

- Directly on pumphead of M2 pump, suction side.
- Anywhere on suction side of M2 pump.

Wiring for sensor can be connected directly to an M2 pump. Pump will stop pumping if sensor detects no flow. A relay will then close allowing for remote alarm indication or initiation of a back-up injector pump. **Install FVS Flow Sensor** - Flow Verification Sensor should be installed on inlet (suction) side of pump tube. Sensor includes a PVC tubing insert, located inside sensors female thread connection, that is designed to seal sensor onto pump tube inlet adapter. Thread sensor onto pump tube until tubing insert is snug against pump tube inlet fitting - do not over-tighten.

Sensor Model Number	Published Flow Range	Actual Working Range with Flex-Pro Pump
	ML/Min	ML/Min
FV-100	30-300	30-200
FV-200	100-1000	50-900
FV-300	200-2000	100-1800
FV-400	300-3000	300-3000
FV-500	500-5000	500-5000
FV-600	700-7000	700-7000



Confirm FVS flow range - Flow Verification Sensor (FVS) will only function within its operating range. See chart for available ranges.

Example: Sensor model FV-100 has an operation range of 30-300 ml/min when used as a flowmeter. However, due to pressure drop across sensor, pump's suction capability is limited to 14.7 psi. When used as a Flow Verification Sensor with a peristaltic pump, effective operating range is reduced to 30-200 ml/min.

NOTE: If pump output is less than 30 ml/min, sensor will not detect chemical and a signal will not be sent to pump, resulting in an alarm condition.

NOTE: For low viscosity (water-like) fluids only. Consult factory if attempting to use with viscous fluids.

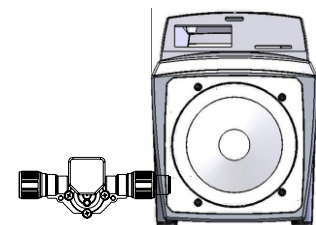

7.3 Mode 0 - Set 4-20mA Output

Sends a configurable 4-20 mA signal, based on pump rotor speed, to an external device. This feature can be used to control other pumps (in sync / proportionally), data logging systems, and other external devices for plant automation.

Default setting: Minimum Speed = 4 mA signal output
 Maximum Speed = 20 mA signal output

Set to NO = disabled
 Set to Yes = enabled

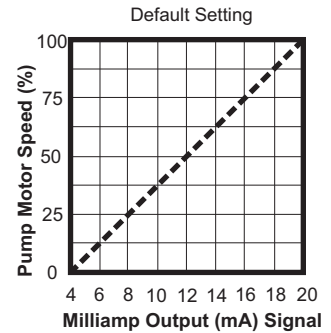

Step 1

Press and release STOP button
 Note: Mode cannot be changed while pump is in running.
 Press and release SELECT RUN MODE button multiple times until Mode 0 is selected.

Step 2

With Mode 0 selected, press and hold SELECT RUN MODE button until 'Remote' icon begins flashing.
 This indicates that you've entered Setup menu.

Step 3

Press and release RIGHT arrow to scroll through menu until you see 4-20 mA icon.
 To select Yes, press and release DOWN arrow.
 To select No, press and release UP arrow.
 To begin configuring values, select Yes.
 Then press and release RIGHT arrow.

Step 4

Minimum pump speed will be displayed.
 To increase value, press and release UP arrow.
 To decrease value, press and release DOWN arrow.
 To save value, press and release RIGHT arrow.

Time-out - Flex-Pro pumps have a time-out setting of 20 seconds while in configuration menus. If built-in timer exceeds 20 seconds without a button being pressed, then pump will exit configuration menu. Changes will only be saved after RIGHT arrow button is pressed and released.

7.3 Mode 0 - Set 4-20mA Output - Continued

Step 5

Output signal at minimum speed will now be displayed.
 To increase value, press and release UP arrow.
 To decrease value, press and release DOWN arrow.
 To save value, press and release RIGHT arrow.

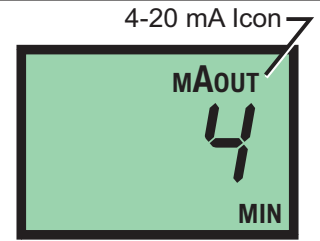

Step 6

Maximum pump speed will be displayed.
 To increase value, press and release UP arrow.
 To decrease value, press and release DOWN arrow.
 To save value, press and release RIGHT arrow.

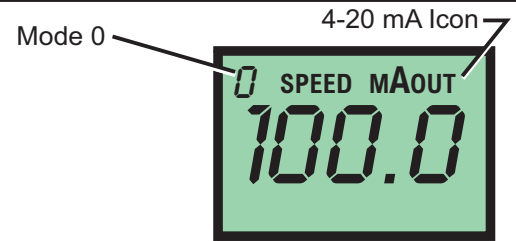

Step 7

Output signal at maximum speed will now be displayed.
 To increase value, press and release UP arrow.
 To decrease value, press and release DOWN arrow.
 To save value, press and release RIGHT arrow.

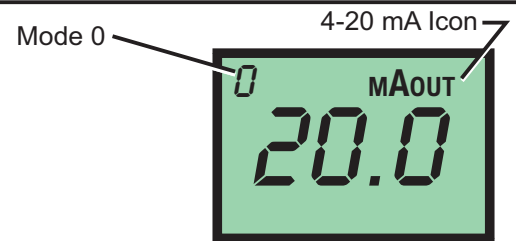

Step 8

You can now modify other settings in Mode 0 or you can exit Setup by; press and hold SELECT RUN MODE button for a few seconds until you return to Run screen.

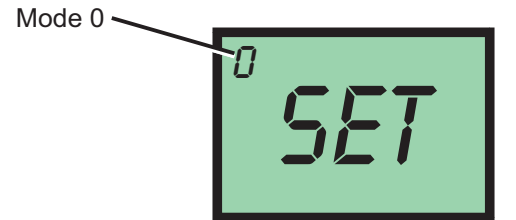

Example 1

0% Pump Output = 4 mA
 100 % Pump Output = 20 mA

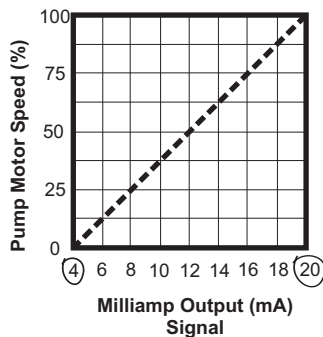

Example 2

0% Pump Output = 4 mA
 50% Pump Output = 16 mA

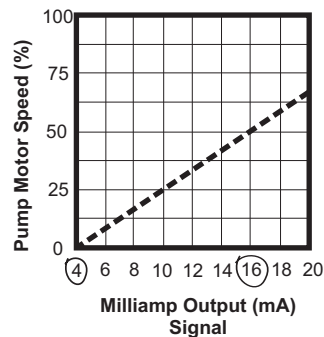

7.4 Mode 0 - Set Flow Rate Display

Display pump output Flow Rate. Default setting: mL/m (Milliliter per minute)

Available settings: none, mL/m, Oz/m, L/h, G/h

Before you begin configuring your Flow Rate, please perform a volumetric test on your pump. Please see section 20.0 Volumetric Test - Calibration (page 36)

Log your Flow Rate using Milliliters Per Minute here _____ mL/m.

Step 1

Ensure pump is stopped and LCD reads "OFF."

Note: Mode cannot be changed while pump is in running.

Press and release STOP button if pump is running.

Press and release MODE button multiple times until Mode 0 is selected.

Mode 0



Step 2

With Mode 0 selected, press and hold MODE button until 'Remote' icon begins flashing.

This indicates that you've entered Setup menu.

Mode 0

Remote Icon



Step 3

Press and release RIGHT ARROW button to scroll through menu until you see RATE display for 2 seconds.

Arrow pointing at Flow Rate will begin flashing.

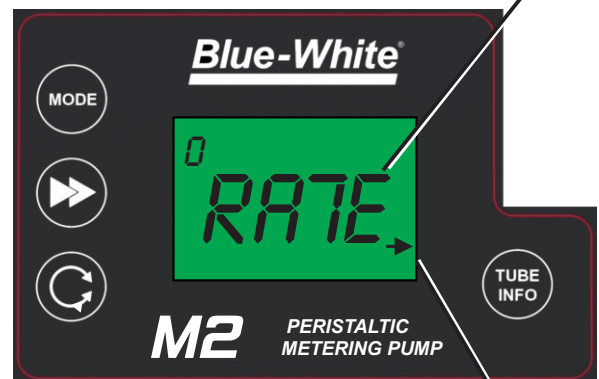

Flow Rate Arrow

Step 4

Press and release UP button or DOWN button to scroll through Flow Rate units.

Available Flow Rate units:

- None, mL/m, Oz/m, L/h, G/h

Select desired Flow Rate unit. Then press and release RIGHT ARROW button to save selection.

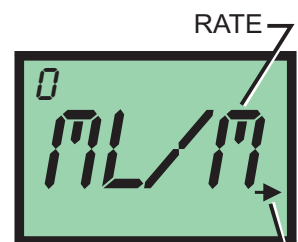

Flow Rate Arrow

7.4 Mode 0 - Set Flow Rate Display - Continued

Step 5

LCD will flash "FLOW" then "MAX" then "mL/m" (or your selected Flow Rate unit), each for 2 seconds.

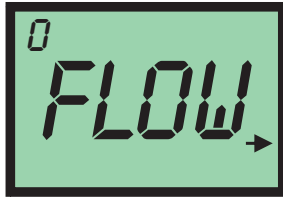

Displayed 2 sec.

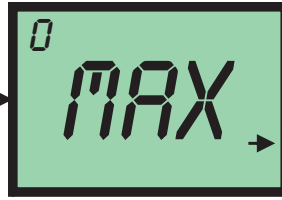

Displayed 2 sec.

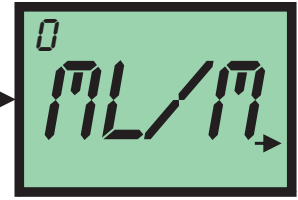

Displayed 2 sec.

Step 6

LCD will show four digits (default is 2650 mL/m).
Use this screen to input maximum Flow Rate for your pump in Milliliters Per Minute.
To increase value, press and release UP arrow.
To decrease value, press and release DOWN arrow.
To save value, press and release RIGHT ARROW button.



Default: 2650 mL/m

Important Note: At this step, you are going to input your pumps max Flow Rate in mL/m. While pump is in normal operation, Flow Rate unit you've selected in Step 4 will be displayed on LCD.

Step 7

You can now modify other settings in Mode 0 or you can exit Setup by; press and hold MODE button for a few seconds until you return to Run screen.

Mode 0



7.4.1 Operation Screens Displaying Flow Rate

Runtime Screen Shot 1

While pump is running, press and release RIGHT ARROW button repeatedly until Flow Rate arrow is displayed pointing at Flow Rate.

LCD will automatically scroll (loop) between actual Flow Rate and units of measure.

Flow value displayed for 4 seconds.
Units of measure displayed for 2.5 seconds.



Displayed 4 sec.



Displayed 2.5 sec.

8.0 Mode 1 - Manual Operation

Used to manually control speed of pump.

Use UP and DOWN arrows to adjust speed while pump is running.

To select exact run speed, follow steps below.

Step 1

Press and release STOP button

Note: Mode cannot be changed while pump is in running.

Press and release SELECT RUN MODE button multiple times until Mode 1 is selected.

Mode 1

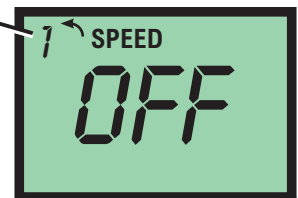

Step 2

With Mode 1 selected, press and hold SELECT RUN MODE button until 'Speed' icon begins flashing.

This indicates that you've entered Setup menu.

Mode 1

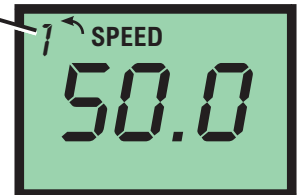

Step 3

Current pump speed will be displayed.

To increase value, press and release UP arrow.

To decrease value, press and release DOWN arrow.

To save value, press and hold SELECT RUN MODE button until 'Speed' icon stop flashing.

Mode 1



Step 4

Pump will now operate at your pre-configured speed.

Press and release START button to start pump.

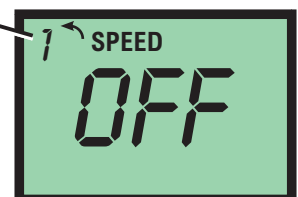

Press and release STOP button at anytime to stop pump.

Mode 1

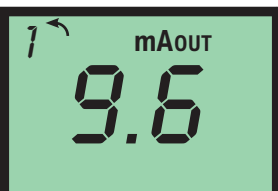

With pump operating in manual mode (Mode 1), pump speed can be changed at anytime by using UP or DOWN arrows during operation.

8.1 Mode 1 - Manual Operation Screen Shots

<p>Runtime Screen Shot 1</p> <p>Display motor speed percentage. Pump Running in Manual Operation</p>	
<p>Runtime Screen Shot 2</p> <p>Display 4-20mA output Press and release RIGHT arrow to view mA output value in real-time.</p> <p><i>Please note:</i> 4-20mA output must be enabled in Mode 0 (see page 16).</p>	
<p>Runtime Screen Shot 3</p> <p>Display motor speed percentage. Press and release RIGHT arrow to view percentage of motor speed.</p>	
<p>Runtime Screen Shot 4</p> <p>Display tube life timer. Press and release TUBE INFO button.</p> <p>Displays amount of total runtime hours on currently installed tube. Time will be displayed in hours. Timer will be display for approximately 5 seconds before returning to previous runtime screen.</p>	

9.0 Mode 2 - 4-20mA Input Operation

Used to remotely control pump with an incoming 4-20 mA signal.

Default setting: 4 mA signal = 0.0% motor speed
 20 mA signal = 100.0% motor speed

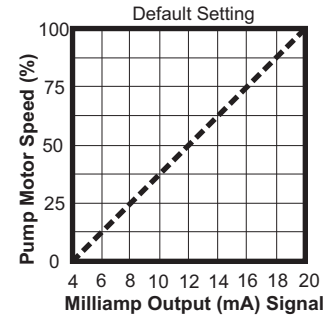

Step 1

Press and release STOP button
 Note: Mode cannot be changed while pump is in running.
 Press and release SELECT RUN MODE button multiple times until Mode 2 is selected.

Mode 2

Step 2

With Mode 2 selected, press and hold SELECT RUN MODE button until 'Speed' icon begins flashing.
 This indicates that you've entered Setup menu.

Mode 2

Step 3

Minimum pump speed will be displayed.
 To increase value, press and release UP arrow.
 To decrease value, press and release DOWN arrow.
 To save value, press and release RIGHT arrow.

Mode 2

Step 4

mA value linked to minimum pump speed will be displayed.
 To increase value, press and release UP arrow.
 To decrease value, press and release DOWN arrow.
 To save value, press and release RIGHT arrow.

Mode 2

Step 5

Maximum pump speed will be displayed.
 To increase value, press and release UP arrow.
 To decrease value, press and release DOWN arrow.
 To save value, press and release RIGHT arrow.

Mode 2

Time-out - Flex-Pro pumps have a time-out setting of 20 seconds while in configuration menus. If built-in timer exceeds 20 seconds without a button being pressed, then pump will exit configuration menu. Changes will only be saved after RIGHT arrow button is pressed and released.

9.0 Mode 2 - 4-20mA Input Operation - Continued

Step 6

mA value linked to maximum pump speed will now be displayed.
 To increase value, press and release UP arrow.
 To decrease value, press and release DOWN arrow.
 To save value, press and release RIGHT arrow.

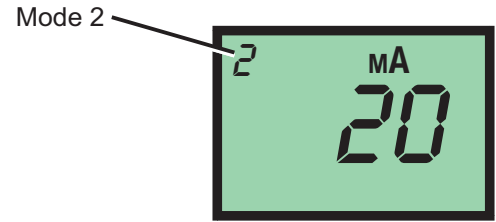

Step 7

To exit Setup, press and hold SELECT RUN MODE button for a few seconds until you return to Run screen.

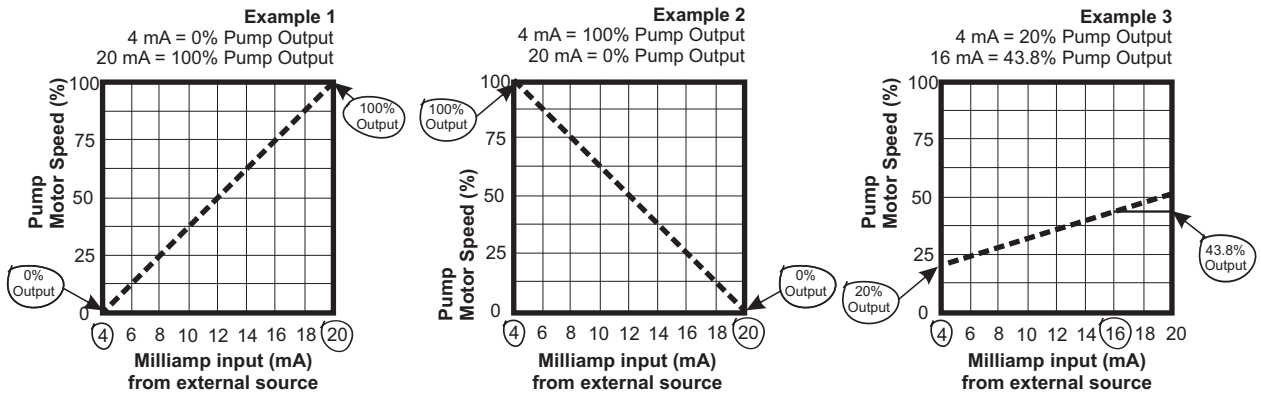
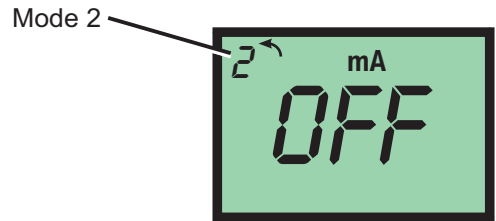

9.1 Mode 2 - 4-20mA Input Screen Shots

Runtime Screen Shot 1

Display **motor speed percentage**.
 Pump Running in 4-20mA Input Operation

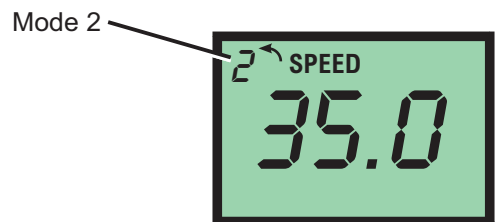

Runtime Screen Shot 2

Display current 4-20mA input signal
 Press and release RIGHT arrow to view **mA input** value in real-time.

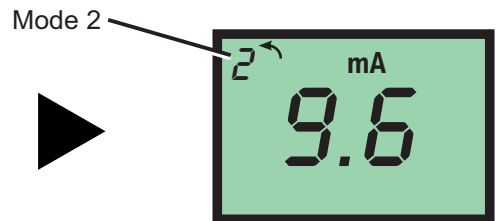

Runtime Screen Shot 3

Press and release RIGHT arrow again to view **mA output** value in real-time.
 Press and release RIGHT arrow again to view **motor speed percentage**, as in Screen Shot 1.

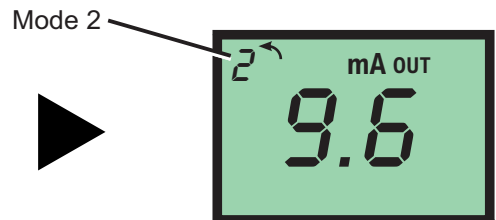

10.0 Mode 3 - Frequency Input (Hz) Operation

Used to remotely control pump with an incoming high speed frequency signal. Typically used with flow meters or other external devices.

Default setting: 0 Frequency (Hz) = 0% motor speed
 1000 Frequency (Hz) = 100% motor speed

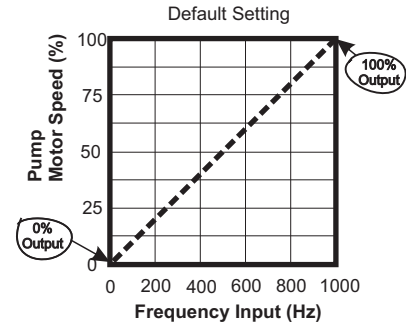

Step 1

Press and release STOP button
 Note: Mode cannot be changed while pump is in running.
 Press and release SELECT RUN MODE button multiple times until Mode 3 is selected.

Mode 3

Step 2

With Mode 3 selected, press and hold SELECT RUN MODE button until 'Speed' icon begins flashing.
 This indicates that you've entered Setup menu.

Mode 3

Step 3

Pump speed at minimum Frequency will be displayed.
 To increase value, press and release UP arrow.
 To decrease value, press and release DOWN arrow.
 To save value, press and release RIGHT arrow.

Mode 3

Step 4

Minimum Frequency (Hz) value will be displayed.
 To increase value, press and release UP arrow.
 To decrease value, press and release DOWN arrow.
 To save value, press and release RIGHT arrow.

Mode 3

Time-out - Flex-Pro pumps have a time-out setting of 20 seconds while in configuration menus. If built-in timer exceeds 20 seconds without a button being pressed, then pump will exit configuration menu. Changes will only be saved after RIGHT arrow button is pressed and released.

10.0 Mode 3 - Frequency Input (Hz) Operation - Continued

Step 5

Pump speed at maximum Frequency will be displayed.
 To increase value, press and release UP arrow.
 To decrease value, press and release DOWN arrow.
 To save value, press and release RIGHT arrow.

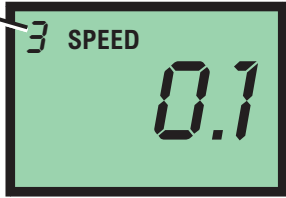

Mode 3

Step 6

Maximum Frequency value will now be displayed.
 To increase value, press and release UP arrow.
 To decrease value, press and release DOWN arrow.
 To save value, press and release RIGHT arrow.



Mode 3

Step 7

To exit Setup, press and hold SELECT RUN MODE button for a few seconds until you return to Run screen.

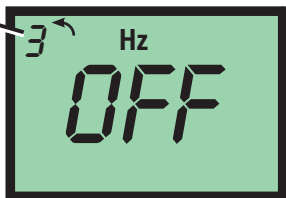

Mode 3

Examples:

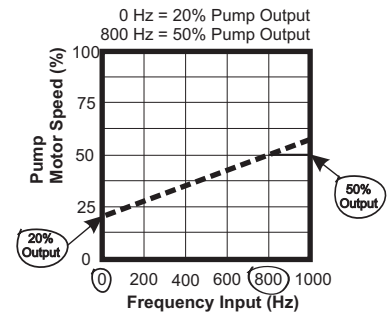
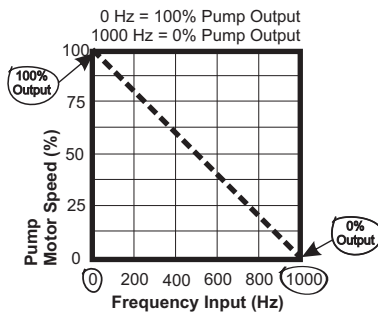
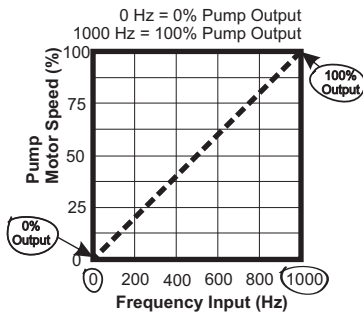

Example #1, Ultrasonic flow meter

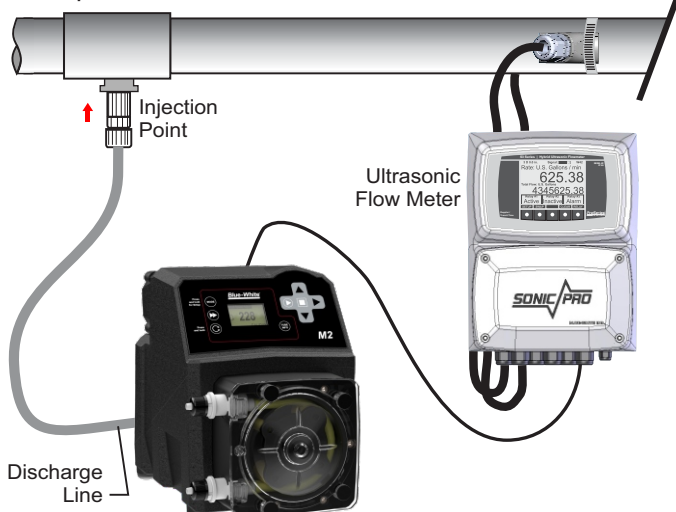

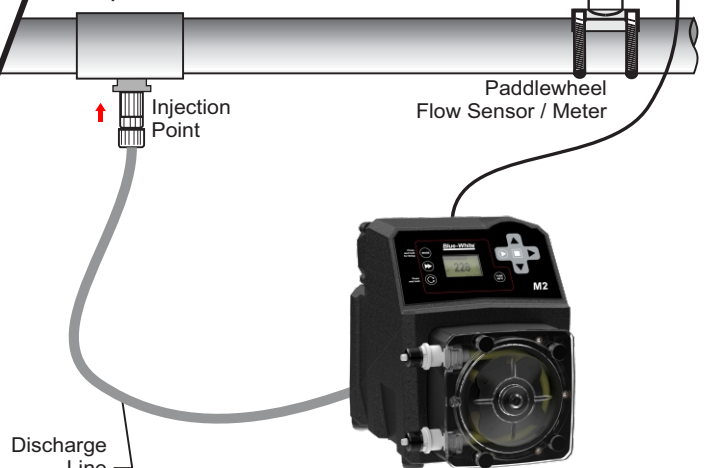

Example #2, Paddlewheel flow meter



11.0 Mode 4 - Pulse Batch (low speed pulse) Operation

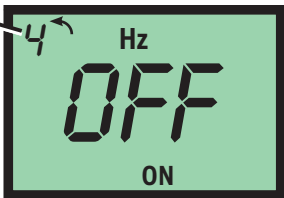

Used to remotely control pump with an incoming pulse signal. Can be used with an external foot pedal, a water meter, a PLC, contact closure, or other low speed pulse devices.

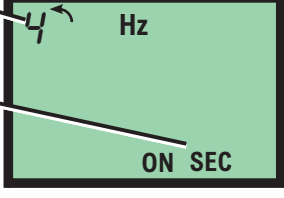
Default setting: 1 Pulse = 100% motor speed for 2.5 seconds

<p>Step 1</p> <p>Press and release STOP button Note: Mode cannot be changed while pump is in running. Press and release SELECT RUN MODE button multiple times until Mode 4 is selected.</p>	<p>Mode 4</p> 
<p>Step 2</p> <p>With Mode 4 selected, press and hold SELECT RUN MODE button until 'On' icon begins flashing. This indicates that you've entered Setup menu.</p>	<p>Mode 4</p> 
<p>Step 3</p> <p>Pump on-time will be displayed in either MIN (minutes) or SEC (seconds). To increase value, press and release UP arrow. To decrease value, press and release DOWN arrow. To save value, press and release RIGHT arrow.</p>	<p>Mode 4</p> 
<p>Step 4</p> <p>MIN (minutes) or SEC (seconds) will be displayed in lower right hand corner. This value will be linked to Pump on-time number in previous screen. To change this setting, press and release either UP arrow or DOWN arrow. To save value, press and release RIGHT arrow.</p>	<p>Mode 4</p> <p>MIN or SEC</p> 

Time-out - Flex-Pro pumps have a time-out setting of 20 seconds while in configuration menus. If built-in timer exceeds 20 seconds without a button being pressed, then pump will exit configuration menu. Changes will only be saved after RIGHT arrow button is pressed and released.

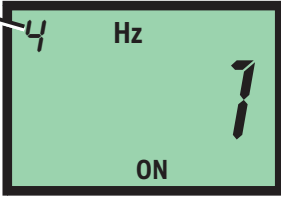
11.0 Mode 4 - Pulse Batch (low speed pulse) Operation - Continued

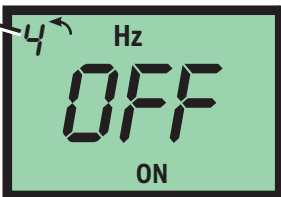
<p>Step 5</p> <p>Number of pulses to trigger pump start will be displayed. To increase value, press and release UP arrow. To decrease value, press and release DOWN arrow. To save value, press and release RIGHT arrow.</p>	<p>Mode 4 →</p> 
<p>Step 6</p> <p>Pump speed during on-time will now be displayed. Pump will run at this speed after selected number of pulses is reached from previous menu. To increase value, press and release UP arrow. To decrease value, press and release DOWN arrow. To save value, press and release RIGHT arrow.</p>	<p>Mode 4 →</p> 
<p>Step 7</p> <p>To exit Setup, press and hold SELECT RUN MODE button for a few seconds until you return to Run screen.</p>	<p>Mode 4 →</p> 

11.1 Mode 4 - Pulse Batch Operation Screen Shots

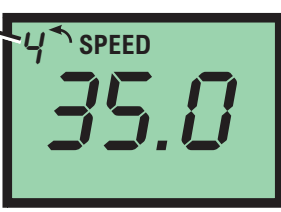
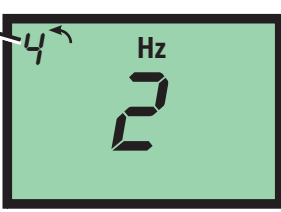
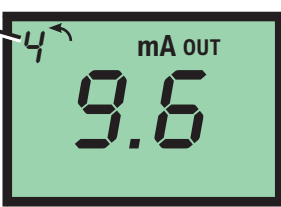
<p>Runtime Screen Shot 1</p> <p>Display motor speed percentage. Pump Running in Pulse Batch Operation</p>	<p>Mode 4 →</p> 
<p>Runtime Screen Shot 2</p> <p>Display current number of pulses received Press and release RIGHT arrow to view number of pulses received in real-time.</p>	<p>Mode 4 →</p> 
<p>Runtime Screen Shot 3</p> <p>Press and release RIGHT arrow again to view mA output value in real-time. Press and release RIGHT arrow again to view motor speed percentage, as in Screen Shot 1.</p>	<p>Mode 4 →</p> 

12.0 Pump Tube Timer

Flex-Pro has a built in Pump Tube Timer. Timer starts when rotor is rotating and stops when rotor is idle.

To view current Pump Tube Timer value, press and hold START button, then press and release DOWN arrow.

Tube Timer screen will appear. Screen will display current Pump Tube Time in run-time hours. Tube Timer screen will display for 5 seconds and then switch back to previous operating display screen.



While displayed, press START button twice to reset Pump Tube Timer to zero.

When replacing pump tube, pump will ask you if you'd like to reset Pump Tube Timer. If you choose YES, screen will display current Pump Tube Time for 5 seconds before timer is reset to zero.

Tube Life Timer

Display tube life timer.
Press and release TUBE INFO button.

Displays amount of total runtime hours on currently installed tube.
Time will be displayed in hours.
Timer will be display for approximately 5 seconds before returning to previous runtime screen.

13.0 TFD (Tube Failure Detection)

Flex-Pro is equipped with a *Tube Failure Detection* System which is designed to stop pump and provide an output alarm in event pump tube should rupture and chemical enters pump head. Pump will detect a chemical with a conductivity reading greater than 500 microsiemens. Chemicals with a conductivity of less than 500 microsiemens will not be detected.

This patented system is capable of detecting presence of a large number of chemicals including Sodium Hypochlorite (Chlorine), Hydrochloric (muriatic) Acid, Sodium Hydroxide, and many others. System will not be triggered by water (rain, condensation, etc.) or silicone oil (roller and tubing lubricant).

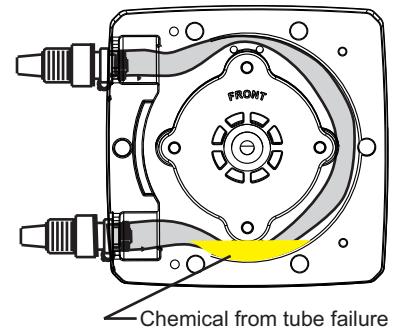

If system has detected chemical, pump tube must be replaced and pump head and roller assembly must be thoroughly cleaned. Failure to clean roller assembly will void warranty.

If TFD alarm occurs, pump will stop, close an alarm output, and screen will flash TFD with an alarm icon.

Confirm Chemical Detection

To determine if your chemical will be detected by system, remove pump head cover and pump tube and roller assembly.

Place a small amount of chemical in bottom of pump head - just enough to cover sensors. Replace pump head cover only.

Turn on pump (press START). If TFD system detects chemical, pump will stop after a two second confirmation period and TFD Alarm screen will display. If TFD system does not detect chemical, pump will continue to run after confirmation period.

Carefully clean chemical out of pump head being sure to remove all traces of chemical from sensor probes. Replace roller assembly and tubing. Replace pump head cover. Press START button to clear alarm condition and restart pump.

14.0 Alarm Relay

Pump has a built in 3 amp alarm output relay. Relay is pre-configured to energize on tube failure detection (TFD) and on Flow Verification Sensor (FVS).

A Flow Verification Sensor must be installed and configured for relay to trigger on no-flow conditions.

15.0 Reverse Rotor Rotation

CAUTION



Prior to service, pump clean water through pump and suction / discharge line to remove chemical.

CAUTION



Always wear protective clothing, face shield, safety glasses and gloves when working on or near your metering pump. Additional precautions should be taken depending on solution being pumped. Refer to MSDS precautions from your solution supplier.

Reverse rotation of pump; press and hold REVERSE ROTATION button until rotor begins rotating in opposite direction. This process can be used for many reasons throughout various industries.

Two reasons for reversing current rotor rotation; to purge chemical from tubing and to extend tube life.

Plan ahead before reversing rotor rotation. If check valves are installed, make necessary arrangements to allow back flow.

CAUTION



Failure to install check valves in their proper flow direction can cause excess pressure (PSI_g) build up in system and can result in tube rupture. Always use extreme caution and ensure proper connections when using this feature.

If your desire is to simply extend tube life:

Typically tubing fails on outlet side (pressure side) of tube assembly in pump head.

Reversing rotation, moves outlet side (pressure side) to opposite side of tube assembly, greatly increasing tube life.

Stop pump before tube failure occurs.



Disconnect power from pump. Carefully purge any pressure in discharge line of pump. Disconnect suction end tubing and discharge end tubing from pump head tubing.

IMPORTANT! Swap sides of suction (inlet) and discharge (outlet) tubing. No need to remove Pump Head Cover.

Double check all connections before starting pump.

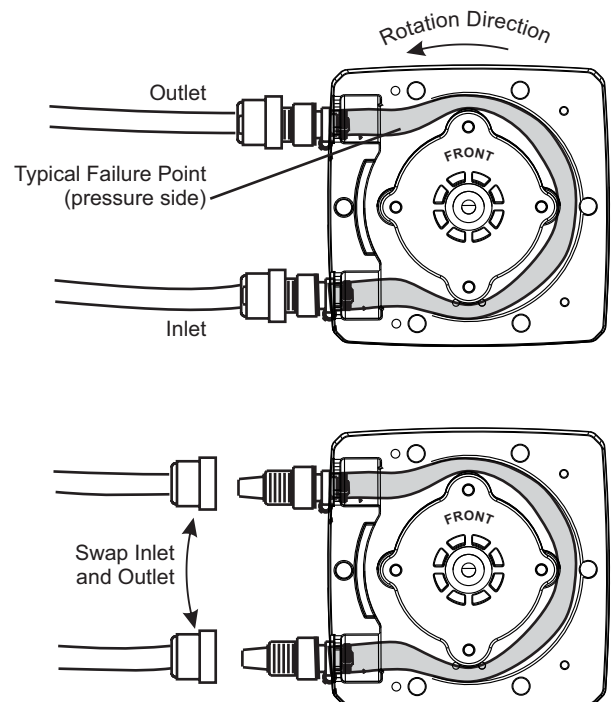

16.0 Tube Replacement

CAUTION ⚠	Prior to service, pump clean water through pump and suction / discharge line to remove chemical.
CAUTION ⚠	Always wear protective clothing, face shield, safety glasses and gloves when working on or near your metering pump. Additional precautions should be taken depending on solution being pumped. Refer to MSDS precautions from your solution supplier.
CAUTION ⚠	Use provided Tube Installation Tool to leverage tubing into pump head, <u>NOT YOUR FINGERS</u> .
CAUTION ⚠	Use extreme caution when replacing pump tube. Be careful of your fingers and <u>DO NOT place fingers near rollers</u> .

16.1 Cover “CVR” and Tube Removal

Step 1

Wear protective clothing, face shield, safety glasses and gloves during tube replacement.

Relieve (remove) system pressure on discharge and suction side of pump. Failure to do so will cause solution to squirt when disconnecting tube connections. **SAFETY FIRST, REMOVE PRESSURE...**

Disconnect system plumbing from pump tube adapters.



Step 2

Press and release STOP button.

Remove four black thumb screws from front of pump head cover. Turn screws counterclockwise to remove.

Remove pump head cover by pulling straight out.

Display will read “CVR” when pump cover is removed.

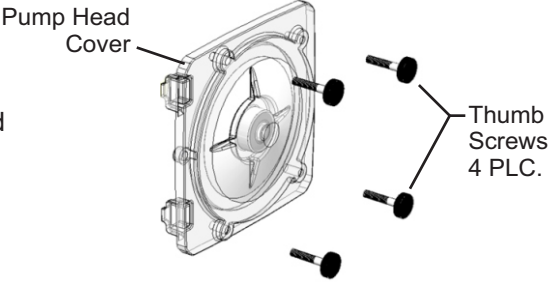

Step 3

With pump stopped, securely grab hold of suction side of tube adapter.

CAUTION! Keep fingers away from rollers and rotor.

Press and release START button to allow rotation of rotor.

Gently pull suction side tube adapter out, away from pump.



Step 4

Continue to pull suction side adapter out of pump head while rotor is in rotation.

Press and release STOP button.



Carefully pull discharge side of tube adapter out of pump head.

Dispose of used tubing properly.



16.2 Tube Installation

Before you begin. Thoroughly clean Pump Head and Rotor. Rotor can be removed by pulling straight out. After cleaning process, push Rotor back on shaft. See drawing below for proper assembly. **IMPORTANT!** Rotor direction; word “FRONT” on Rotor must face forward (front of pump).

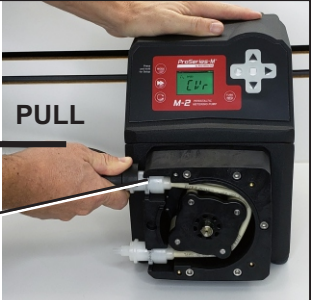
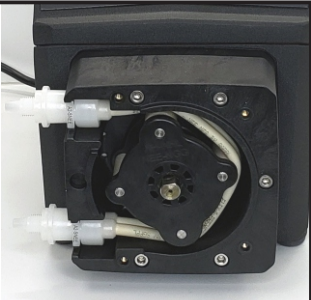
<p>Step 1</p> <p>Press and release stop button to ensure pump is stopped.</p> <p>With pump stopped, press suction side of tube adapter securely into pump head.</p> <p>Clip Tube Installation Tool to discharge side of tube adapter.</p> <p>Always keep fingers away from rollers and rotor.</p>	 <p>Installation Tool</p> <p>Suction side tube adapter</p>
<p>Step 2</p> <p>Your hand should only come in contact with installation tool.</p> <p>Press and release START button.</p> <p>Use installation tool to leverage tubing into pump head while rotor is rotating.</p>	 <p>Installation Tool</p>
<p>Step 3</p> <p>Continue to hold onto installation tool.</p> <p>Allow rotor to rotate a few times, this will stretch tubing out.</p> <p>After a few rotations, pull installation tool and tubing in direction of rotation.</p> <p>Press discharge side of tube adapter securely into pump head.</p>	 <p>PULL</p> <p>Discharge side tube adapter</p>
<p>Step 4</p> <p>Press and release STOP button on pump.</p> <p>Suction and discharge tube adapter ends should be securely held in place on pump head as illustrated in photo.</p> <p>Secure pump head cover to pump head using four black thumb screws.</p> <p>With cover secured properly. “CVR” will drop from display.</p>	

NOTE: If “CVR” remains on screen after cover is secured properly, please contact factory for or local service center for support.

www.blue-white.com/support

Tip! Apply silicone oil to outside of Flex-A-Thane tube for longer life.



Tube Installation Tool
90002-278

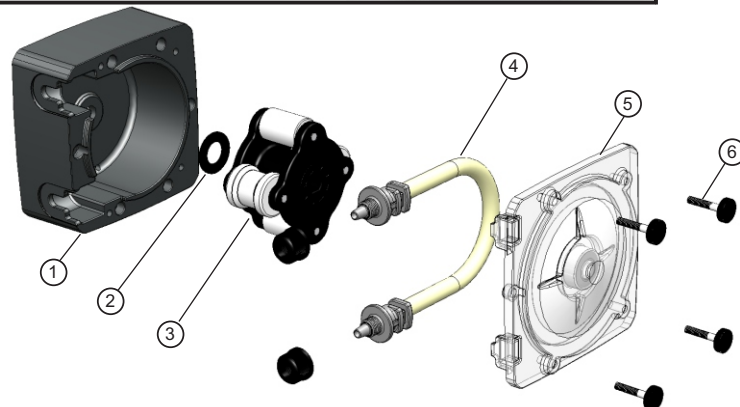

17.0 Pump Maintenance

CAUTION

Always wear protective clothing, face shield, safety glasses and gloves when working on or near your metering pump. Additional precautions should be taken depending on solution being pumped. Refer to MSDS precautions from your solution supplier.

Routine Inspection and Maintenance

Pump requires very little maintenance. However, pump and all accessories should be checked weekly. This is especially important when pumping chemicals. Inspect all components for signs of leaking, swelling, cracking, discoloration or corrosion. Replace worn or damaged components immediately.

Cracking, crazing, discoloration during first week of operation are signs of severe chemical attack. If this occurs, immediately remove chemical from pump. Determine which parts are being attacked and replace them with parts that have been manufactured using more suitable materials. Manufacturer does not assume responsibility for damage to pump that has been caused by chemical attack.

How to Clean and Lubricate Pump

Pump will require occasional cleaning. Amount will depend on severity of service.

- When changing pump tube assembly, pump head chamber, roller assembly and pump head cover should be wiped free of any dirt and debris.
- When changing pump tube assembly, wipe motor shaft with clean towel. Apply a small amount of grease to shaft. This will help prevent possibility of rotor sticking to motor shaft.
- Pump head cover bearing may require grease periodically. Apply a small amount of grease (Aeroshell aviation grease #5 or equivalent) when necessary.
- Although not necessary, 100% silicone lubrication may be used on roller assembly.
- Periodically clean injection/check valve assembly, especially when injecting fluids that calcify such as sodium hypochlorite. These lime deposits and other build ups can clog fitting, increase back pressure and interfere with check valve operation.
- Periodically clean suction strainer.

Additional information on tube replacement and pump maintenance can be found by visiting our videos at The Blue-White Academy. [2 Series Tube Replacement and Maintenance.](#)

Or scan the QR Code



17.1 Motor Brush Replacement

Brushes wear differently on each side of motor. It is recommended to replace both brushes at the same time.

Replacement Brush Kit: 72000-378

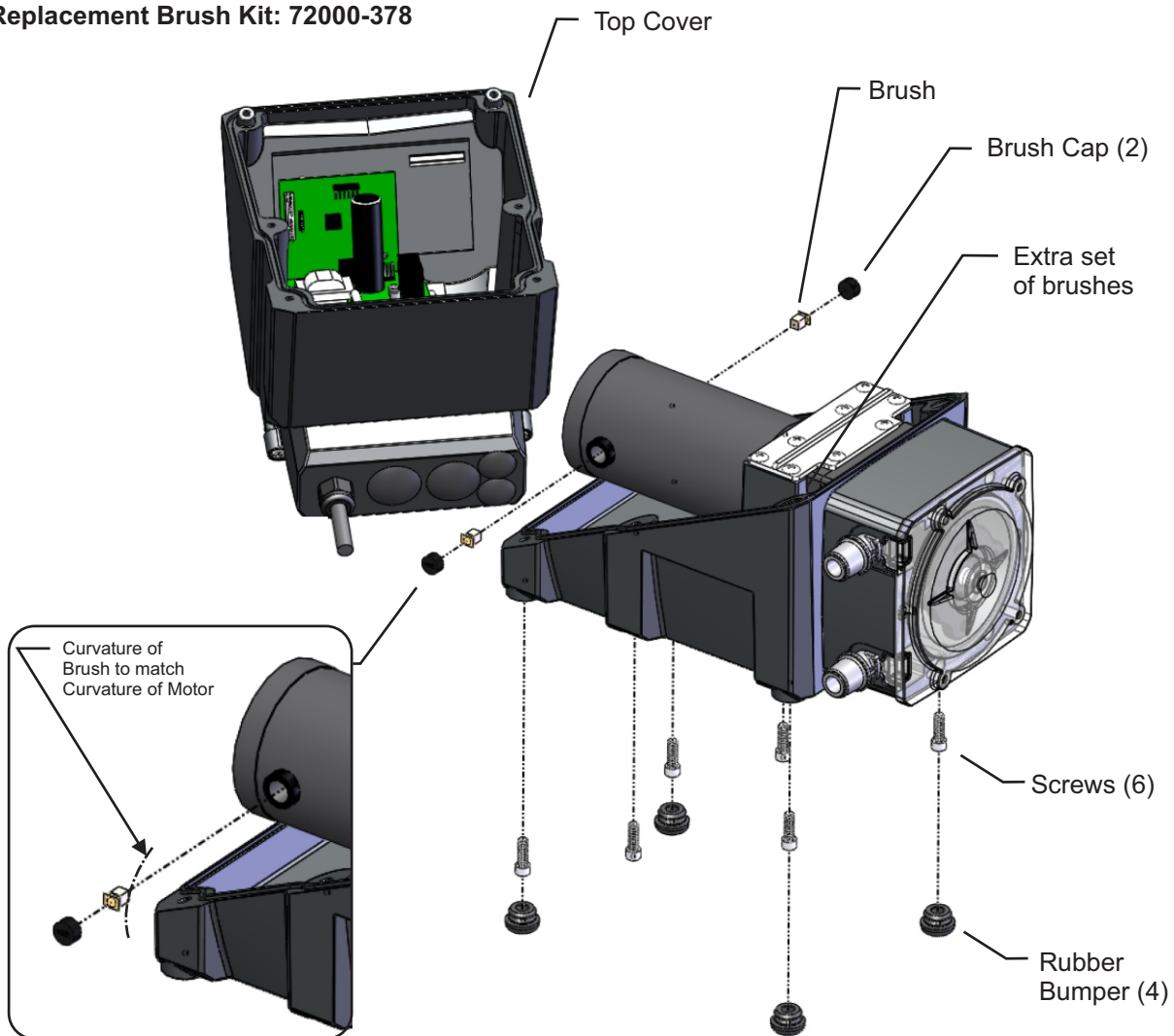

Step 1

Remove 4 black rubber bumpers from bottom frame.

Step 2

Remove 6 screws from underneath side of bottom frame.

Step 4

Lift off top cover from bottom frame carefully. Place top cover close to bottom frame.

Please Note: Wires connecting top and bottom may become unplugged if pulled too far apart.

Step 5

Unscrew and remove brush caps by turning counter-clockwise.

Step 6

Remove used brushes and discard properly.

Step 7

Insert new brushes. Be sure to install brushes to that curvature of brush is concentric to curvature of motor. Please note: One extra set of brushes are provided inside frame.

18.0 Pump Head Replacement Parts List

A2/M2 Replacement Parts

Pump Head Components		Part No.	QTY Req'd
1	Spacer, Rear	90011-217	1
2	Complete Roller Assembly		1
	ND	A2-SND-R	
	NEE / NGG	A2-SNGG-R	
	TH	A2-STH-R	
	GE / GG / G2G / GH	A2-SGE-R	
3	Tubing (Reference Tubing Matrix)		1
4	Pump Head Cover (includes front spacer)	A2-SXX-C	1
5	Thumb Screws	90011-183	4
6	Tube Nut, Compression 3/8" Tubing*	C-330-6	2
7	Spacer, Front	90011-217	1

*Tube nuts for 'S' type tubing only

Quick Disconnect Fittings*		Part No.	QTY Req'd
8	Quick Disconnect		1
	.50" Barb FKM	KIT-QBV	
	.50" Barb EP	KIT-QBE	
	.50" Barb Aflas	KIT-QBA	
	.50" M/NPT FKM	KIT-QMV	
	.50" M/NPT EP	KIT-QME	
	.50" M/NPT Aflas	KIT-QMA	
	3/8" OD, 1/4" ID Tube Compression, FKM	KIT-QSV	
	3/8" OD, 1/4" ID Tube Compression, EP	KIT-QSE	
	3/8" OD, 1/4" ID Tube Compression, Aflas	KIT-QSA	

*Only available for Q tubes

Miscellaneous Parts*		Part No.	QTY Req'd
A	Stainless Steel Mounting Bracket	72000-379	1
B	Stainless Steel Mounting Bracket (Extended)	72000-380	1
C	Rubber Feet	90003-561	4
D	Tube Installation Tool	90002-278	1

*Sold Separately

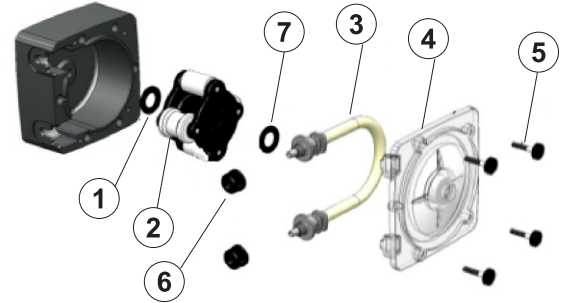

*Pump Head not for sale. For more information please contact a local sales representative.



A



B



C



D

18. Tube Replacement Parts List

FLEXFLO[®] Model Number

A2	Tubing					
Inlet/Outlet Connection Size, Connection Type, Connection Material						
S	3/8" OD x 1/4" ID Tube Compression Fitting, Natural PVDF (Kynar)					
M	1/2" Male NPT Fitting, Natural PVDF (Kynar)					
B	1/2" Hose Barb, Natural PVDF (Kynar), available for ND, NEE, NGG, and G2G only					
C	1/2" - 3/4" Tri-clamp connections, Natural PVDF (Kynar), available for ND, NEE, NGG, and G2G only					
Q	Quick Disconnect, Natural PVDF (Kynar), available for ND, NEE, NGG, and G2G only (valves sold separately)					
MB	1/2" Male BSPT Fitting, Natural PVDF (Kynar)					
Pump Tube Material, Pump Tube Size						
GE	Flex-A-Thane [®] .125 ID	ND	Flex-A-Prene [®] .075 ID			
GG	Flex-A-Thane [®] .187 ID	NEE	Flex-A-Prene [®] .093 ID			
G2G	Flex-A-Thane [®] .187 ID (dual tube)	NGG	Flex-A-Prene [®] .187 ID			
GH	Flex-A-Thane [®] .312 ID	TH	Flex-A-Chem [®] .250 ID			
A2	-	S	GE	-	T	Tube Sample Model Number

19.0 Output Versus Fluid Viscosity

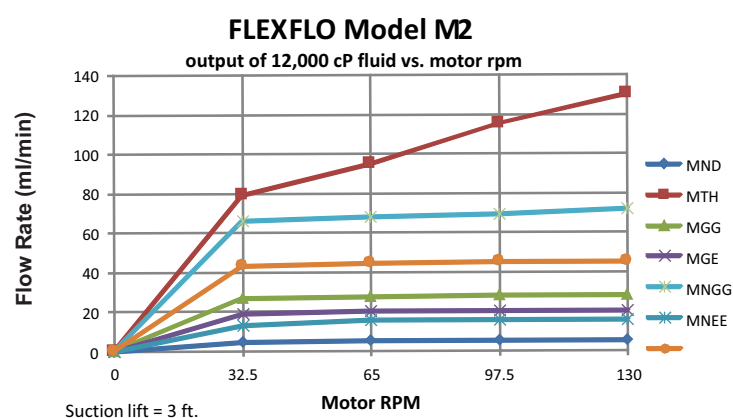
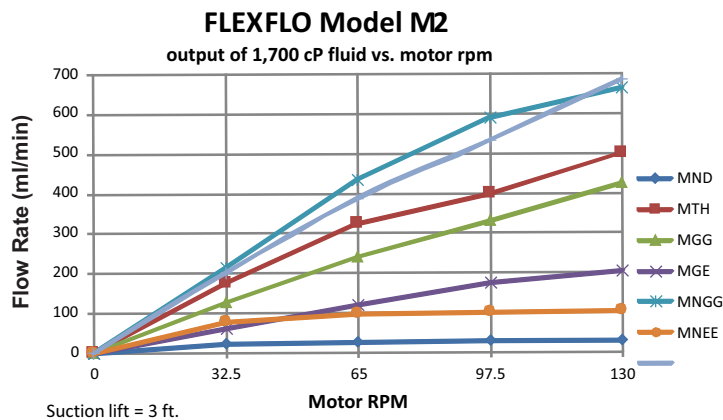
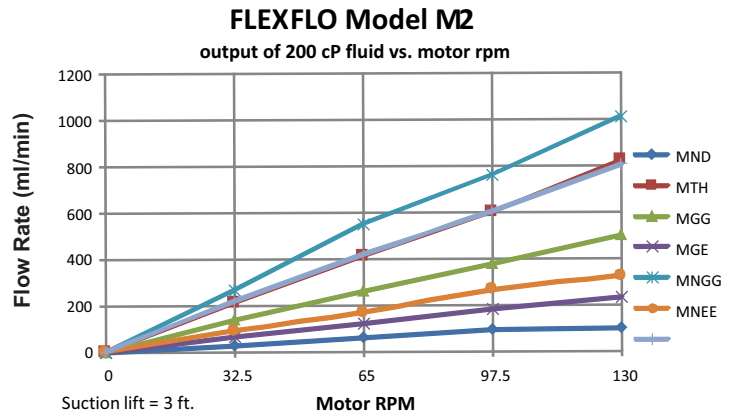
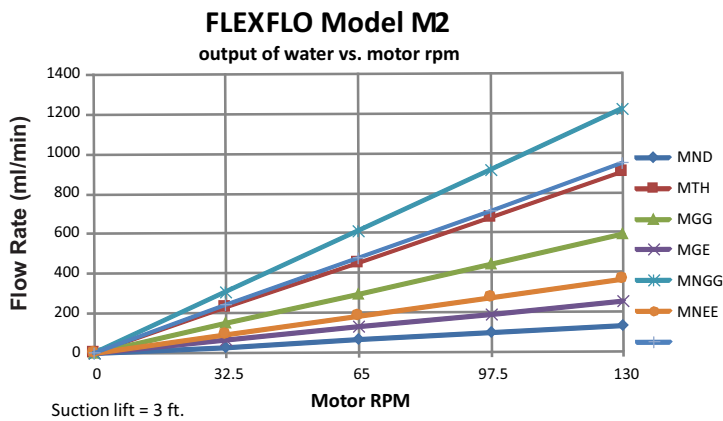

20.0 Volumetric Test - Calibration

The Max Flowrate value is equal to the pump's measured fluid output in milliliters per minute, at the 100% motor speed adjustment setting.

Each FLEXFLO pump is calibrated at the factory and shipped with a calibrated pump tube assembly installed. The Max flow rate value can be adjusted at any time. To achieve high accuracy, a field calibration under the actual operating conditions should be performed and the Max Flowrate value changed to reflect the calibrated amount. Multiply the **Max Flowrate** value by the percentage of error at your calibrated flow rate to obtain the new **Max Flowrate** value.

Every pump tube assembly model number has a published maximum flow rate value which is based on laboratory tests pumping water at room temperature at 36" suction lift against 0 psi back pressure. Your actual output may vary due to fluid viscosity, fluid temperature, suction lift height, piping system layout, manufacturing tolerances and to a lesser degree, variations in system pressure and tubing wear.

To achieve high accuracy, the pump's output should be measured (calibrated), and the MAX Flowrate value (in milliliters per minute) updated, whenever any of the following conditions exist:

- At the initial pump start up.
- When a new tube assembly is installed. *Run the pump with or without fluid for approximately 30 minutes prior to calibration.*
- When the piping system configuration is changed.
- When the suction lift height is changed.
- Periodically during the life of the tube. *Output variances are most noticeable prior to tube failure.*

To calculate the Max Flowrate:

To determine the amount of error at your output setting, divide the actual output amount by the indicated output. Then multiply the resulting percentage of error by the **Max Flowrate** value currently showing in the pump.

Example: If the pump display indicates the output is 170 ml/min but the actual measured output is 160 ml/min, calculate the percentage of error by: $160/170 = 0.941$. Multiply the **Max Flowrate** value by 0.941 and enter this new value.

21.0 WARRANTY

21.1 LIMITED WARRANTY

Your new FLEXFLO pump is a quality product and is warranted for 60 months from date of purchase (proof of purchase is required). The pump will be repaired or replaced at our discretion. Failure must have occurred due to defect in material or workmanship and not as a result of operation of the product other than in normal operation as defined in the pump manual. Warranty status is determined by the pump's serial label and the sales invoice or receipt. The serial label must be on the pump and legible. The warranty status of the pump will be verified by Blue-White or a factory authorized service center.

Pump Head and roller assembly is warranted against damage from chemical attack when proper TFD (Tube Failure Detection) system instructions and maintenance procedures are followed.

21.2 WHAT IS NOT COVERED

- Pump Tube Assemblies and rubber components – They are perishable and require periodic replacement.
- Pump removal, or re-installation, and any related labor charge.
- Freight to the factory, or service center.
- Pumps that have been tampered with, or in pieces.
- Damage to the pump that results from misuse, carelessness such as chemical spills on the enclosure, abuse, lack of maintenance, or alteration which is out of our control.
- Pumps damaged by faulty wiring, power surges or acts of nature.

21.3 PROCEDURE FOR IN WARRANTY REPAIR

Contact the factory to obtain a RMA (Return Material Authorization) number. Carefully pack the pump to be repaired. It is recommended to include foot strainer and injection/check valve fitting since these devices may be clogged and part of the problem. Please enclose a brief description of the problem as well as the original invoice or sales receipt, or copy showing the date of purchase. Prepay all shipping costs. COD shipments will not be accepted. Warranty service must be performed by the factory or an authorized service center. Damage caused by improper packaging is the responsibility of the sender. When In-Warranty repair or replacement is completed, the factory pays for return shipping to the dealer or customer.

21.4 PRODUCT USE WARNING

Blue-White products are manufactured to meet the highest quality standards in the industry. Each product instruction manual includes a description of the associated product warranty and provides the user with important safety information. Purchasers, installers, and operators of Blue-White products should take the time to inform themselves about the safe operation of these products. In addition, Customers are expected to do their own due diligence regarding which products and materials are best suited for their intended applications. Blue-White is pleased to assist in this effort but does not guarantee the suitability of any particular product for any specific application as Blue-White does not have the same degree of familiarity with the application that the customer/end user has. While Blue-White will honor all of its product warranties according to their terms and conditions, Blue-White shall only be obligated to repair or replace its defective parts or products in accordance with the associated product warranties. **BLUE-WHITE SHALL NOT BE LIABLE EITHER IN TORT OR IN CONTRACT FOR ANY LOSS OR DAMAGE WHETHER DIRECT, INDIRECT, INCIDENTAL, OR CONSEQUENTIAL, ARISING OUT OF OR RELATED TO THE FAILURE OF ANY OF ITS PARTS OR PRODUCTS OR OF THEIR UNSUITABILITY FOR A GIVEN PURPOSE OR APPLICATION.**

21.5 CHEMICAL RESISTANCE WARNING

Blue-White offers a wide variety of wetted parts. Purchasers, installers, and operators of Blue-White products must be well informed and aware of the precautions to be taken when injecting or measuring various chemicals, especially those considered to be irritants, contaminants or hazardous. Customers are expected to do their own due diligence regarding which products and materials are best suited for their applications, particularly as it may relate to the potential effects of certain chemicals on Blue-White products and the potential for adverse chemical interactions. Blue-White tests its products with water only. The chemical resistance information included in this instruction manual was supplied to Blue-White by reputable sources, but Blue-White is not able to vouch for the accuracy or completeness thereof. While Blue-White will honor all of its product warranties according to their terms and conditions, Blue-White shall only be obligated to repair or replace its defective parts or products in accordance with the associated product warranties. **BLUE-WHITE SHALL NOT BE LIABLE EITHER IN TORT OR IN CONTRACT FOR ANY LOSS OR DAMAGE, WHETHER DIRECT, INDIRECT, INCIDENTAL, OR CONSEQUENTIAL, ARISING OUT OF OR RELATED TO THE USE OF CHEMICALS IN CONNECTION WITH ANY BLUE-WHITE PRODUCTS.**

Model Number Matrix

M2

FLEXFLO® Model Number

M2 FLEXFLO® Peristaltic metering pump model number	
Power Cord (operating voltage user selectable 115V/240 Vac 50/60Hz)	
4 115V / 60Hz, power cord NEMA 5/15 plug (US)	8 240V / 50HZ, power cord AS 3112 plug (AU/New Zealand)
5 230V / 60Hz, power cord NEMA 6/15 plug (US)	9 230V / 50HZ, power cord BS 1363/A plug (United Kingdom)
6 220V / 50HZ, power cord CEE 7/VII plug (EU)	X No Power Cord
Inlet/Outlet Connection Size, Connection Type, Connection Material	
S 3/8" OD x 1/4" ID Tube Compression Fitting, Natural PVDF (Kynar)	C 1/2" - 3/4" Tri-clamp connections, Natural PVDF (Kynar), available for ND, NEE, NGG, and G2G only
M 1/2" Male NPT Fitting, Natural PVDF (Kynar)	Q Quick Disconnect, Natural PVDF (Kynar), available for NDD, NEE, NGG, and G2G only (valves sold separately)
B 1/2" Hose Barb, Natural PVDF (Kynar), available for ND, NEE, NGG, and G2G only	MB 1/2" Male BSPT Fitting, Natural PVDF (Kynar)
Pump Tube Material, Pump Tube Size, Output Range	
ND Flex-A-Prene® .075 ID 0.01-1.7 GPH .03-6.5 LPH .54-108 mL/M 125 PSI	
NEE Flex-A-Prene® .093 ID 0.022-4.44 GPH .084-16.8 LPH 1.4-280 mL/M 110 PSI	
NGG Flex-A-Prene® .187 ID 0.086-17.2 GPH .325-65.1 LPH 5.4-1085 mL/M 110 PSI	
GE Flex-A-Thane® .125 ID 0.02-4.0 GPH .08-15.2 LPH 1-253 mL/M 65 PSI	
GG Flex-A-Thane® .187 ID 0.05-9.3 GPH .17-35.2 LPH 3-587 mL/M 65 PSI	
G2G Flex-A-Thane® .187 ID 0.07-14.98 GPH .03-56.7 LPH 4.7-945 mL/M 65 PSI	
GH Flex-A-Thane® .312 ID 0.106-21.23 GPH .04-80.4 LPH 6.7-1340 mL/M 65 PSI	
TH Flex-A-Chem® .250 ID 0.07-14.3 GPH .27-54 LPH 4.5-900 mL/M 50 PSI	
Pumphead Orientation	
(Blank) Standard - Left facing	
R Right facing pumphead	
D Down facing pumphead	
M2 2 4 S ND R Sample Model Number	

Accessories



1/4" x 3/8" "S" Fitting
1/2" Hose Barb "B" Fitting
1/2" MNPT "M" Fitting

*KIT-QSV FKM O-rings	*KIT-QBV FKM	*KIT-QMV FKM
*KIT-QSE EP O-rings	*KIT-QBE EP	*KIT-QME EP
*KIT-QSA Aflas O-rings	*KIT-QBA Aflas	*KIT-QMA Aflas

Quick Disconnects

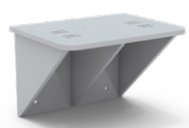

KIT-PSM
Wall Mount Bracket, HDPE



A-014NK-6A
Injector, PVDF, 1/4" "S" Conn.

Visit Accessory Pages for More Options



Users of electrical and electronic equipment (EEE) with the WEEE marking per Annex IV of the WEEE Directive must not dispose of end of life EEE as unsorted municipal waste, but use the collection framework available to them for the return, recycle, recovery of WEEE and minimize any potential effects of EEE on the environment and human health due to the presence of hazardous substances. The WEEE marking applies only to countries within the European Union (EU) and Norway. Appliances are labeled in accordance with European Directive 2002/96/EC.

Contact your local waste recovery agency for a *Designated Collection Facility* in your area.

Blue-White[®]

5300 Business Drive
Huntington Beach, CA 92649
USA

TEL: 714-893-8529
FAX: 714-894-9492

www.blue-white.com
sales@blue-white.com
customerservice@blue-white.com