

FLEXFLO[®]

Peristaltic Metering Pump



Series M4

1.0	Introduction	4	10.0	Industrial Protocols	37
1.1	What's in the box	5	10.1	Control and Status Mapping for Profibus and EtherNet/IP	37
2.0	Engineering Specifications	6	10.2	Control and Status Mapping for Modbus TCP	40
2.1	Output vs fluid viscosity	7	10.3	EtherNet/IP	43
3.0	Materials of Construction	8	10.4	Modbus TCP	44
3.1	Wetted Components	8	10.5	Profibus DP	45
3.2	Non-Wetted Components	8	11.0	Tubing	46
4.0	Features	9	11.1	Tube Information	46
4.1	Agency Listings	9	11.2	Tube Calibration	47
5.0	Installation	10	12.0	Settings	48
5.1	Mounting Location	10	12.1	Pump Name	48
5.2	Mounting Dimensions	11	12.2	Unit of Volume	49
5.3	Input Power Connections	12	12.3	Unit of Time	50
5.4	Wiring Terminals and I/O Schematics	13	12.4	Chemical Name	51
6.0	Layout	14	12.5	Max Motor RPM Cut-off	52
6.1	Home Screen Layout / Quick Tab Setting	14	12.6	Language	53
6.2	App Screen Layout	14	12.7	Pump Rotation Direction	54
6.3	M12 Connectors	15	12.8	Resume Operation upon Start-Up	55
6.4	IO Connectors	15	12.9	Factory Reset	56
6.5	M12 Connectors Description	16	12.10	System Time	57
7.0	Startup	18	12.11	Display Flow Rate, RPM, Speed, Input	58
7.1	Powering On/Off the pump	18	13.0	System	59
7.2	Welcome Screen	19	13.1	System Information	59
8.0	Input Setup	20	13.2	Firmware Update	60
8.1	Manual Input	20	14.0	Pump Maintenance	61
8.2	4-20 mA Input	21	14.1	Routine Inspection and Maintenance	55
8.3	Frequency Input	22	14.2	How to Clean and Lubricate the Pump	62
8.4	Pulse Input	23	14.3	Remove Pump Head /Tubing Replacement	63
8.5	Remote Start/Stop and Secondary Input	24	14.4	Pump Head and Roller Exploded Views	63
8.6	Flow Verification (FVS) (Quick Setting Opt)	25	14.5	TFD (Tube Failure Detection)	64
8.7	Prime the Pump	26	14.6	Predictive Tube Failure	65
8.8	Auto Prime	27	15.0	Replacement Parts	66
8.9	Manual Cycle Adjust	28	15.1	Replacement Parts	69
8.10	Dispensing	29	15.2	Tube Selection Matrix	67
8.11	Time of Day	30	16.0	Accessories	68
8.12	Revolution Alarm	31	17.0	Warranty	71
8.13	Passcode	32	APPENDIX A: ACRONYMS	72	
8.14	Local Only Mode (Via Quick Tab Setting)	33	APPENDIX B: MODEL NUMBER MATRIX	73	
9.0	Output Setup	34			
9.1	4-20mA Output	34			
9.2	Frequency Output	35			
9.3	Relay & Contact Output	36			

READ THE ENTIRE OPERATING MANUAL PRIOR TO INSTALLATION AND USE.



+1 (714) 893 - 8529



sales@blue-white.com



customerservice@blue-white.com



5300 Business Drive
Huntington Beach, CA 92649

Congratulations on purchasing the M4 FLEXFLO® variable speed Peristaltic Metering Pump.

Your FLEXFLO® M4 pump is pre-configured for the tubing that shipped with your metering pump. The tubing assembly has an Identification number printed for easy re-order.

Please Note: Your new pump has been pressure tested at the factory with clean water before shipping. You may notice trace amounts of clean water in the pre-installed tube assembly. This is part of our stringent quality assurance program at Blue-White Industries.

For more information please visit us at: www.blue-white.com

For videos and tutorials please visit as at:
<https://www.blue-white.com/resources/videos>

1.1 What's In The Box

The following items are included with every M4 peristaltic metering pump:

M4 Peristaltic Pump
With 6ft (1.8m) power cord



QR Code link to Support Hub (Instruction Manual, Datasheet, Videos, Parts, Accessories)

www.blue-white.com/support-hub-m4/



Standard Mounting Brackets



Extended Mounting Brackets



Spare Tubing



Maximum Working Pressure (excluding pump tubes)	125 psig (8.6 bar) NOTE: See individual pump tube assembly maximum pressure ratings.
Maximum Fluid Temperature (excluding pump tubes)	185 °F (85 °C) NOTE: See individual pump tube assembly max. temperature ratings.
Maximum Viscosity	12,000 Centipoise
Maximum Suction Lift	30 ft. Water, 0 psig (9.14 m, 0 bar)
Ambient Operating Temperature	14 °F to 115 °F (-10 °C to 46 °C)
Ambient Storage Temperature	-40 °F to 158 °F (-40 °C to 70 °C)
Operating Voltage	115VAC/60Hz, 1ph (3.1 Amp Maximum)
	230VAC/60Hz, 1ph (1.6 Amp Maximum)
	220VAC/50Hz, 1ph (1.6 Amp Maximum)
	240VAC/50Hz, 1ph (1.5 Amp Maximum)
	230VAC/50Hz, 1ph (1.5 Amp Maximum)
Power Cord Options	115V60Hz = NEMA 5/15 (USA)
	230V60Hz = NEMA 6/15 (USA)
	220V50Hz = CEE 7/VII (EU)
	240V50Hz = AS 3112 (Australia/New Zealand)
	230V50Hz = BS 1363/A (UK)
Motor	Brushless DC, 1/4 hp
Motor Speed Adjustment Range	10,000:1 (0.01% - 100% motor speed) Max RPM = 125
Motor Speed Adjustment Resolution	0.1% increments > 1% motor speed and < 100%
	0.01% increments < 1% motor speed
Motor Accuracy	+/- 0.5% of indicated RPM
Pump Accuracy	+/- 2% when calibrated for a specific tube at actual operating conditions
Display	5" touchscreen color LCD, UV resistant.
Display Languages	English, Spanish, French, German, and Portuguese selectable
Maximum Overall Dimensions	12-1/8"W x 15-1/4"H x 16-1/2"D (30.8W x 38.8H x 41.9D cm)
Product Weight	45.5 lb. (20.64 Kg)
Security	Programmable 6-digit password
Approximate Shipping Weight	50 lb. (22.68 Kg)
Enclosure	NEMA 4X (IP66), Polyester powder coated aluminum & Noryl
RoHS Compliant	Yes
Standards	cETLus, CE, NSF61

2.1 OUTPUT VERSUS FLUID VISCOSITY

Fluid viscosity and motor RPM both have an effect on fluid output. For your reference the charts below display the various tubes we offer and their output at different viscosities and different motor RPM. All testing was conducted with a three foot suction lift.

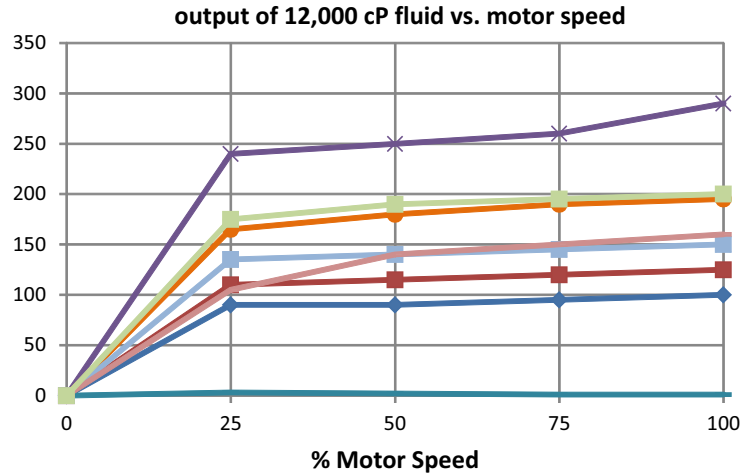
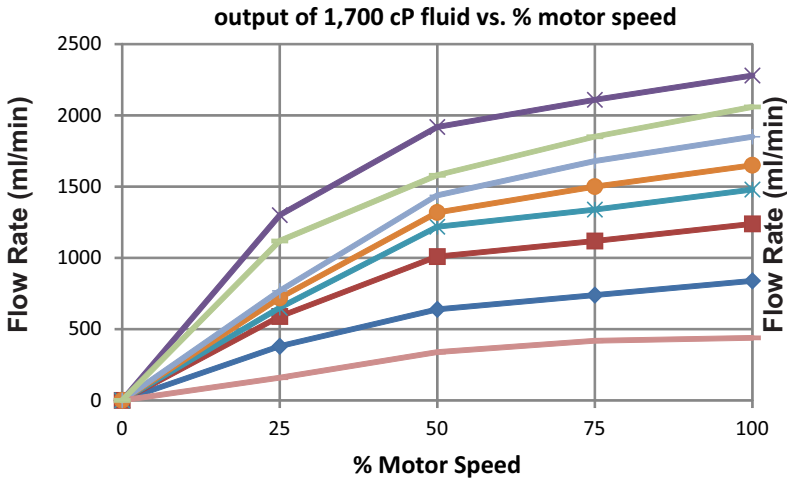
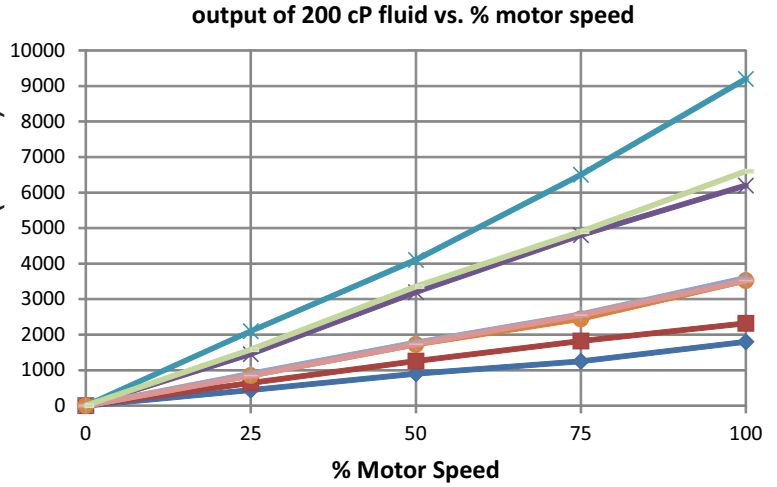
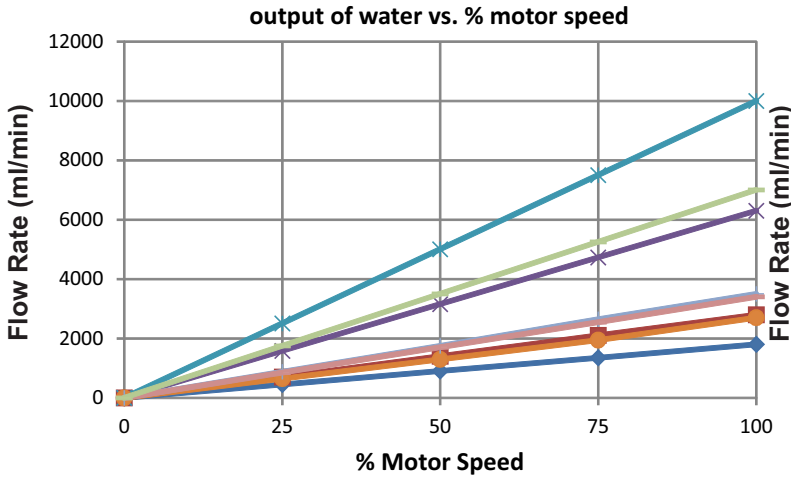

Tube Material

- BNH
- BNJ
- BNL
- BNP
- MTK
- MGK

+

3.1 Non-Wetted Components

Enclosure: 413 Aluminum (Polyester powder coated) & Noryl

Pump Head: Valox® (PBT) thermoplastic

Pump Head Cover: Polycarbonate

Permanently lubricated sealed motor shaft support ball bearing.

Cover Screws: Stainless steel, polypropylene cap

Roller Assembly:

Rotor: Valox® (PBT)

Rollers: Nylon

Roller Bearings: SS Ball bearings

Motor Shaft: Chrome plated steel

TFD System Sensor: Hastelloy C-276

Power Cord: 3 conductor, SJTW-A water-resistant

Tube Installation Tool: GF nylon

Mounting Brackets and Hardware: 316 Stainless steel

3.2 Wetted Components

Pump Tube Assembly:

Tubing: Flex-A-Prene®, Flex-A-Chem® or Flex-A-Thane®

Adapter Fittings: PVDF

Flex-A-Prene®, Flex-A-Chem®, and Flex-A-Thane® tubing comply with FDA 21 CFR, 117.2600 criteria for food processing.

Ancillary Items Not Included (sold separately):

Injection Fitting, Foot Valve/Strainer, Suction Tubing/Pipe, Discharge Tubing/Pipe, Quick Disconnect Valves, or Communications Wire/Cable.

4.1 Agency Listings



This pump is ETL listed to conform to the following: UL Standard 778 as a motor operated water pump. CSA Standard C22.2 as process control equipment



This pump complies to the Machinery Directive 2006/42/EC, BS, EN 60204-1, Low Voltage Directive 2014/35/EU BS EN 61010-1, EMC Directive 2014/30/EU, BS EN 50081-1/BS EN 50082-1.



This pump is certified to NSF/ANSI Standard 61- Drinking Water System Components - Health Effects

Symbol	Description
	Warning (Risk of electric shock)
	Caution (Refer to the user's guide)
	Ground, Protective Conductor Terminal

ENCLOSURE RATING

- NEMA 4X** Constructed for either indoor or outdoor use to provide a degree of protection to personnel against incidental contact with enclosed equipment; to provide a degree of protection against falling dirt, rain, sleet, snow, windblown dust, splashing water, and hose-directed water; and that will be undamaged by external formation of ice on enclosure.
- IP66** No ingress of dust; complete protection against contact. Water projected in powerful jets against enclosure from any direction shall have no harmful effects.

CAUTION

The pump should be serviced by qualified persons only. If equipment is used in a manner not specified in this manual, the protection provided by the equipment may be impaired.

CAUTION

Risk of chemical overdose. Be certain pump does not overdose chemical during backwash and periods of no flow in circulation system.

CAUTION

Always wear protective clothing, face shield, safety glasses and gloves when working on or near your metering pump. Additional precautions should be taken depending on solution being pumped. Refer to MSDS precautions from your solution supplier.

CAUTION

All diagrams are strictly for guideline purposes only. Always consult an expert before installing metering pump on specialized systems. Metering pump should be serviced by qualified persons only.

CAUTION

Be sure that installation does not constitute a cross connection with drinking water supply. Check your local plumbing codes.

CAUTION

The pump should be supplied by an isolating transformer or RCD (operating current less or equal 30 mA).

CAUTION

When pumping chemicals that off-gas, do not leave chemicals in pump for extended periods of non-use. These chemicals can expand and damage tubes, pump, and piping. Flush thoroughly when not in use.

5.1 Mounting Location

1. Choose an area located near the chemical supply tank, chemical injection point, and electrical supply. Also, choose an area where the pump can be easily serviced.
2. Finding a secure surface and using the provided mounting hardware, mount the pump close to the injection point. Keep the inlet (suction) and outlet (discharge) tubing as short as possible. Longer discharge tubing increases back pressure at pump head.

NOTE: Mounting the pump lower than the chemical container will gravity-feed chemical into it. This “flooded suction” installation will reduce output error due to increased suction lift. A shut-off valve, pinch-clamp, or other means to halt gravity-feed to the pump must be installed during servicing.

NOTE: Install a back flow prevention check valve at the discharge side of the pump to prevent the system fluid from flowing back through pump during tube replacement or during tube rupture.

NOTE: It is recommended to have a pressure relief valve at the discharge side of the of pump to prevent premature wear and damage to the pump tube, in the event that the discharge line becomes blocked.

NOTE: The pump does not require back pressure. Keep the discharge pressure as low as possible to maximize the tube life.

5.2 Pump Dimensions

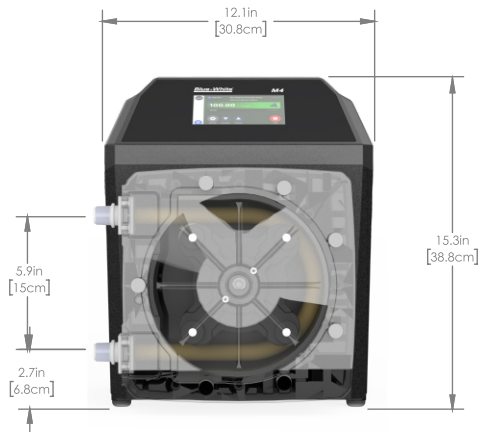

Front View

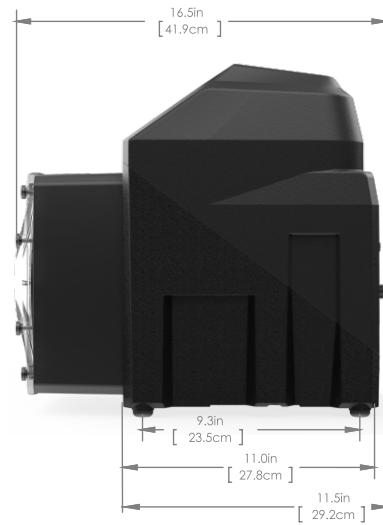

Side View

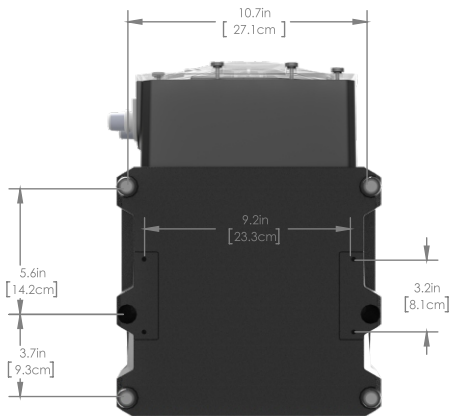

Bottom View

Mounting Hole Spacings
(for standard and extended type brackets)

Maximum bolt hole size
0.200" diameter (4 places)



Extended Brackets

Stainless Steel extended brackets allow the pump to be securely mounted to most any surface; floor, shelf, or skid. Brackets lift the pump up 4-1/2 inches (11.43 cm), for easy pump access in hard to reach areas.

- Raise metering pump 4-1/2 inches (11.43 cm) off ground or a surface.
- Made out of tough Stainless Steel.
- Provides a stable mounting surface.



5.3 Input Power Connections

WARNING 	Risk of electric shock – cord connected models are supplied with a grounding conductor and grounding-type attachment plug. To reduce risk of electric shock, be certain that it is connected only to a properly grounded, grounding-type receptacle.
WARNING 	Electrical connections and grounding (earthing) must conform to local wiring codes.
WARNING 	Risk of electric shock - Disconnect electricity before removing the wiring compartment cover.

- Be certain to connect pump to proper supply voltage. Using incorrect voltage will damage pump and may result in injury. Voltage requirement is printed on pump serial label.
- Input power range is 96VAC to 264VAC 50/60 Hz.
- Voltage Selection is automatically detected and adjusted by power supply. No mechanical switch necessary.
- Use power cord which is rated for your voltage.
- Power cord models are supplied with a ground wire conductor and a grounding type attachment plug (power cord). To reduce risk of electric shock, be certain that power cord is connected only to a properly grounded, grounding type receptacle.
- Be sure all M12 wiring cable glands are properly installed and sealed.
- Never strap control (input / output) cables and power cables together.
- **Power Interruption:** This pump has a user programmable auto-restart feature which will can either restore the pump to the operating state it was in when power was lost or require a user action to restart.

Note: When in doubt regarding your electrical installation, contact a licensed electrician.

	Input 1 Connector	Input 2 Connector	Output 1 Connector																									
INPUT 1	<table border="1" style="width: 100%; background-color: #444; color: white;"> <thead> <tr> <th>Pin</th> <th>Function</th> </tr> </thead> <tbody> <tr><td>P1</td><td>Remote Start/Stop</td></tr> <tr><td>P2</td><td>FVS (+)</td></tr> <tr><td>P3</td><td>FVS (-)</td></tr> <tr><td>P4</td><td>FVS (Signal)</td></tr> <tr><td>P5</td><td>Ground</td></tr> </tbody> </table>	Pin	Function	P1	Remote Start/Stop	P2	FVS (+)	P3	FVS (-)	P4	FVS (Signal)	P5	Ground		<table border="1" style="width: 100%; background-color: #444; color: white;"> <thead> <tr> <th>Pin</th> <th>Function</th> </tr> </thead> <tbody> <tr><td>P1</td><td>4-20mA Out (+)</td></tr> <tr><td>P2</td><td>4-20mA Out (-)</td></tr> <tr><td>P3</td><td>Contact N.O.</td></tr> <tr><td>P4</td><td>Contact N.C.</td></tr> <tr><td>P5</td><td>Ground</td></tr> </tbody> </table>	Pin	Function	P1	4-20mA Out (+)	P2	4-20mA Out (-)	P3	Contact N.O.	P4	Contact N.C.	P5	Ground	OUTPUT 1
Pin	Function																											
P1	Remote Start/Stop																											
P2	FVS (+)																											
P3	FVS (-)																											
P4	FVS (Signal)																											
P5	Ground																											
Pin	Function																											
P1	4-20mA Out (+)																											
P2	4-20mA Out (-)																											
P3	Contact N.O.																											
P4	Contact N.C.																											
P5	Ground																											
INPUT 2	<table border="1" style="width: 100%; background-color: #444; color: white;"> <thead> <tr> <th>Pin</th> <th>Function</th> </tr> </thead> <tbody> <tr><td>P1</td><td>Dry Contact</td></tr> <tr><td>P2</td><td>4-20mA In (+)</td></tr> <tr><td>P3</td><td>4-20mA In (-)</td></tr> <tr><td>P4</td><td>Pulse In (+)</td></tr> <tr><td>P5</td><td>Ground</td></tr> </tbody> </table>	Pin	Function	P1	Dry Contact	P2	4-20mA In (+)	P3	4-20mA In (-)	P4	Pulse In (+)	P5	Ground	Output 4 Connector	Output 3 Connector	Output 2 Connector												
Pin	Function																											
P1	Dry Contact																											
P2	4-20mA In (+)																											
P3	4-20mA In (-)																											
P4	Pulse In (+)																											
P5	Ground																											
OUTPUT 4	<table border="1" style="width: 100%; background-color: #444; color: white;"> <thead> <tr> <th>Pin</th> <th>Function</th> </tr> </thead> <tbody> <tr><td>P1</td><td>Not Used</td></tr> <tr><td>P2</td><td>Not Used</td></tr> <tr><td>P3</td><td>Relay N.O.</td></tr> <tr><td>P4</td><td>Relay N.C.</td></tr> <tr><td>P5</td><td>Ground</td></tr> </tbody> </table>	Pin	Function	P1	Not Used	P2	Not Used	P3	Relay N.O.	P4	Relay N.C.	P5	Ground		<table border="1" style="width: 100%; background-color: #444; color: white;"> <thead> <tr> <th>Pin</th> <th>Function</th> </tr> </thead> <tbody> <tr><td>P1</td><td>Pulse Out (+)</td></tr> <tr><td>P2</td><td>Pulse Out (-)</td></tr> <tr><td>P3</td><td>Contact N.O.</td></tr> <tr><td>P4</td><td>Contact N.C.</td></tr> <tr><td>P5</td><td>Ground</td></tr> </tbody> </table>	Pin	Function	P1	Pulse Out (+)	P2	Pulse Out (-)	P3	Contact N.O.	P4	Contact N.C.	P5	Ground	OUTPUT 2
Pin	Function																											
P1	Not Used																											
P2	Not Used																											
P3	Relay N.O.																											
P4	Relay N.C.																											
P5	Ground																											
Pin	Function																											
P1	Pulse Out (+)																											
P2	Pulse Out (-)																											
P3	Contact N.O.																											
P4	Contact N.C.																											
P5	Ground																											
OUTPUT 4	<table border="1" style="width: 100%; background-color: #444; color: white;"> <thead> <tr> <th>Pin</th> <th>Function</th> </tr> </thead> <tbody> <tr><td>P1</td><td>Not Used</td></tr> <tr><td>P2</td><td>Not Used</td></tr> <tr><td>P3</td><td>Contact N.O.</td></tr> <tr><td>P4</td><td>Contact N.C.</td></tr> <tr><td>P5</td><td>Ground</td></tr> </tbody> </table>	Pin	Function	P1	Not Used	P2	Not Used	P3	Contact N.O.	P4	Contact N.C.	P5	Ground		<table border="1" style="width: 100%; background-color: #444; color: white;"> <thead> <tr> <th>Pin</th> <th>Function</th> </tr> </thead> <tbody> <tr><td>P1</td><td>Not Used</td></tr> <tr><td>P2</td><td>Not Used</td></tr> <tr><td>P3</td><td>Contact N.O.</td></tr> <tr><td>P4</td><td>Contact N.C.</td></tr> <tr><td>P5</td><td>Ground</td></tr> </tbody> </table>	Pin	Function	P1	Not Used	P2	Not Used	P3	Contact N.O.	P4	Contact N.C.	P5	Ground	OUTPUT 3
Pin	Function																											
P1	Not Used																											
P2	Not Used																											
P3	Contact N.O.																											
P4	Contact N.C.																											
P5	Ground																											
Pin	Function																											
P1	Not Used																											
P2	Not Used																											
P3	Contact N.O.																											
P4	Contact N.C.																											
P5	Ground																											





5300 Business Drive
 Huntington Beach, CA 92649
 (714) 893-8529 blue-white.com

5.4 Wiring Terminals and I/O Schematics



Risk of electric shock - All wiring must be insulated and rated 300V minimum.

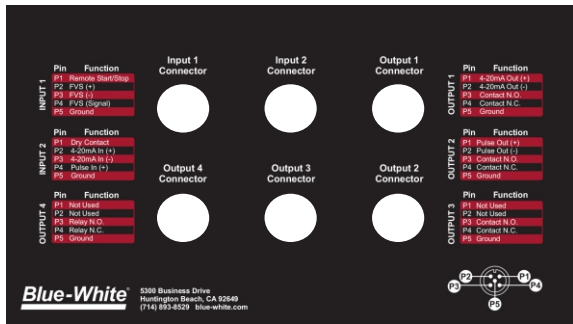

KIT-M12 WIRING INSTRUCTIONS		
DIAGRAM	PIN #	WIRE
	PIN 1	BROWN
	PIN 2	WHITE
	PIN 3	BLUE
	PIN 4	BLACK
	PIN 5	GRAY

Shielded cables should be used on all input signal wires.

FUNCTION	M12 Connector	PIN #	RATING	BLOCK DIAGRAM
INPUT: 4-20 mA	INPUT #2	2	(+) POSITIVE	
		3	(-) NEGATIVE	
INPUT: FREQUENCY, AC SINE WAVE, TTL, CMOS	INPUT #2	4	(+) POSITIVE	
		5	(-) NEGATIVE	
INPUT: FVS SYSTEM (FLOW VERIFICATION SENSOR) FV SENSOR ONLY	INPUT #1	2	(+) POSITIVE	
		3	(-) NEGATIVE	
		4	SIGNAL	
INPUT: FVS SYSTEM (FLOW VERIFICATION SENSOR) FS or FP MICRO-FLO FLOWMETER ONLY	INPUT #1	2	(+) POSITIVE	
		3	(-) NEGATIVE	
		4	SIGNAL	
INPUT: REMOTE START/STOP DRY CONTACT C PRIMARY	INPUT #1	1	(+) POSITIVE	
		5	(-) NEGATIVE	
INPUT: AUTO-PRIME/ DRY CONTACT C SECONDARY	INPUT #2	1	(+) POSITIVE	
		5	(-) NEGATIVE	
OUTPUT: 4-20 mA	OUTPUT #1	1	(+) POSITIVE	
		2	(-) NEGATIVE	
OUTPUT: FREQUENCY-OPEN COLLECTOR	OUTPUT #2	1	(+) POSITIVE	
		2	(-) NEGATIVE	
OUTPUT: CONTACT CLOSURE #1	OUTPUT #1	3	NORMALLY OPEN	
		4	NORMALLY CLOSED	
		5	COMMON (GROUND)	
OUTPUT: CONTACT CLOSURE #2	OUTPUT #2	3	NORMALLY OPEN	
		4	NORMALLY CLOSED	
		5	COMMON (GROUND)	
OUTPUT: CONTACT CLOSURE #3	OUTPUT #3	3	NORMALLY OPEN	
		4	NORMALLY CLOSED	
		5	COMMON (GROUND)	
OUTPUT: RELAY 6 AMP	OUTPUT #4	3	NORMALLY OPEN	
		4	NORMALLY CLOSED	
		5	COMMON (GROUND)	

WARNING:
DO NOT ALLOW INPUT #1 P1 AND P2 WIRES TO TOUCH ON M12 CABLE WIRING OR THE PUMP WILL MALFUNCTION.

Excitation voltage = 15V

6.1 HOME SCREEN LAYOUT

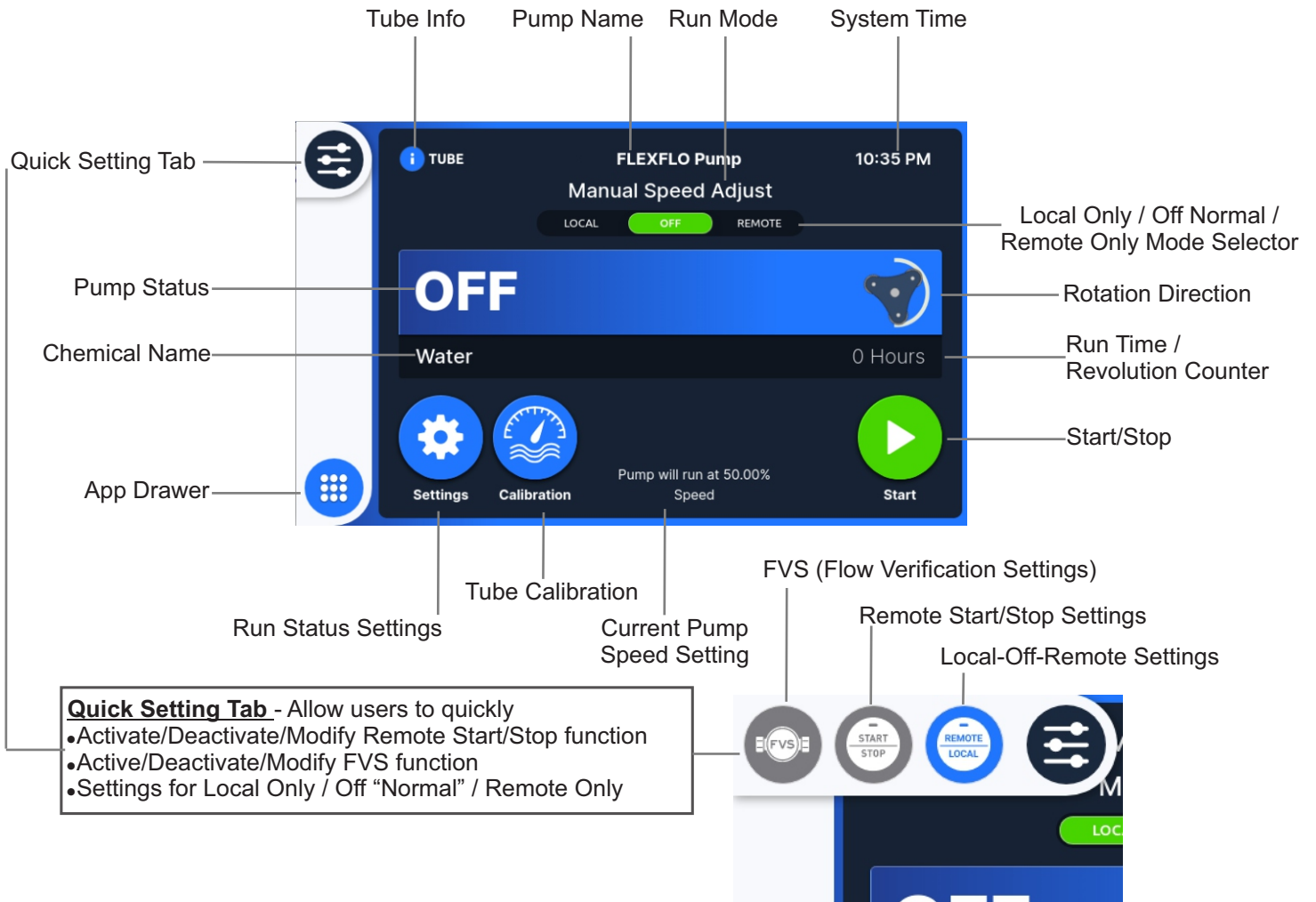

6.2 APP SCREEN LAYOUT

Note:

Scroll right to see more options.

Not all App Settings are available in Local Only or Remote Only Modes. Put pump in OFF mode to access all App Settings.

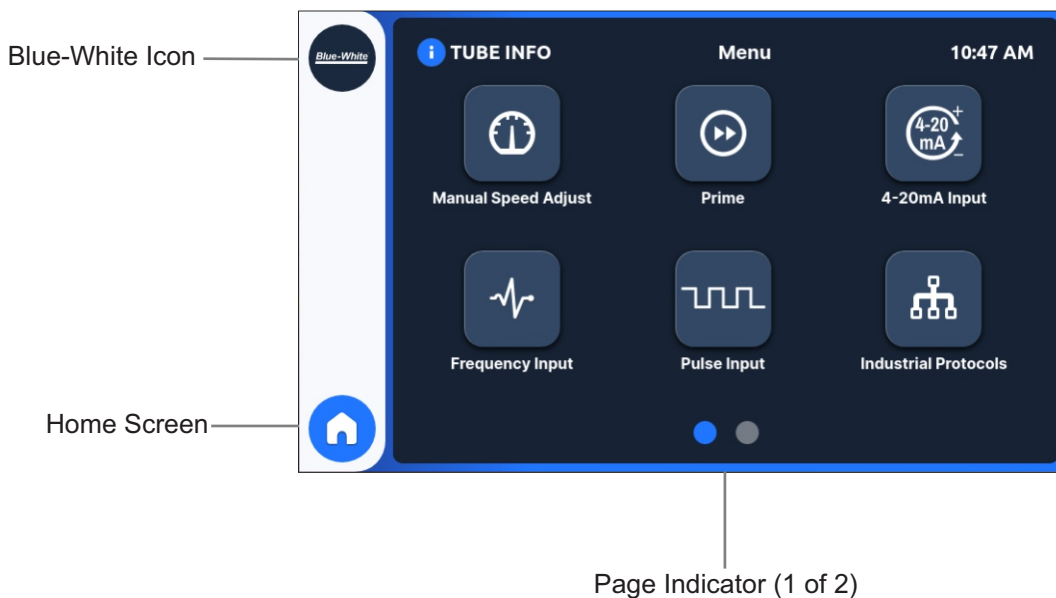

6.3 M12 Connector

Pump (Rear Upper Panel)

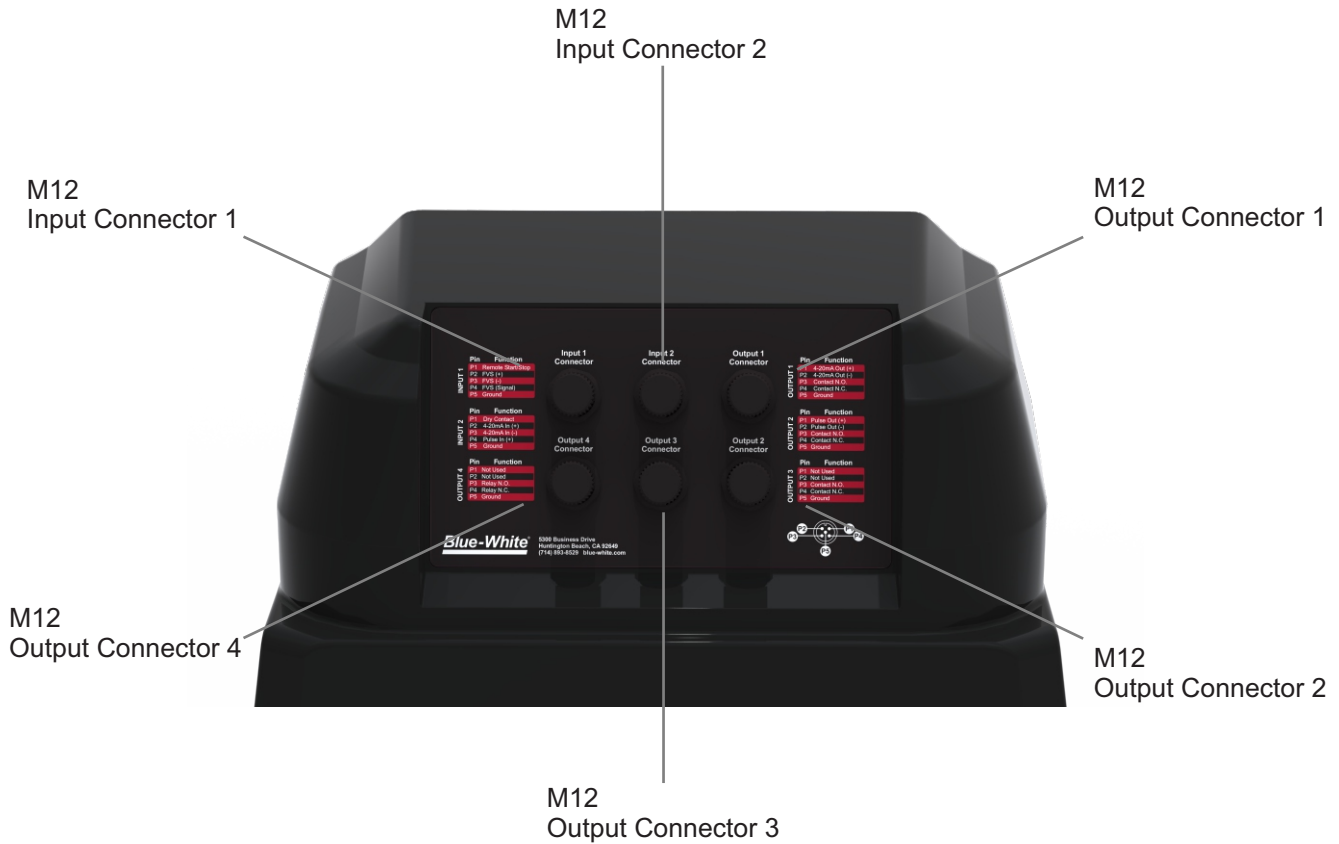

6.4 IO Connection

Pump (Rear Lower Panel)

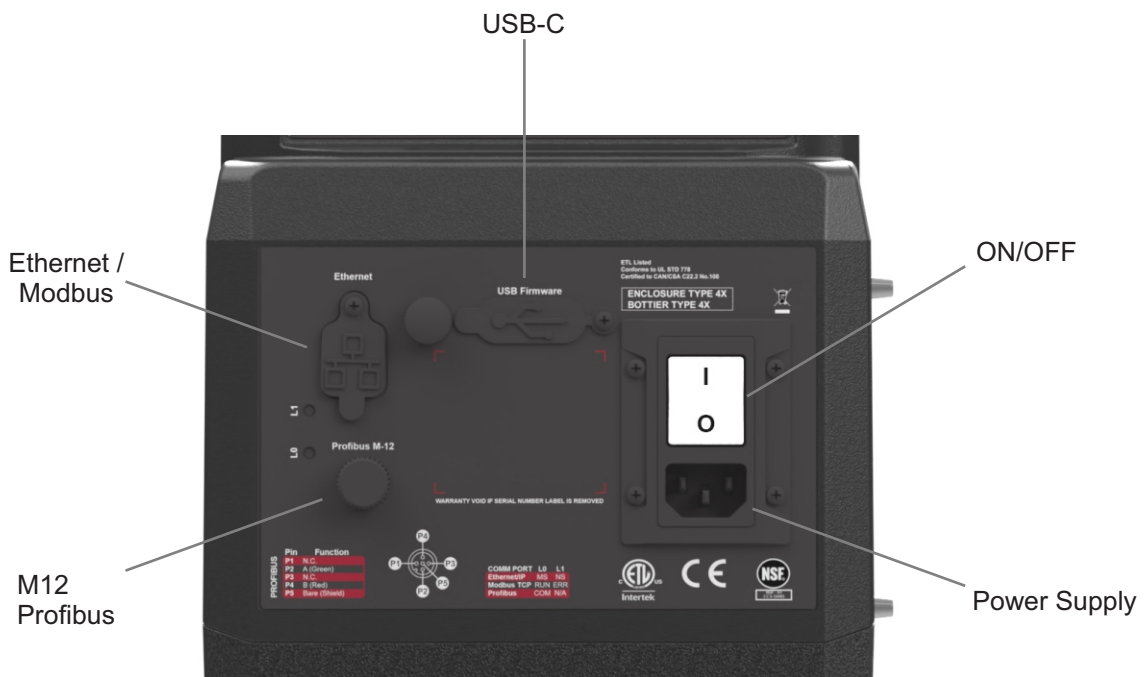

6.5 M12 Connector

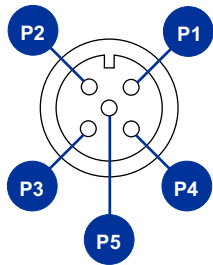

M12 Input/Output Connector

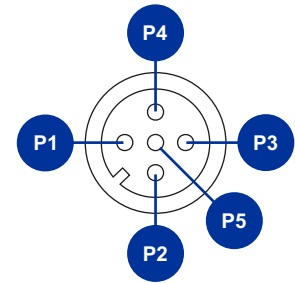

M12 Profibus Connector

M12 Input Connector 1

PIN	Function	Specifications	Reference
P1	Remote Start/Stop	No Voltage	
P2	FVS (+)	15 VDC @ 60 mA Supply	Power FVS Sensor
P3	FVS (-)	DC GND (0 VDC)	FVS Ground Input
P4	FVS (Signal)	Input Signal	FVS Input Signal
P5	Ground	DC Ground	0 VDC

M12 Input Connector 2

PIN	Function	Specifications	Reference
P1	Auto Prime/ Secondary Input	N.O. Dry Contact Closure	Open= Stop Gnd= Run
P2	4-20mA In (+)	120Ω Impedance Loop Ref. to Ground	Voltage = 15VDC to 24VDC
P3	4-20mA In (-)	DC GND (0 VDC)	
P4	Pulse In (+)	0-1000 Hz (AC. Square Wave) Ref. to Ground	
P5	Ground	DC GND (0 VDC)	

M12 Output Connector 1

PIN	Function	Specifications	Reference
P1	4-20mA Out (+)		750 Ohm max load
P2	4-20mA Out (-)	DC GND (0 VDC)	
P3	N.O.	Contact closure output #1 N.O. Contact 1 Amp @ 125 VAC	.8 Amp Max @ 30VDC 1 Amp @ 125 VAC
P4	N.C.	Contact closure output #1 N.C. Contact	.8 Amp Max @ 30VDC 1 Amp @ 125 VAC
P5	Ground	Contact closure output #1 COM Contact	

M12 Output Connector 2

PIN	Function	Specifications	Reference
P1	Pulse Out (+)	0-1000 Hz (AC. Square Wave) Ref. to Ground	
P2	Pulse Out (-)	DC GND (0 VDC)	
P3	N.O.	Contact closure output #2 N.O. Contact	.8 Amp Max @ 30VDC 1 Amp @ 125 VAC
P4	N.C.	Contact closure output #2 N.C. Contact	.8 Amp Max @ 30VDC 1 Amp @ 125 VAC
P5	Ground	Contact closure output #2 COM Contact	

M12 Output Connector 3

PIN	Function	Specifications	Reference
P1	Not Used		
P2	Not Used		
P3	N.O.	Contact closure output #3 N.O. Contact	.8 Amp Max @ 30VDC 1 Amp @ 125 VAC
P4	N.C.	Contact closure output #3 N.C. Contact	.8 Amp Max @ 30VDC 1 Amp @ 125 VAC
P5	Ground	Contact closure output #3 COM Contact	

M12 Output Connector 4

PIN	Function	Specifications	Reference
P1	Not Used		
P2	Not Used		
P3	N.O.	Relay Out, N.O. Contact	6 Amp Max @ 250VAC, 5 Amp MAX @ 30VDC
P4	N.C.	Relay Out, N.C. Contact	6 Amp Max @ 250VAC, 5 Amp MAX @ 30VDC
P5	Ground	Relay Out, COM Contact	

Warning! Never allow M12 cable wires to touch while the pump is active. Wiring shorts will cause the pump to malfunction and can void the warranty. Protect or tape unused wires as necessary.



M12 Profibus Connector

PIN	Function	Specifications	Reference
P1	VP		+5V supply for terminating resistors
P2	RxD/TxD-N		Data line minus (A-line)
P3	DGND		Data ground
P4	RxD/TxD-P		Data line plus (B-line)
P5	Shield		Ground connection

Note:

M12 cables not included with product.

Input/Output Connectors requires any A-Type M12 connector with 5 position female sockets

Profibus Connectors requires any B-Type M12 connector with 5 position female sockets

If the pump is the last bus device connected to the PROFIBUS cable it must be terminated using terminating resistor (PROFIBUS standard EN 50170).

7.1 Powering On The Pump

The M4 is equipped with a rocker switch to power ON/OFF the pump. Ensure that the power cord is securely plugged into the corresponding power source before powering on the pump.



"I" is pressed to turn on the pump

"O" is pressed to turn off the pump

7.2 Welcome Screen

The first time the pump is powered on, or after a factory reset, the pump will boot up to the Welcome Screen. Follow the onscreen instructions to configure your M4 pump. Refer to section 11 of this manual to change any of these options after you have finished the initial configuration.

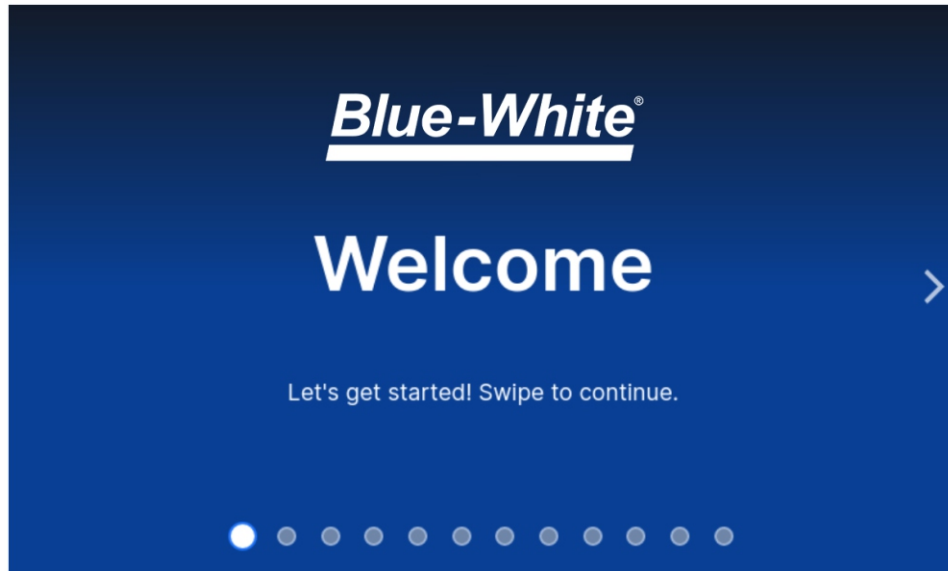

Welcome Screen Configuration

1

Local Language

2

Set Time

- Local Date
- Local Time Zone
- Local Time

3

Set Name

- Pump Name
- Chemical Name

4

Set Units

- Unit of Volume
- Unit of Time

5

Set Tube Type

6

Set User Password





8.1 Manual Speed Adjust

This input mode allows the user to set a specific speed and the pump will run at that speed until stopped. There are up and down arrows on the home screen to incrementally adjust the speed of the motor.

Default: Percent motor speed.

Also Available: Percent motor speed
RPM
Flow rate

To Enable Manual Speed Adjust (While in “LOCAL ONLY” or “OFF” mode):

- 1  Open the **App Drawer**
- 2  Select **Manual Speed Adjust**
- 3  Select **Start** to enable Manual Speed
- 4  Tap on the feed rate to cycle through to the option you want to manually adjust
 - Percent motor speed
 - RPM
 - Flow rate
- 5  Adjust manual speed by selecting **Increase** or **Decrease**

Option: Stop pump and select settings to input desired motor speed.



Confirm by pressing “Save”

8.2 4-20mA Input

This input mode allows the user to set a range of mA input signals to a given motor speed, flow rate or rpm. Used to remotely control the pump with an incoming 4-20mA signal.

Four points on the slope must be defined:

- 1) a low mA value
- 2) an output rate at the low mA value
- 3) a high mA value
- 4) an output rate at the high mA value

Default settings: 4mA = 0% motor speed
 20mA = 100% motor speed

To Enable 4-20mA Input (While in “REMOTE ONLY” or “OFF” Mode):

1 
Open the **App Drawer**

2 
Select **4-20mA Input**

3 
Select **Settings** to adjust
4-20mA input values

4
Confirm by selecting **Save**

5 
Select **Start** to enable 4-20mA
Input

Option: Stop the pump and select the graph icon to easily adjust sliders to desired settings

Confirm by pressing “Save” 

8.3 Frequency Input

This input mode is used to remotely control the pump with an incoming high speed frequency signal.

Four points on the slope must be defined:

- 1) a low Hz value
- 2) an output rate at the low Hz value
- 3) a high Hz value
- 4) an output rate at the high Hz value

Default settings: 0 (Hz) = 0% motor speed
 1000 (Hz) = 100% motor speed

To Enable Frequency Input (While in “REMOTE ONLY” or “OFF” Mode):

1 
Open the **App Drawer**

2 
Select **Frequency Input**

3 
Select **Settings** to adjust
Frequency Input

6
Confirm by pressing **Save**

5 
Select **Start** to enable
Frequency Input

Option: Stop pump and select graph icon to easily adjust sliders to desired settings



Confirm by pressing “Save”

8.4 Pulse Input

This input mode allows the user to trigger the pump to dispense a measured amount of chemical (Amount Per Trigger) over a specific period of time (Pump On Time), after a specific number of pulses (Pulses Count Trigger). Used to remotely control the pump with an incoming pulse signal.

Default settings: Pulse Count Trigger = 1

Pump On Time = 2.5 seconds

Amount Per Trigger = Fluid supplied per trigger

To Enable Pulse Input (While in “REMOTE ONLY” or “OFF” Mode):

1



Open the **App Drawer**

2



Select **Pulse Input**

3



Select **Settings** to adjust Pulse Input

- Input value for Pulse Count Trigger
- Input value for Amount Per Trigger
- Input value for Pump On Time

4

Confirm by pressing **Save**

5



Select **Start** to enable

6

Pump will be in **Standby Mode**

8.5 Remote Start/Stop



This input mode is used to remotely start and stop the pump using a close=stop or open=stop signal.

Primary Remote Switch - Used to Start/Stop the pump

Secondary Remote Switch - Used in conjunction with a pressure switch or level switch (M12 Input Connector 2) - Will stop pump if closed. **(Note: This option will be removed if using Auto-Prime feature.)**

Default settings: Disabled

To Enable Remote Start/Stop (While in “REMOTE ONLY” or “OFF” Mode):

- 1**  Open the **App Drawer**
- 2**  Select **Settings**
- 3**  Select **Remote Start/Stop**
- 4** Set **Remote Switch**

 - Disable
 - Normally Open (Closed to stop the pump)
 - Normally Closed (Open to stop the pump)
- 5** Set **Secondary Remote Switch**

 - Disable
 - Enable
- 6** Confirm by pressing **Save Pump** will be in Standby Mode.

Note: Remote Start/Stop can also be accessed via the Quick Setting Tab on the Home Screen

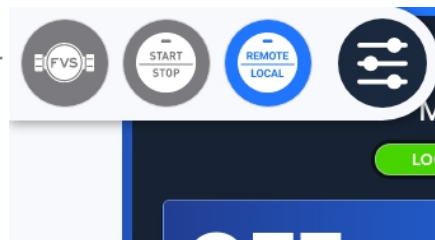

IMPORTANT: To begin operation, press the START button to place pump in STANDBY. The display background will turn yellow indicating the pump has been stopped remotely. When the pump is started by the remote contact, the display background will turn green.

IMPORTANT: If the Remote Start/Stop Input is enabled, the pump will display STANDBY if the pump has been stopped by the Remote Start/Stop. **Please use caution in this mode as the pump may Start at anytime. If you must perform maintenance to the pump, Press STOP button.**

8.6 Set FVS (Flow Verification System)

This input mode is used to monitor the pump fluid input. If the pump does not dispense fluid when pump head rotor is turning, the pump will go into an alarm mode and stop. FVS requires a sensor that is connected to the inlet of the pump to monitor the fluid input. Blue-White offers two flow verification sensors: [The MS6](#) & [The MICRO-FLO Flow Meter](#) that easily install into the inlet of the M4.

Default settings: Disabled

When enabled set trigger display (in seconds)

To Enable FVS:

1 
Open the **App Drawer**

2 
Select **Settings**

3 
Select **FVS**

4
Enable **FVS Input**

5
Set **Desired Trigger Delay**
(1-1000 seconds)

6
Confirm by pressing **Save**

Note: FVS Settings can also be accessed via the Quick Setting Tab on the Home Screen

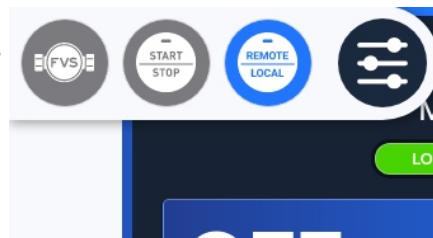

8.7 Prime

This mode allows the user to prime the pump at 100% motor speed for sixty seconds. After the prime is complete the pump will remain in this mode ready to be primed again.

To exit: select another input method.

To Prime The Pump (While in “LOCAL ONLY” or “OFF” mode):

1 
Open the **App Drawer**

2 
Select **Prime**

3 
Select **Start** to Prime the pump

4
Pump will run at 100% motor speed for sixty seconds

5
Pump will remain in **Prime Input**

8.8 Auto-Prime

This mode will allow the user to prime the pump remotely using the dry contact. Both prime duration and percent motor speed is configurable. (This feature uses the P1 contact on Input #2 connector. Note: Can not be used if using Secondary Contact Input)

Default settings: 60 Seconds at 100% Motor Speed

To Enable Auto-Prime:

1 
Open the **App Drawer**

2 
Select **Settings**

3 
Select **Auto-Prime**

4
Enable **Auto-Prime**

5
Input Values

- Prime duration (in seconds)
- Percent Motor Speed

6
Select **Save** to save the settings

IMPORTANT: This feature will be disabled when in “Local Only Mode”.

IMPORTANT: Please use caution when using this feature as the pump may Start or change speeds at anytime.

8.9 Manual Cycle Adjust

This input mode allows the user to run the pump at a set motor speed (Pump Speed) for a set amount of time (Duty Time) after which the pump will pause for a set amount of time (Cycle Time). This cycle will repeat until the user presses the STOP button.

Default settings: Pump Speed = 100% Motor Speed
 Duty Time = 1.5 Seconds
 Cycle Time = 4.0 Seconds

To Enable Manual Cycle Adjust (While in “LOCAL ONLY” or “OFF” mode):

1 
Open the **App Drawer**

2 
Select **Manual Cycle Adjustment**

3 
Select **Settings** to configure Manual Cycle Adjustment settings

4
Set **Pump Speed**
(0.04 - 100 percent)

5
Set **Duty Time**
(1 - 1,000,000 seconds)

6
Set **Cycle Time**
(1 - 1,000,000 seconds)



7
Confirm by pressing **Save**

8.10 Dispensing

This input mode allows the user to dispense a set amount of fluid (in milliliters) at a set rate (Motor % Speed).

Default settings: Amount Per Dispense = 1,000 mL
 Motor % Speed = 50%

To Enable Dispensing (While in “LOCAL ONLY” or “OFF” mode):

-  1
Open the **App Drawer**
-  2
Select **Dispensing**
-  3
Select **Settings** to configure Dispensing settings
- 4
Select Profile to Program (4 Profiles)
- 5
Set **Amount Per Dispense** (in milliliters)
Set **Motor % Speed** (0.04 -100)
- 6
Dispense Run Time will be displayed.
Confirm by pressing **Save**

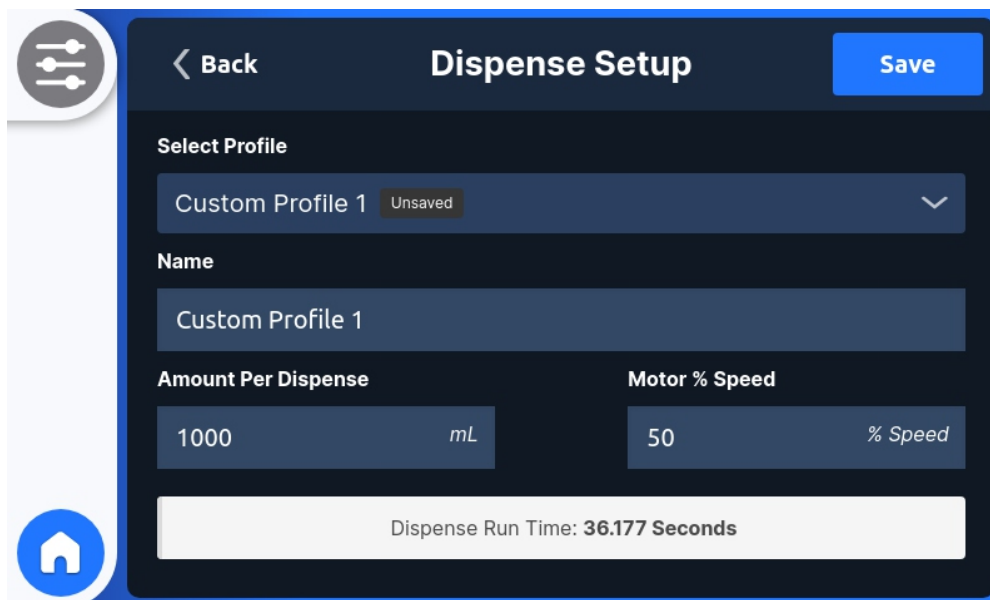

Note: If your Dispense run time is shorter than 1 second the pump will generate a “Run Time Too Short!” ERROR. Please reconfigure dispensing settings to be greater than 1 second

8.11 Time of Day

This mode allows the user to run the pump at a specific motor speed for a specific length of time beginning at a specific time of day.

Three values to be defined:

- 1) Percent Motor Speed
- 2) Run time (in minutes)
- 3) Time of Day that the pump will turn on

To Enable Time of Day:



Open the **App Drawer**



Select **Time of Day**



Select **Settings** to configure

4

Input Values

- Motor Speed (percentage)
- Run Time (in minutes)
- Time of Day

5

Select **Save** to save the settings



Verify the time on the pump is in synch with your local time zone

8.12 Revolution Alarm

This mode will allow the user to set an alert once a set number of revolutions has been reached. One of the primary factors effecting tube life is the number of revolutions the tube has operated. A revolution alarm set point can be inputted which will alert the user when the tube should be serviced. When the set point is reached, the pump will display “Revolution Count Exceeded” however **THE PUMP WILL NOT STOP**

Default settings: Amount will vary depending on tube that is installed

To Enable Revolution Alarm:

-  **1**
Open the **App Drawer**
-  **2**
Select **Settings**
-  **3**
Select **Revolution Alarm**
- 4**
Enable **Revolution Alarm**
- 5**
Input Values
•Amount of Revolutions
- 6**
Select **Save** to save the settings

8.13 Passcode

This setting is used to enable/disable the passcode, adjust the passcode time out and set or change the User Passcode.

Default settings: Pump will lockout after 30 seconds

To Input a Passcode:

1 
Open the **App Drawer**

2 
Open **Settings**

3
Open **Passcode**

4
Enable Passcode

5
Select **User Passcode** and
create new a six digit code.

6
Confirm by pressing **Save**



Lost password? Email customerservice@blue-white.com to have your password reset

8.14 Local Only Mode

This mode will allow the user to put the pump into a state where all remote input signals are disabled. The pump may only be operated and run manually (Manual Speed Adjust) at the pump.

Features disabled are : Remote Start/Stop, 4-20ma Input, Frequency Input, Pulse Input, Auto Prime, Communications (Ethernet IP, Modbus TCP, Profibus) inputs.

To Enable Local Only Mode:

- 1  Stop the Pump
- 2  Press "LOCAL" Key
- 3  Press "OK" to confirm
Local Mode is Enabled

To Disable Local Only Mode:

- 1  Stop the Pump
- 2  Press "OFF" or "REMOTE" Key
- 3  Local Mode is Disabled and pump will be returned to previous operation

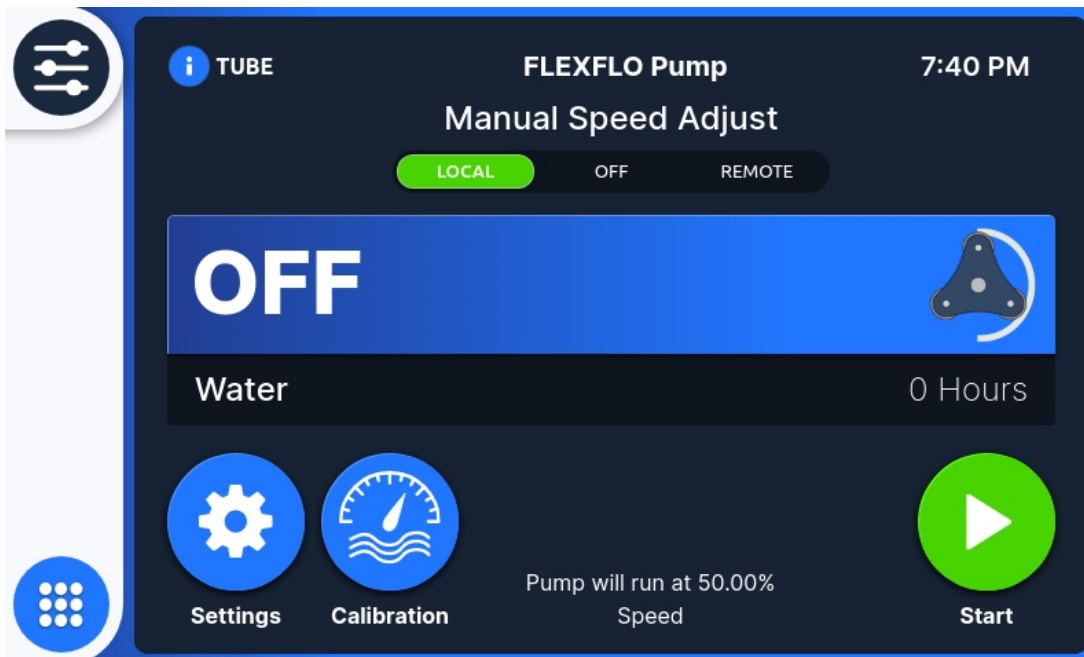

9.1 Set 4-20mA Output

This output sends a configurable 4-20mA. This feature can be used to control other pumps (in sync / proportionally), data logging systems, and other external devices for plant automation.

Four points on the slope must be defined:

- 1) a low mA value
- 2) an output rate at the low mA value
- 3) a high mA value
- 4) an output rate at the high mA value

Default settings: 4mA = 0 percent motor speed
 20mA = 100 percent motor speed

To Enable 4-20mA Output:

1 
Open the **App Drawer**

2 
Select **Outputs**

3 
Select **4-20mA Output**

4
Enable **4-20mA Output**

5
Set desired values for the four points that is required.

6
Confirm by pressing **Save**

Option: Stop the pump and select the graph icon to easily adjust sliders to desired settings

Confirm by pressing "Save"



9.2 Frequency Output

This output sends a configurable high speed frequency signal. This feature can be used to control other pumps (in sync / proportionally), data logging systems, and other external devices for plant automation.

Four points on the slope must be defined:

- 1) a low Hz value
- 2) an output rate at the low Hz value
- 3) a high Hz value
- 4) an output rate at the high Hz value

Default settings: 0 Frequency (Hz) = 0 percent motor speed
 1000 Frequency (Hz) = 100 percent motor speed

To Enable Frequency Output:

1 
Open the **App Drawer**

2 
Select **Outputs**

3 
Select **Frequency Output**

4
Enable **Frequency Output**

5
Set **Desired Values**

6
Confirm by pressing **Save**

Option: Stop the pump and select the graph icon to easily adjust sliders to desired settings

Confirm by pressing "Save"



9.3 Relay & Contacts

This feature is used to assign alarms to relay & contact closures

Four values to be defined:

- 1) Contact #1
- 2) Contact #2
- 3) Contact #3
- 4) Relay Output

To Enable Relay & Contacts:

1  Open the **App Drawer**

2  Select **Outputs**

3  Select **Relay & Contacts**

4
Set **Desired Values**
(refer to chart below)

- Contact #1
- Contact #2
- Contact #3
- Relay Output

5
Confirm by pressing **Save**

Selection:	Contact energizes when:
Pump Run/Stop	Motor turning (roller assembly is rotating)
Monitor Input	Incoming analog or digital signal is not received or out of range
Monitor Output	Outgoing analog or digital signal not transmitted or out of range
Monitor Run/Fail	Motor fails to respond to commands
Revolution Alarm	Programmed Revolution Counter reaches set point
4-20 In Active	4-20mA mode is running
Frequency In Active	Frequency mode is running
Manual Speed Active	Manual Speed mode is running
Pulse In Active	Pulse In mode is running
Prime Active	Prime mode is running
Pump Available	Pump is On
Local Active	When in "Local Only" Mode
Remote Active	When in "Remote Only Mode"
FVS	After the programmed delay time pulses are not received from flow sensor.
TFD	Tube failure is detected by sensors in the head
Both TFD/FVS	Either TFD or FVS system triggers
General Error	Motor Overload or other internal error

10.1 Control and Status Mapping for Industrial Protocols

Version 4 : February 20, 2024

Terminology: TFD/DFD = Tube/Diaphragm Failure Detection

FVS = Flow Verification System

LSB = Least Significant Byte

MSB = Most Significant Byte

Ethernet/IP and Profibus: Output Data (PLC to Pump) - Pump Control

DATA TYPE - BYTE (UINT8)		
Offset	Name	Description
0 - 1	Motor Percent Speed	Motor percent speed (up to 2 decimal places), with most significant Offset representing the whole number and least significant Offset representing the decimal number. (Eg. 50.15% => MSB = 50, LSB = 15)
2	Motor Direction	0 = Clockwise, 1 = Counter-clockwise.
3	Run State	Set the current run state of the pump by toggling the corresponding bits, where 0 = deactivated and 1 = activated. Bit 0 = Prime, Bit 1 = Start, Bit 2 = Stop
4	Reset Alarms	Reset alarms (TFD/DFD, FVS) on the pump. 0 = nothing, 1 = reset alarms. Only reset on a 0 -> 1 transition
5	Reset Tube Stats	Reset tube revolutions counter and hours ran
6	Cyclic Counter Direction	Cyclic counter direction (debugging purpose only). 0 = count up, 1 = count down
7	Cyclic Counter Speed	Cyclic counter speed (debugging purpose only). 0 = counter not incremented/decremented. Values > 0 = number of cycles it takes to increment/decrement the counter by one

DATA TYPE - WORD (UINT16)		
Offset	Name	Description
0	Motor Percent Speed	Motor percent speed (up to 2 decimal places), represented as a whole number (Eg. 50.15% => 5015)
1	Motor Direction	0 = Clockwise, 1 = Counter-clockwise.
2	Run State	Set the current run state of the pump by toggling the corresponding bits, where 0 = deactivated and 1 = activated. Bit 0 = Prime, Bit 1 = Start, Bit 2 = Stop
3	Reset Alarms	Reset alarms (TFD/DFD, FVS) on the pump. 0 = nothing, 1 = reset alarms. Only reset on a 0 -> 1 transition
4	Reset Tube Stats	Reset tube revolutions counter and hours ran
5	Cyclic Counter Direction	Cyclic counter direction (debugging purpose only). 0 = count up, 1 = count down
6	Cyclic Counter Speed	Cyclic counter speed (debugging purpose only). 0 = counter not incremented/decremented. Values > 0 = number of cycles it takes to increment/decrement the counter by one

10.1 Control and Status Mapping for Ethernet IP and Profibus DP

Ethernet/IP and Profibus: Input Data (Pump to PLC) - Pump Status

DATA TYPE - BYTE (UINT8)		
Offset	Name	Description
0	Run Status	Current run state of the pump represented by each bit, where 0 = Deactivated and 1 = Activated. Bit 0 = Prime, Bit 1 = Control Active, Bit 2 = Motor Running
1	Cover Status	0 = Cover Attached, 1 = Cover Detached
2	Motor Direction	0 = Clockwise, 1 = Counter-clockwise
3	TFD/DFD status	0 = No TFD/DFD alarm, 1 = TFD/DFD alarm
4	FVS status	0 = No FVS alarm, 1 = FVS alarm
5	Relay Output	Relay output statuses represented by each bit, where 0 = not triggered, and 1 = triggered. Bit 0 = Dry Contact 1, Bit 1 = Dry Contact 2, Bit 3 = Dry Contact 3, Bit 4 = Standard Relay
6 - 7	4-20 mA Output	Range: 400 - 2000 mA, where MSB represents the whole number and LSB represents the decimal number. Eg. 4.50 mA => Offset 6 = 4, Offset 7 = 50
8 - 9	Frequency Output	Range: 0 - 1000 Hz, where the MSB represent thousands and hundreds digits and LSB represents the tens and ones digits. Eg. 985 Hz => Offset 8 = 85, Offset 9 = 09
10 - 11	Motor Percent Speed	Motor percent speed (up to 2 decimal places), with most significant Offset representing the whole number and least significant Offset representing the decimal number. (Eg. 50.15% => MSB = 50, LSB = 15)
12 - 15	Firmware Version	Firmware version in semantic versioning format. Channel can be one of three values: 0 = stable, a(0x61) = alpha, b(0x62) = beta. Example: (1.0.5-beta => Offset 15: 1, Offset 14: 0, Offset 13: 5, Offset 12: b(0x62))
16 - 19	Tube Revolutions	Current tube revolution counter
20 - 23	Tube Hours	Number of hours ran for current tube
24 - 25	Cyclic Counter	Cyclic counter (debugging purpose only)

10.1 Control and Status Mapping for Ethernet IP and Profibus DP

DATA TYPE – WORD (UINT16)		
Offset	Name	Description
0	Run Status	Current run state of the pump represented by each bit, where 0 = Deactivated and 1 = Activated. Bit 0 = Prime, Bit 1 = Control Active, Bit 2 = Motor Running
1	Cover Status	0 = Cover Attached, 1 = Cover Detached
2	Motor Direction	0 = Clockwise, 1 = Counter-clockwise
3	TFD/DFD status	0 = No TFD/DFD alarm, 1 = TFD/DFD alarm
4	FVS status	0 = No FVS alarm, 1 = FVS alarm
5	Relay Output	Relay output statuses represented by each bit, where 0 = not triggered, and 1 = triggered. Bit 0 = Dry Contact 1, Bit 1 = Dry Contact 2, Bit 3 = Dry Contact 3, Bit 4 = Standard Relay
6	4-20 mA Output	4-20mA Output value, represented as whole number. Range: 400 - 2000 mA (Eg. 12.5mA => 1200)
7	Frequency Output	Frequency output value. Range: 0 - 1000 Hz
8	Motor Percent Speed	Motor percent speed (up to 2 decimal places), represented as a whole number (Eg. 50.15% => 5015)
9 - 10	Firmware Version	Firmware version in semantic versioning format. Channel can be one of three values: 0 = stable, a(0x61) = alpha, b(0x62) = beta. Example: 1.0.5-beta => Offset 10 (MSB): 1, Offset 10 (LSB): 0, Offset 9 (MSB): 5, Offset 9 (LSB): b(0x62)
11 - 12	Tube Revolutions	Current tube revolution counter
13 - 14	Tube Hours	Number of hours ran for current tube
15	Cyclic Counter	Cyclic counter (debugging purpose only)

10.2 Control and Status Mapping for Modbus TCP

Modbus TCP: Holding Registers (4x Reference, PLC to Pump, 16-bit word) - Pump Control

DATA TYPE – BYTE (UINT8)		
Register	Name	Description
0000	Motor Percent Speed	Motor percent speed (up to 2 decimal places), with MSB representing the whole number and LSB representing the decimal number. (Eg. 50.15% => MSB = 50, LSB = 15)
0001	Motor Direction and Run State	LSB is the motor direction where 0x00 = Clockwise, 0x01 = Counter-clockwise. MSB is to set the current run state of the pump by toggling the corresponding bits, where 0 = deactivated and 1 = activated. Bit 0 = Prime, Bit 1 = Start, Bit 2 = Stop
0002	Reset Alarms and Tube Stats	LSB is to reset alarms (TFD/DFD, FVS) on the pump, where 0x00 = nothing, 0x01 = reset alarms. Only reset on a 0 -> 1 transition. MSB is to reset tube revolutions counter and hours ran
0003	Cyclic Counter Direction and Speed	LSB is to set cyclic counter direction, where 0 = count up and 1 = count down. MSB is to set the cyclic counter speed, where 0 = counter not incremented/decremented. Values > 0 = number of cycles it takes to increment/decrement the counter by one. These are meant for debugging purposes only

DATA TYPE – WORD (UINT16)		
Register	Name	Description
0000	Motor Percent Speed	Motor percent speed (up to 2 decimal places) represented as a whole number. (eg. 50.15% => 5015)
0001	Motor Direction	Motor direction where 0x00 = Clockwise, 0x01 = Counter-clockwise
0002	Run State	Set the current run state of the pump by toggling the corresponding bits, where 0 = deactivated and 1 = activated. Bit 0 = Prime, Bit 1 = Start, Bit 2 = Stop
0003	Reset Alarms	Reset alarms (TFD/DFD, FVS) on the pump, where 0x00 = nothing, 0x01 = reset alarms. Only reset on a 0 -> 1 transition
0004	Tube Stats	Reset tube revolutions counter and hours ran
0005	Cyclic Counter Direction	Set cyclic counter direction, where 0 = count up and 1 = count down. These are meant for debugging purposes only
0006	Cyclic Counter Speed	Set the cyclic counter speed, where 0 = counter not incremented/decremented. Values > 0 = number of cycles it takes to increment/decrement the counter by one. These are meant for debugging purposes only

10.2 Control and Status Mapping for Modbus TCP

Modbus TCP: Input Registers (3x Reference, Pump to PLC, 16-bit word) - Pump Status

DATA TYPE - BYTE (UINT8)		
Register	Name	Description
0000	Run Status and Cover Status	LSB is the current run state of the pump, represented by each bit, where 0 = Deactivated and 1 = Activated. Bit 0 = Prime, Bit 1 = Control Active, Bit 2 = Motor Running. MSB is the cover status, where 0 = Cover Attached, 1 = Cover Detached
0001	Motor Direction and TFD/DFD status	LSB is the motor direction where 0 = Clockwise, 1 = Counter-clockwise. MSB is the TFD/DFD status where 0 = No TFD/DFD alarm, 1 = TFD/DFD alarm
0002	FVS status and Relay Output	LSB is the FVS status where 0 = No FVS alarm, 1 = FVS alarm. MSB is the relay output statuses represented by each bit, where 0 = not triggered, and 1 = triggered. Bit 0 = Dry Contact 1, Bit 1 = Dry Contact 2, Bit 3 = Dry Contact 3, Bit 4 = Standard Relay
0003	4-20 mA Output	Range: 400 - 2000 mA, where MSB represents the whole number and LSB represents the decimal number. Eg. 4.50 mA => MSB = 4, LSB = 50
0004	Frequency Output	Range: 0 - 1000 Hz, where the MSB represent thousands and hundreds digits and LSB represents the tens and ones digits. Eg. 985 Hz => Byte 8 = 85, Byte 9 = 09
0005	Motor Percent Speed	Motor percent speed (up to 2 decimal places), with MSB representing the whole number and LSB representing the decimal number. (Eg. 50.15% => MSB = 50, LSB = 15)
0006	Firmware Patch and Build	Firmware patch number and build channel. LSB is the firmware build channel. Channel can be one of three values: 0 = stable, a(0x61) = alpha, b(0x62) = beta. MSB is the firmware patch number Example: (1.0.5-beta => MSB is 5, LSB = b(0x62))
0007	Firmware Major and Minor Version	Firmware major and minor version. MSB is the major version and LSB is the minor version Example: (1.0.5-beta => MSB = 1 and LSB = 0)
0008 - 0009	Tube Revolutions	Current tube revolution counter
0010 - 0011	Tube Hours	Number of hours ran for current tube
0012	Cyclic Counter	Cyclic counter (debugging purpose only)

10.2 Control and Status Mapping for Modbus TCP

DATA TYPE - WORD (UINT16)		
Register	Name	Description
0000	Run Status	Run state of the pump, represented by each bit, where 0 = Deactivated and 1 = Activated. Bit 0 = Prime, Bit 1 = Control Active, Bit 2 = Motor Running
0001	Cover Status	Cover status, where 0 = Cover Attached, 1 = Cover Detached
0002	Motor Direction	Motor direction where 0 = Clockwise, 1 = Counter-clockwise
0003	TFD/DFD status	TFD/DFD status where 0 = No TFD/DFD alarm, 1 = TFD/DFD alarm
0004	FVS status	FVS status where 0 = No FVS alarm, 1 = FVS alarm
0005	Relay Output	Relay output statuses represented by each bit, where 0 = not triggered, and 1 = triggered. Bit 0 = Dry Contact 1, Bit 1 = Dry Contact 2, Bit 3 = Dry Contact 3, Bit 4 = Standard Relay
0006	4-20 mA Output	4-20mA Output value, represented as whole number. Range: 400 - 2000 mA
0007	Frequency Output	Frequency Output value. Range: 0 - 1000 Hz
0008	Motor Percent Speed	Motor percent speed (up to 2 decimal places) represented as a whole number. (Eg. 50.15% => 5015)
0009	Firmware Patch and Build	Firmware patch number and build channel. LSB is the firmware build channel. Channel can be one of three values: 0 = stable, a(0x61) = alpha, b(0x62) = beta. MSB is the firmware patch number Example: 1.0.5-beta => MSB is 5, LSB = b(0x62)
0010	Firmware Major and Minor Version	Firmware major and minor version. MSB is the major version and LSB is the minor version Example: (1.0.5-beta => MSB = 1 and LSB = 0)
0011 - 0012	Tube Revolutions	Current tube revolution counter
0012 - 0013	Tube Hours	Number of hours ran for current tube
0014	Cyclic Counter	Cyclic counter (debugging purpose only)

10.3 EtherNet/IP

This is used to configure the EtherNet/IP

Four values to be defined:

- 1) IP Address
 - 2) Subnet Mask
 - 3) Gateway
 - 4) Always On (Connection will remain active even when mode is inactive/OFF)
-

To Enable EtherNet/IP:

1 
Open the **App Drawer**

2 
Select **Industrial Protocols**

3 
Select **EtherNet/IP**

4
Pump will go to home screen

5 
Select **Settings** to input:

- IP Address
- Subnet Mask
- Gateway
- Always On

6
Confirm by pressing **Save**

10.4 Modbus TCP/IP

This is used to configure the Modbus TCP/IP

Three values to be defined:

- 1) IP Address
 - 2) Subnet Mask
 - 3) Gateway
 - 4) Always On (Connection will remain active even when mode is inactive/OFF)
-

To Enable Modbus TCP:

1 
Open the **App Drawer**

2 
Select **Industrial Protocols**

3 
Select **Modbus TCP/IP**

4
Pump will go to home screen

5 
Select **Settings** to input:

- IP Address
- Subnet Mask
- Gateway
- Always On

6
Confirm by pressing **Save**

10.5 Profibus DPV2

This is used to configure the Profibus

Three values to be defined:

- 1) Bus Address
- 2) Baud Rate
- 3) Watchdog Time
- 4) Always On (Connection will remain active even when mode is inactive/OFF)

To Enable Profibus:

1 
Open the **App Drawer**

2 
Select **Industrial Protocols**

3 
Select **Profibus**

4
Pump will go to home screen

5 
Select **Settings** to input:

- Bus Address
- Baud Rate
- Watchdog Time
- Always On

6
Confirm by pressing **Save**

11.1 Tube Info

This feature will display information regarding the tubing within the pump including:

- Tube type
 - Tube installation date
 - Tube run time & revolutions
 - Current maximum tube flow rate
-

To View The Tube Info:

1

Tap on the **Tube Info** text in the top portion of the screen

2

Tube info will be displayed

3

Click “reset” to reset the tube hours and revolutions

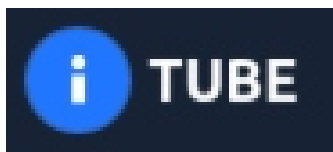

11.2 Tube Calibration

This feature allows the user to calibrate the pump's indicated flow rate to the system

To Calibrate Your Tube:

1

On the home screen select the **Calibration Icon**



2

Enter values:

- Pump Speed (RPM)
- Run Time (seconds)

3

Select **Start** to begin

4

Select **Start**

5

Enter the measured flow rate into the field

6

Confirm by selecting **Save**

12.1 Pump Name

This is to change the name of the pump that is displayed on the home screen.

To Input Pump Name:

1 
Open the **App Drawer**

2 
Open **Settings**

3 
Open **System**

4
Select "**Pump Name**"

5
Enter desired **Pump Name**

6
Confirm by pressing **OK**

12.2 Unit of Volume

This is to change the units of volume that is displayed.

To Input Units of Volume:

1 
Open the **App Drawer**

2 
Open **Settings**

3 
Open **System**

4
Select **Unit of Volume**

5 Select desired **Units of Volume**

6 Confirm by pressing **OK**

- Milliliters
- Ounces
- Liters

12.3 Unit of Time

This will change the Unit of Time that is displayed for the flow rate

To Input Unit of Time:

1 
Open the **App Drawer**

2 
Open **Settings**

3 
Open **System**

4
Select **Unit of Time**

5
Select **Desired Time**

- Minutes (mL & ounces only)
- Hours
- Days (Gallons only)

6
Confirm by pressing **OK**

12.4 Chemical Name

This is used to change the Chemical Name that is displayed on the home screen.

To Input a Chemical Name:

1 
Open the **App Drawer**

2 
Open **Settings**

3 
Open **System**

4
Select "**Chemical Name**"

5
Enter desired **Chemical Name**

6
Confirm by pressing **OK**

12.5 Max Motor RPM Cut-off

This will limit the maximum speed (RPM) that the pump can run, regardless of run mode.

To Input the Max Motor RPM:

1 
Open the **App Drawer**

2 
Open **Settings**

3 
Open **System**

4
Select Max Motor RPM Cut-off

5
Select **Desired RPM**

6
Confirm by pressing **OK**

12.6 Set Language

This setting is used to change the system language.

To Input a Language:

1 
Open the **App Drawer**

2 
Open **Settings**

3 
Open **System**

4
Select **Locale**

5
Select **Desired Language**
·English
·Deutch
·Español
·Français
·Portugues

6
Confirm by pressing **OK**

12.7 Pump Rotation Direction

This setting is used to change the rotational direction of pump. In most applications, the tube will fail by developing a small leak in the outlet side (pressure side) of the tube assembly. By reversing the roller rotation, the wear point in the tube is moved to the opposite side to the pump tube assembly, increasing the life of the tube.

Important! Changing the rotational direction of the pump reverses the inlet & outlet sides.

To Change The Direction Of The Pump Rotation

1 
Open the **App Drawer**

2 
Open **Settings**

3 
Open **System**

4
Select **Pump Direction**

5
Select **Desired Rotation**

6
Confirm by pressing **OK**

*Clockwise

*Counter Clockwise

Disconnect power from the pump. Carefully purge any pressure in the discharge line of the pump. Disconnect the suction end tubing/piping and the discharge end tubing/piping from the pump head tubing.

IMPORTANT! Swap sides of the suction (inlet) and discharge (outlet) tubing/piping. There is no need to remove the pump head cover.

NOTE: The pump tube will form a natural U-shaped curve. Do not attempt to install the pump tube against the natural U-shape direction as damage to the tube can result.

WARNING: If using **Industrial Protocols (Modbus TCP, Ethernet IP, Profibus)** to control the direction of rotation, the rotation direction may be different when switching to “LOCAL ONLY” or “OFF” Mode.



12.8 Resume Operation on Start-Up

This setting is used to choose whether to resume operation in the same state prior to turning off pump, or after power interruption.

Note: Pump will require approx. 30 seconds for initialization before resuming operation.

Default settings: Enabled

Disabled = Pump will be stopped at Start-Up

To Modify Setting:

1 
Open the **App Drawer**

2 
Open **Settings**

3 
Open **System**

4
Scroll down to **Resume Operation**

5
Select **Enable /Disable**

6
Confirm by pressing **Save**

12.9 Factory Reset

This setting is used to factory reset the pump. This will erase all of the configurations and restore the pump to it's original configuration when it left Blue-White factory.

To Conduct A Factory Reset:

1 
Open the **App Drawer**

2 
Open **Settings**

3 
Open **System**

4
Select **Reset to Factory Defaults**

5
Confirm by pressing **Continue**

6
Pump will **Reboot** and run through the initial setup process

Lost password? Email customerservice@blue-white.com to have your password reset

12.10 System Time

This setting is used to change the local time that is displayed.

To Input The System Time:

1



Select the **Time** in the upper right hand corner

2

Select **Desired Hour**

3

Select **Desired Minute**

4

Select **AM or PM**

5

Confirm by pressing **OK**

12.11 Display Flow Rate / RPM / % Motor Speed / Remote input (4-20 mA input / Hz / Pulses)

To change the display between Flow Rate, RPM, % Motor Speed, or Remote input (4-20 mA, Hz frequency, or # of pulses), press the display where value is shown. The display value will change with each press.

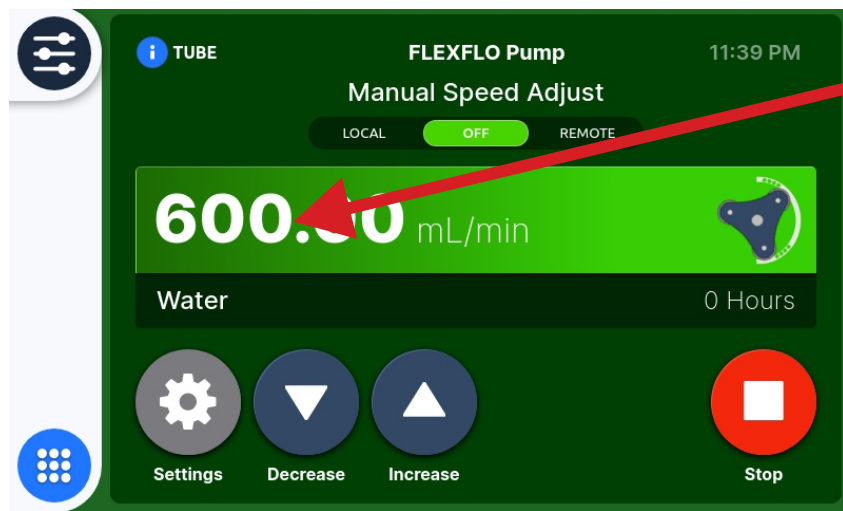

Press here to change display

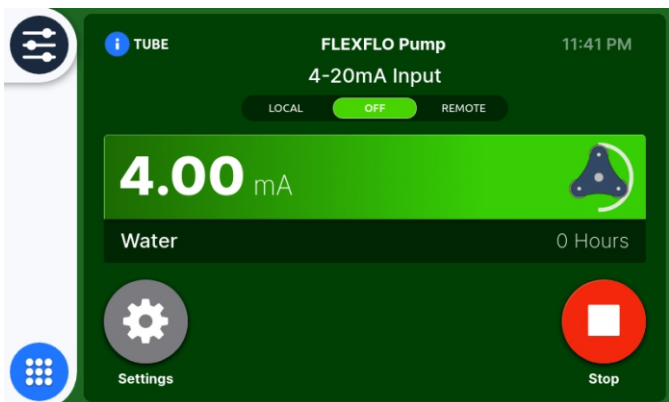
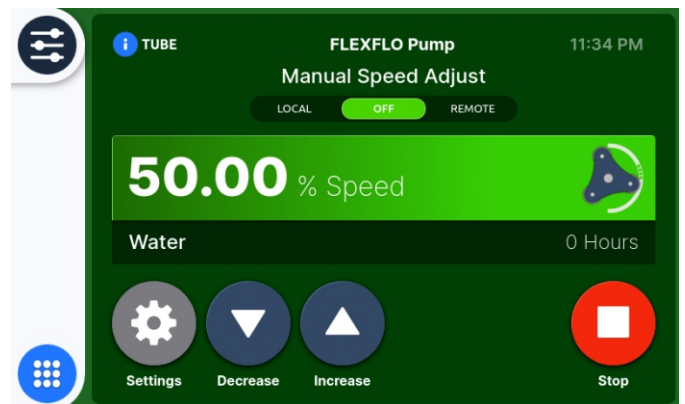
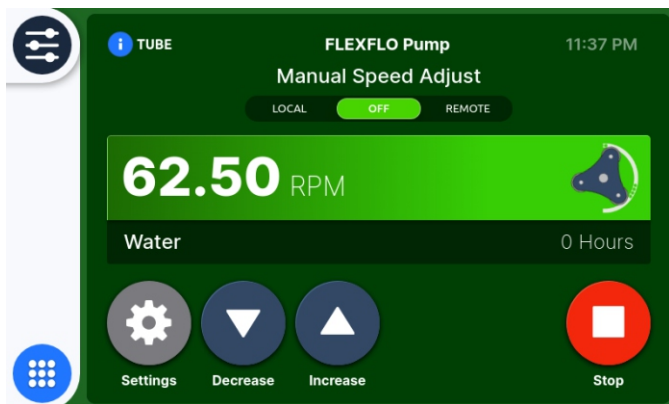

13.1 SYSTEM INFORMATION

This is to view the System Information

Information to be displayed:

- Pump Name
- Chemical Name
- Firmware Version
- System Build
- Manufactured Data & Time
- Serial Number
- Model
- I/O Port Firmware Version
- Motor Firmware Version
- Industrial Protocol Firmware Version
- Lifetime Run Hours & Revolutions

To View The System Information:

1



Open the **App Drawer**

2



Select **System Information**

13.2 Firmware Update

To update the firmware for your pump you first need to download and install Blue-Central® which is available at:

<https://www.blue-white.com/resources/>



To Update The System Firmware:

- 1**
Plug pump into a computer via USB A to USB C cable and open Blue-Central® program
- 2**
Select firmware tab and select “Start Upgrade”. (If this is the first time using Blue Central, it may takes a few minutes to download firmware, depending on your internet speed.)
- 3**
The firmware upgrade box will appear showing the progress of the download. (This should take 1-3 minutes)
- 4**
Once the download is complete select “Close” to exit screen.
- 5**
Follow instruction on pump screen to upgrade the firmware. You can choose to update at a later time if the pump is currently running.
- 6**
If you choose to update at a later time, you can initiate the update later by going to the “System” key and selecting “Update” at the bottom of the screen.

CAUTION

Always wear protective clothing, face shield, safety glasses and gloves when working on or near your metering pump. Additional precautions should be taken depending on solution being pumped. Refer to MSDS precautions from your solution supplier.

14.1 Routine Inspection and Maintenance

The pump requires very little maintenance. However, the pump and all accessories should be checked weekly. This is especially important when pumping aggressive chemicals. Inspect all components for signs of leaking, swelling, cracking, discoloration or corrosion. Replace worn or damaged components immediately.

Cracking, crazing, discoloration and the like during first week of operation are signs of severe chemical attack. If this occurs, immediately remove chemical from pump. Determine which parts are being attacked and replace them with parts that have been manufactured using more suitable materials.

14.2 How to Clean and Lubricate the Pump

When changing the pump tube assembly, the pump head chamber, roller assembly and pump head cover should be wiped free of any dirt and debris.



100% silicon lubrication may be used on the roller assembly.

Refer to www.blue-white.com/resources/videos for roller assembly maintenance video instructions.



Periodically clean the back flow prevention check valve assembly, especially when injecting fluids that calcify such as sodium hypochlorite. These lime deposits and other build ups can clog the fitting, increasing the back pressure at the pump (reducing tube life) and interfering with check valve operation.

The motor does not require maintenance or lubrication.

CAUTION 	Prior to service, pump clean water through the pump and suction / discharge line to remove chemical.
CAUTION 	Always wear protective clothing, face shield, safety glasses and gloves when working on or near your metering pump. Additional precautions should be taken depending on solution being pumped. Refer to MSDS precautions from your solution supplier.

14.3 Removing Pump Head Cover and Tubing Replacement

The pump requires very little maintenance. However, the pump and all accessories should be checked weekly, and cleaned thoroughly whenever a tube is replaced. This is especially important when pumping aggressive chemicals.

1. Remove the Pump Head Cover by unscrewing the Thumb Screws. Pull out the Pump Head Cover.
2. The pump will detect that the Pump Head Cover is removed and enter MAINTENANCE MODE.
3. Rotor will rotate at a maximum of 6 RPM for your safety.
4. Press the START button and rotate until one of the rollers is in the 9 O'clock position.
5. Rotate the Spider Ring and remove.
6. Remove Roller (pinch or guide) by sliding it off the rotor.
7. Run pump and repeat process with other rollers.
8. Remove Tube and clean pump head. Clean rollers, as necessary.
9. Install new Tube.
10. Install Roller, and rotate pump head to install remaining Rollers. Be sure pinch rollers are opposite of other.
11. Once all rollers are installed, attach and tighten the Spider Ring.
12. Re-attach Pump Head Cover with Thumb Screws.
13. Confirm Tube replacement and press Save. Pump is now ready for use.

For more information on tube replacement scan the QR Code here, or go to www.blue-white.com/bw-videos/the-blue-white-academy-how-to-replace-the-a4-m4-tubing/



14.4 Pump Head and Roller Exploded Views

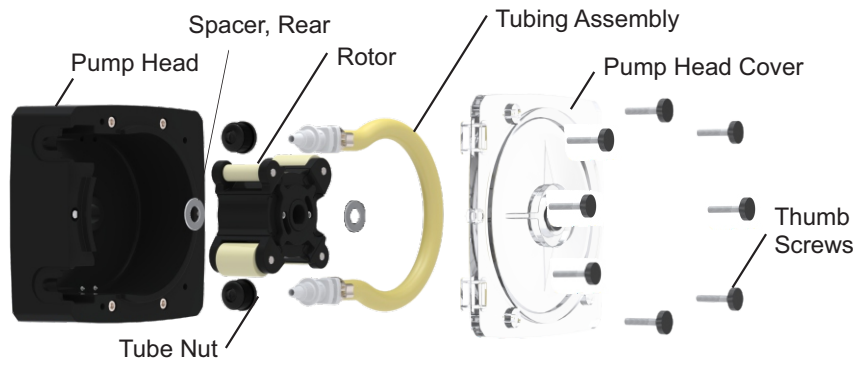

Pump Head

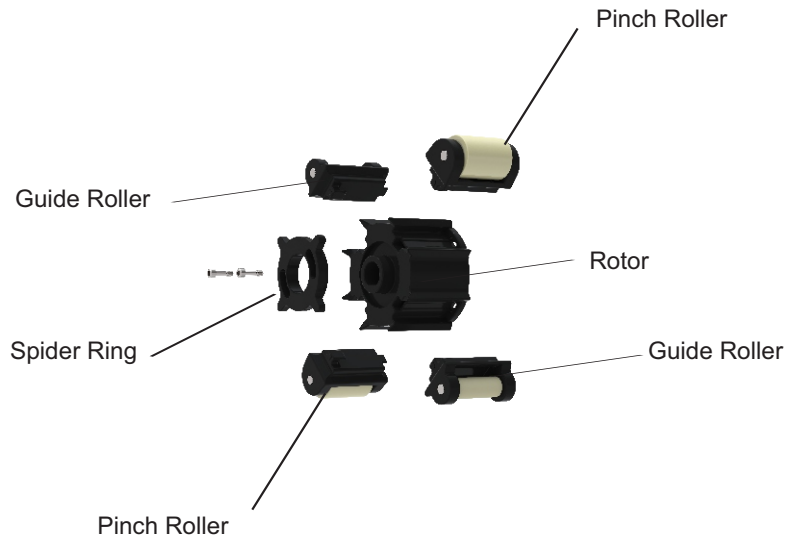

Roller Assembly

14.5 TFD

This pump is equipped with a Tube Failure Detecting System which is designed to stop the pump and provide an output alarm (see Output menu) in the event pump the tube should rupture and chemical enters the pump head.

This patented system is capable of detecting the presence of a large number of chemicals including Sodium Hypochlorite (Chlorine), Hydrochloric (muriatic) Acid, Sodium Hydroxide, and many others. The system will not be triggered by water (rain, condensation, etc.) or silicone oil (roller and tubing lubricant).

If a TFD alarm occurs, the pump will stop and the screen will turn red with “TFD”

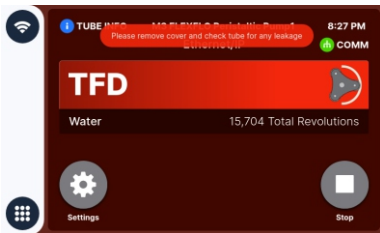

Please refer to Section 14 for instructions on replacing tube and cleaning the pump head. Proper cleaning after tube leaks are critical for maintaining the best possible tube and roller life.

Confirming Chemical Detection

To determine if a chemical will be detected by the system:

1. Remove the pump head cover, and the pump tube and roller assembly.
2. Place a small amount of chemical in the bottom of the pump head that is enough to cover the sensors.
3. Reinstall **only** the pump head cover.
4. Turn on the pump by pressing the START button.

NOTE: If the TFD system **detects** a chemical, the pump will stop after a two-second confirmation period.

NOTE: If the TFD system **does not detect** a chemical, the pump will continue to operate after the confirmation period.

5. Carefully clean the chemical out of the pump head. Ensure to remove all the chemical traces from the sensor probes.
6. Replace the roller assembly and tubing.
7. Reinstall the pump head cover.
8. Follow instructions on pump to clear alarm condition.
9. Restart the pump.

14.6 Predictive Tube Failure Detection (TFD)

This pump is equipped with a Predictive Tube Failure Detection feature that uses tube replacement history to let the operator know when a tube failure may occur. This feature must be activated in the Settings Tab. When activated before any tube failures, the default setting for the installed tube will be used.

When enabled, a warning will be display when a tube is approaching its previous failure threshold. This threshold is based on an average of tube replacement and TFD event history.

To Modify Setting:

1



Open the **App Drawer**

2



Open **Settings**

3



Open Predictive TFD

4

Enable the Alarm

5

Confirm by pressing **Save**

15.1 Replacement Parts

A4/M4 Replacement Parts

Pump Head Components		Part No.	QTY Req'd
1	Spacer	90011-217	2
2	Complete Roller Assembly		1
	NL / NP	A4-MNL-R	
	TH / TK / TTK / THH	A4-MTH-R	
	NH / NK / NHH / NHL / NHHL	A4-MNH-R	
	NKL / NKKL	A4-MNKL-R	
	GH / GK / GKK	A4-MGH-R	
3	Tubing (Reference Tubing Matrix)		1
4	Pump Head Cover	A4-SXX-C	1
5	Thumb Screws	90011-183	8
6	Shaft Extension	90007-128	1

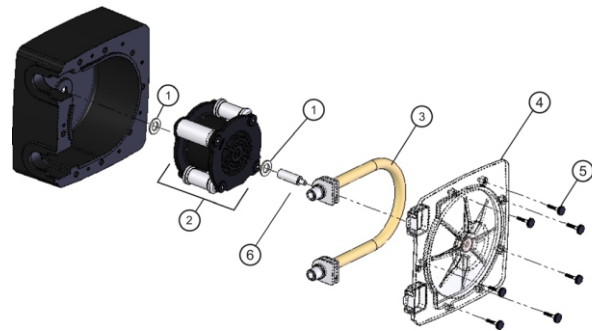

*Pump Head not for sale. For more information please contact a local sales representative.

Roller Assembly Parts		Part No.	QTY Req'd
7	A4 ROTOR BODY*	N/A	1
8	SPIDER RING*	76002-038	1
9	10-32 CAPTIVE SCREW*	90011-341	2
	*A4 ROTOR ASSY (7,8, and 9)	A4-SXX-RB	1
10	ARM ROLLER GUIDE	71010-771	2
11	ARM ROLLER		
	NL / NP	71010-766	2
	TH / TK / TKL / THH	71010-767	2
	NH / NK / NHH / NHL / NHHL	71010-768	2
	NKL / NKKL	71010-769	2
	GH / GHH / GK /GKK	71010-770	2

*Available as part of Rotor Assy A4-SXX-RB

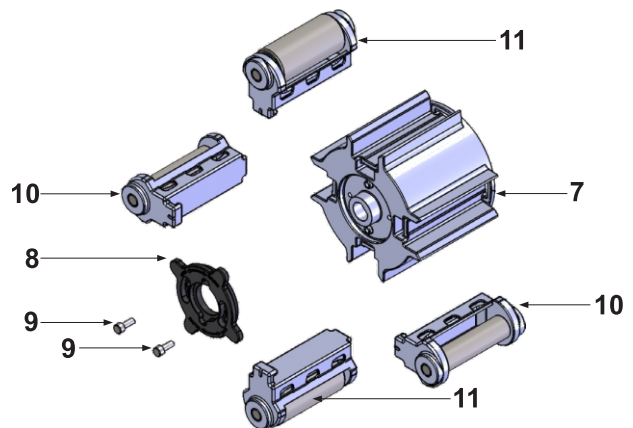

Quick Disconnect Fittings*		Part No.	QTY Req'd
12	Quick Disconnect Fittings		1
	.50" M/NPT FKM	KIT-QMV	
	.50" M/NPT EP	KIT-QME	
	.50" M/NPT Aflas	KIT-QMA	
	.50" Barb FKM	KIT-QBV	
	.50" Barb EP	KIT-QBE	
	.50" Barb Aflas	KIT-QBA	



12

*For use only with "Q" style pump tubes

Miscellaneous Parts*		Part No.	QTY Req'd
A	Stainless Steel Mounting Bracket	72000-379	1
B	Stainless Steel Mounting Bracket (Extended)	72000-380	1
C	Rubber Feet	90003-561	1

*Sold Separately



A



B



C

15.2 Tube Matrix

FLEXFLO® Tube Assembly Part Number

A4	Tubing (for use on A4, A4S, M4, M4S pumps)					
Inlet/Outlet Connection Size, Connection Type, Connection Material						
M	1/2" Male NPT Fitting, Natural PVDF (Kynar)					
B	1/2" ID Tubing Barb Fitting, Natural PVDF (Kynar)					
Q	Quick Disconnect, Natural PVDF (Kynar). NP flow rate reduced 16.5% with Quick Disconnect connections (Valves sold separately)					
C	1/2" - 3/4" Tri-clamp connections, Natural PVDF (Kynar)					
MB	1/2" Male BSPT Fitting, Natural PVDF (Kynar)					
Pump Tube Material, Pump Tube Size						
GH	Flex-A-Thane® .312 ID		NHHL	Flex-A-Prene® .250 ID (Dual Tube)		
GHH	Flex-A-Thane® .312 ID (Dual Tube)		NK	Flex-A-Prene® .375 ID		
GK	Flex-A-Thane® .375 ID		NL	Flex-A-Prene® .500 ID		
GKK	Flex-A-Thane® .375 ID (Dual Tube)		NP	Flex-A-Prene® .750 ID		
NH	Flex-A-Prene® .250 ID		TH	Flex-A-Chem® .250 ID		
NHL	Flex-A-Prene® .250 ID		TK	Flex-A-Chem® .375 ID		
NHH	Flex-A-Prene® .250 ID (Dual Tube)		TKK	Flex-A-Chem® .375 ID (Dual Tube)		
A4	-	M	NH	-	T	Tube Sample Model Number

Output Specifications

Tube Material / Size	Feed Rate			Max Speed	Max Pressure	Max Temperature
	GPH	LPH	mL/Min	RPM	PSI (bar)	°F (°C)
Flex-A-Thane® Tube						
GH	Up to 39.6	Up to 150	Up to 2500	125	65 (4.5)	130 (54)
GHH	Up to 71.0	Up to 268	Up to 4479	125	65 (4.5)	130 (54)
GK	Up to 55.5	Up to 210	Up to 3500	125	65 (4.5)	130 (54)
GKK	Up to 100	Up to 378	Up to 6300	125	65 (4.5)	130 (54)
Flex-A-Prene® Tube						
NH	Up to 28.5	Up to 108	Up to 1800	125	125 (8.6)	185 (85)
NHL	Up to 28.5	Up to 108	Up to 1800	125	65 (4.5)	185 (85)
NHH	Up to 54.0	Up to 204	Up to 3400	125	100 (6.9)	185 (85)
NHHL	Up to 54.0	Up to 204	Up to 3400	125	65 (4.5)	185 (85)
NK	Up to 50.7	Up to 192	Up to 3200	125	80 (5.5)	185 (85)
NL	Up to 100	Up to 378	Up to 6300	125	50 (3.4)	185 (85)
NP	Up to 158.5	Up to 600	Up to 10000	125	30 (2.1)	185 (85)
Flex-A-Chem® Tube						
TH	Up to 25.4	Up to 96	Up to 1603	125	30 (2.1)	130 (54)
TK	Up to 54.0	Up to 204	Up to 3400	125	30 (2.1)	130 (54)
TKK	Up to 126	Up to 477	Up to 8000	125	30 (2.1)	130 (54)

16.0 ACCESSORIES

The following accessories are available for the M4 FLEXFLO® Peristaltic Metering Pump. Please visit Blue-white.com for more information. All accessories are sold separately.



KIT-M12

Kit contains: Two M12 cables. 10 foot length.

KIT-M12-2-15 15 foot length.
KIT-M12-2-30 30 foot length.

KIT-M12 WIRING INSTRUCTIONS		
DIAGRAM	PIN #	WIRE COLOR
	PIN 1	BROWN
	PIN 2	WHITE
	PIN 3	BLUE
	PIN 4	BLACK
	PIN 5	GRAY

NOTE: THIS DIAGRAM IS FOR THE PUMP'S M12 PORT



CABLE-UAC

Kit contains: One 3' USB-A to USB-C cable. Required for Firmware updates.



KIT-DP3

Kit contains: One 3' profibus cable.



KIT-QMV

Kit contains: One Quick Connect Inlet with .50" M/NPT (assembled with FKM O-rings) and One Quick Connect Outlet with .50" M/NPT (assembled with FKM O-rings)

*KIT-QME for EP O-rings
KIT-QMA for Aflas O-rings



KIT-QBV

Kit contains: One Quick Connect Inlet with .50" hose barb connection (assembled with FKM O-rings), One Quick Connect Inlet with .50" hose barb connection (assembled with FKM O-rings) and two #5 Clamps.

*KIT-QBE for EP O-rings
KIT-QBA for Aflas O-rings



KIT-PSM

Kit contains: One HDPE Bracket, (4) 3/8" x 2-3/4" long dia anchor bolts.



POWER CORDS - DETACHABLE

90010-663 115V/60Hz NEMA 5/15
90010-664 220V/50Hz CEE 7/V11
90010-665 230V/50Hz BS 1363/A
90010-666 240V/50Hz AS 3112
90010-696 230V/60Hz NEMA 6/15
90010-711 115V/60Hz NEMA 5/15 (Lockable)

**PAGE INTENTIONALLY
LEFT BLANK**

17.0 WARRANTY

17.1 LIMITED WARRANTY

Your new FLEXFLO pump is a quality product and is warranted for 60 months from date of purchase (proof of purchase is required). The pump will be repaired or replaced at our discretion. Failure must have occurred due to defect in material or workmanship and not as a result of operation of the product other than in normal operation as defined in the pump manual. Warranty status is determined by the pump's serial label and the sales invoice or receipt. The serial label must be on the pump and legible. The warranty status of the pump will be verified by Blue-White or a factory authorized service center.

Pump Head and roller assembly is warranted against damage from chemical attack when proper TFD (Tube Failure Detection) system instructions and maintenance procedures are followed.

17.2 WHAT IS NOT COVERED

- Pump Tube Assemblies and rubber components – They are perishable and require periodic replacement.
- Pump removal, or re-installation, and any related labor charge.
- Freight to the factory, or service center.
- Pumps that have been tampered with, or in pieces.
- Damage to the pump that results from misuse, carelessness such as chemical spills on the enclosure, abuse, lack of maintenance, or alteration which is out of our control.
- Pumps damaged by faulty wiring, power surges or acts of nature.

17.3 PROCEDURE FOR IN WARRANTY REPAIR

Contact the factory to obtain a RMA (Return Material Authorization) number. Carefully pack the pump to be repaired. It is recommended to include foot strainer and injection/check valve fitting since these devices may be clogged and part of the problem. Please enclose a brief description of the problem as well as the original invoice or sales receipt, or copy showing the date of purchase. Prepay all shipping costs. COD shipments will not be accepted. Warranty service must be performed by the factory or an authorized service center. Damage caused by improper packaging is the responsibility of the sender. When In-Warranty repair or replacement is completed, the factory pays for return shipping to the dealer or customer.

17.4 PRODUCT USE WARNING

Blue-White products are manufactured to meet the highest quality standards in the industry. Each product instruction manual includes a description of the associated product warranty and provides the user with important safety information. Purchasers, installers, and operators of Blue-White products should take the time to inform themselves about the safe operation of these products. In addition, Customers are expected to do their own due diligence regarding which products and materials are best suited for their intended applications. Blue-White is pleased to assist in this effort but does not guarantee the suitability of any particular product for any specific application as Blue-White does not have the same degree of familiarity with the application that the customer/end user has. While Blue-White will honor all of its product warranties according to their terms and conditions, Blue-White shall only be obligated to repair or replace its defective parts or products in accordance with the associated product warranties. **BLUE-WHITE SHALL NOT BE LIABLE EITHER IN TORT OR IN CONTRACT FOR ANY LOSS OR DAMAGE WHETHER DIRECT, INDIRECT, INCIDENTAL, OR CONSEQUENTIAL, ARISING OUT OF OR RELATED TO THE FAILURE OF ANY OF ITS PARTS OR PRODUCTS OR OF THEIR UNSUITABILITY FOR A GIVEN PURPOSE OR APPLICATION.**

17.5 CHEMICAL RESISTANCE WARNING

Blue-White offers a wide variety of wetted parts. Purchasers, installers, and operators of Blue-White products must be well informed and aware of the precautions to be taken when injecting or measuring various chemicals, especially those considered to be irritants, contaminants or hazardous. Customers are expected to do their own due diligence regarding which products and materials are best suited for their applications, particularly as it may relate to the potential effects of certain chemicals on Blue-White products and the potential for adverse chemical interactions. Blue-White tests its products with water only. The chemical resistance information included in this instruction manual was supplied to Blue-White by reputable sources, but Blue-White is not able to vouch for the accuracy or completeness thereof. While Blue-White will honor all of its product warranties according to their terms and conditions, Blue-White shall only be obligated to repair or replace its defective parts or products in accordance with the associated product warranties. **BLUE-WHITE SHALL NOT BE LIABLE EITHER IN TORT OR IN CONTRACT FOR ANY LOSS OR DAMAGE, WHETHER DIRECT, INDIRECT, INCIDENTAL, OR CONSEQUENTIAL, ARISING OUT OF OR RELATED TO THE USE OF CHEMICALS IN CONNECTION WITH ANY BLUE-WHITE PRODUCTS.**

APPENDIX A: ACRONYMS

°C	Celsius	RMA	Return Material Authorization
°F	Fahrenheit	RPM	Revolutions per minute
AC	Alternating current	SIP	Steam-in-place
bar	Unit of pressure	SS	Solid state
CIP	Clean-in-place	TFD+	Enhanced Tube Failure Detection
cm	Centimeters	TFE/P	Tetrafluoroethylene propylene
COD	Cash on Delivery	UL	Underwriters Laboratories
D	Depth	US	United States
DC	Direct current	V	Volt
EEE	Electrical and electronic equipment	W	Watt
EP	Ethylene propylene	W	Width
ETL	Electrical Testing Labs/Intertek	WEEE	Waste Electrical and Electronic Equipment
EU	European Union		
FDA	Food and Drug Administration		
FKM	Fluoroelastomer		
FVS	Flow Verification Sensor		
GF	Glass fiber		
GPD	Gallons per day		
GPH	Gallons per hour		
H	Height		
Hz	Hertz		
ID	Inside diameter		
IO	Input/Output		
Kg	Kilogram		
lb.	Pound		
LLDPE	Linear low-density polyethylene		
LPH	Liters per hour		
mA	Milliampere		
min	Minute		
mL	Milliliters		
MSDS	Material Safety Data Sheet		
N.C.	Normally Close		
N.O.	Normally Open		
NPT	National Pipe Thread		
NSF	National Sanitation Foundation		
OD	Outside diameter		
P.N.	Part Number		
PBT	Polybutylene Terephthalate		
PE	Polyethylene		
PSI	Pounds per Square Inch		
PVC	Polyvinyl chloride		
PVDF	Polyvinylidene fluoride		
RCD	Residual-current device		
Rev.	Revision		

Model Number Matrix

M4

FLEXFLO® Model Number

M4	FLEXFLO® M4 Peristaltic Metering Pump							
Power Cord (operating voltage requirement 96VAC to 264VAC)								
4	115V / 60HZ, power cord NEMA 5/15 plug (US)							
6	220V / 50HZ, power cord CEE 7/VI plug (EU)							
X	No Power Cord							
Inlet/Outlet Connection Size, Connection Type, Connection Material								
M	1/2" Male NPT Fitting, Natural PVDF (Kynar)							
B	1/2" ID Tubing Barb Fitting, Natural PVDF (Kynar)							
C	1/2" - 3/4" Tri-clamp connections, Natural PVDF (Kynar)							
Q	Quick Disconnect, Natural PVDF (Kynar), NP flow rate reduced 16.5% with Quick Disconnect connections (Valves sold separately)							
MB	1/2" Male BSPT Fitting, Natural PVDF (Kynar)							
Pump Tube Material, Pump Tube Size NOTE: * = Dual tube								
NH	Flex-A-Prene® .250 ID .01–28.5 GPH 125 PSI	GH	Flex-A-Thane® .312 ID .01–39.6 GPH 65 PSI					
NHH*	Flex-A-Prene® .250 ID .02–54.0 GPH 100 PSI	GHH*	Flex-A-Thane® .312 ID .03–71 GPH 65 PSI					
NHHL*	Flex-A-Prene® .250 ID .02–54.0 GPH 65 PSI	GK	Flex-A-Thane® .375 ID .02–55.5 GPH 65 PSI					
NHL	Flex-A-Prene® .250 ID .01–28.5 GPH 65 PSI	GKK*	Flex-A-Thane® .375 ID .04–100 GPH 65 PSI					
NK	Flex-A-Prene® .375 ID .02–50.7 GPH 80 PSI	TH	Flex-A-Chem® .250 ID .01–25.4 GPH 30 PSI					
NL	Flex-A-Prene® .500 ID .04–100.0 GPH 50 PSI	TK	Flex-A-Chem® .375 ID .02–54.0 GPH 30 PSI					
NP	Flex-A-Prene® .750 ID .06–158.5 GPH 30 PSI	TKK*	Flex-A-Chem® .375 ID .05–126 GPH 30 PSI					
Pumphead Orientation								
(Blank)	Standard - Left facing							
R	Right facing pumphead							
D	Down facing pumphead							
M4	S	2	4	-	M	NH	R	Sample Model Number



Users of electrical and electronic equipment (EEE) with the WEEE marking per Annex IV of the WEEE Directive must not dispose of end of life EEE as unsorted municipal waste, but use the collection framework available to them for the return, recycle, recovery of WEEE and minimize any potential effects of EEE on the environment and human health due to the presence of hazardous substances. The WEEE marking applies only to countries within the European Union (EU) and Norway. Appliances are labeled in accordance with European Directive 2002/96/EC.

Contact your local waste recovery agency for a *Designated Collection Facility* in your area.

Blue-White[®]

5300 Business Drive
Huntington Beach, CA 92649
USA

TEL: 714-893-8529
FAX: 714-894-9492

www.blue-white.com
sales@blue-white.com
customerservice@blue-white.com